

APPLICATION MANUAL



KEB COMBIVERT F5-BASIC / GENERAL 2.3

Charge 40,- Euro



Chapter	Section	Page	Date	Name:Basis	©	KEB Antriebstechnik, 2002 All Rights reserved
1	1	2	28.02.02	KEB COMBIVERT F5-G / B		

1. Introduction	This chapter shall allow a fast access to the wanted information. It consists of contents, index and search criterion.
2. Summary	Here the inverter and its features as well as the operating conditions and application purpose are described.
3. Hardware	Description of hardware, technical data of the inverter as well as connection of power and control terminals.
4. Operation	The basic operation of the KEB COMBIVERT like password input, parameter and set selection.
5. Parameter	A list of all parameters classified according to parameter groups. The parameter description comprises addresses, value ranges and references with regard to the functions for which they are used.
6. Functions	To make the programming easier all inverter functions and the parameters belonging to it are comprised in this chapter.
7. Start-up	Gives support with regard to the initial start-up and shows possibilities and techniques for the optimization of the drive.
8. Special Operation	Describes special operating modes, like e.g. DC-coupling.
9. Error Assistance	Avoidance of errors, evaluation of error messages and elimination of the causes.
10. Project Planning	Survey of the possible interconnection in existing networks; address and value table for the implementation in own protocols.
11. Networks	Survey of the possible interconnection of the KEB COMBIVERT in existing networks.
12. Annex	Everything that didn't fit anywhere else or what we didn't think of earlier.

Chapter	Section	Page	Date	Name:Basis	©	KEB Antriebstechnik, 2002 All Rights reserved
1	1	4	28.02.02	KEB COMBIVERT F5-G / B		

1. Introduction**2. Summary****3. Hardware****4. Operation****5. Parameter****6. Functions****7. Start-up****8. Special Operation****9. Error Assistance****10. Project Planning****11. Networks****12. Annex****1.1 General**

1.1.1	Table of Contents	7
1.1.2	Preface	13
1.1.3	Record of Changes	15

Chapter	Section	Page	Date	Name:Basis	©	KEB Antriebstechnik, 2002 All Rights reserved
1	1	6	28.02.02	KEB COMBIVERT F5-G / B		

1. Introduction

1.1 General

1.1.1 Table of Contents

1.	Introduction	1.1.7
1.1	General	1.1.7
1.1.1	Table of Contents	1.1.7
1.1.2	Preface	1.1.13
1.1.3	Record of Changes	1.1.15
2.	Overview	2.1.3
2.1	Product Description	2.1.3
2.1.1	Features of KEB COMBIVERT	2.1.3
2.1.2	Function Principle	2.1.3
2.1.3	Application as directed	2.1.4
2.1.4	Type Code	2.1.5
2.1.5	Validity of Specifications	2.1.6
2.1.6	Unit Sizes 230V-Class	2.1.6
2.1.7	Unit Sizes 400V-Class	2.1.7
2.1.8	Overload curve	2.1.12
2.1.9	Overload protection in the lower speed range	2.1.12
3.	Hardware	3.1.3
3.1	Control Units	3.1.3
3.1.1	Survey	3.1.3
3.1.2	Terminal strip X2A	3.1.4
3.1.3	Connection of the control	3.1.5
3.1.4	Digital inputs	3.1.5
3.1.5	Analog inputs	3.1.6
3.1.6	Voltage Input / External Power Supply	3.1.7
3.1.7	Digital Outputs	3.1.7
3.1.8	Relay Outputs	3.1.7
3.1.9	Analog Outputs	3.1.8
3.1.10	Voltage Output	3.1.8
4.	Operation	4.1.3
4.1	Fundamentals	4.1.3
4.1.1	Parameters,	4.1.3
4.1.2	Selection of a Parameter	4.1.4
4.1.3	Adjustment of Parameter Values	4.1.4
4.1.4	ENTER-Parameter	4.1.4
4.1.5	Non-programmable Parameters	4.1.5
4.1.6	Resetting of Error Messages	4.1.5
4.1.7	Resetting of Peak Values	4.1.5
4.1.8	Acknowledgement of Status Signals	4.1.5

4.2	Password Structure	4.2.3
4.2.1	Password Levels	4.2.3
4.2.2	Passwords	4.2.4
4.2.3	Changing of Password Level.....	4.2.4
4.3	CP-Parameter	4.3.3
4.3.1	Operation in CP-Mode.....	4.3.3
4.3.2	Factory Setting	4.3.4
4.3.3	Password Input	4.3.5
4.3.4	Operating Display.....	4.3.5
4.3.5	Basic Adjustment of the Drive.....	4.3.7
4.3.6	Special Adjustments.....	4.3.10
4.4	Drive-Mode	4.4.3
4.4.1	Adjustment Possibilities	4.4.3
4.4.2	Display and Keyboard	4.4.3
4.4.3	Setpoint Display /Setpoint Input	4.4.3
4.4.4	Rotation Setting	4.4.4
4.4.5	Start / Stop / Run	4.4.4
4.4.6	Leaving the Drive-Mode	4.4.5
4.4.7	Further Settings	4.4.5
5.	Parameter	5.1.3
5.1	Parameter	5.1.3
5.1.1	Parameter Groups	5.1.3
5.1.2	F5-BASIC Control	5.1.4
5.1.3	F5-GENERAL Control B-housing.....	5.1.4
5.1.4	F5-GENERAL Control >= D-housing	5.1.5
5.1.5	Parameter Listing	5.1.7
6.	Functional Description	6.1.3
6.1	Operating and Appliance Data	6.1.3
6.1.1	Overview of the ru-Parameters	6.1.3
6.1.2	Overview of the In-Parameters.....	6.1.4
6.1.3	Overview of the Sy-Parameters	6.1.4
6.1.4	Explanation to Parameter Description	6.1.5
6.1.5	Description of the ru-Parameters	6.1.6
6.1.6	Description of the In-Parameters	6.1.17
6.1.7	Description of the Sy-Parameters	6.1.21
6.2	Analog In- and Outputs	6.2.3
6.2.1	Summary Description Analog Inputs	6.2.3
6.2.2	Interface Selection (An.0; An.10)	6.2.4
6.2.3	Interference Suppression Filter (An.1; An.11; An.21)	6.2.5
6.2.4	Save Mode (An.2; An.12; An.22)	6.2.5
6.2.5	Input Selection (An.3; An.13; An.23)	6.2.5
6.2.6	Zero Point Hysteresis (An.4; An.14; An.24)	6.2.6
6.2.7	Amplifier of the Input Characterstic (An.5...7; An.15...17; An.25...27)	6.2.7
6.2.8	Lower and Upper Limit (An.8/9; An.18/19; An.28/29)	6.2.8

	6.2.9	Selection Set Point-/Auxiliary Input (An.30)	6.2.9
	6.2.10	Brief Description Analog Outputs	6.2.10
	6.2.11	Output signals	6.2.11
	6.2.12	Analog Output / Functions (An.31/An.36/An.41)	6.2.11
	6.2.13	Analog Output / Display	6.2.12
	6.2.14	Gain of Output Characteristic (An.33...35 /An.38...40 / An.43...45)	6.2.12
	6.2.15	Period ANOUT3 (An.46)	6.2.13
	6.2.16	ANOUT 1...4 Digital Settings (An.32/37/42/48)	6.2.13
	6.2.17	Used Parameters	6.2.14
6.3		Digital In- and Outputs	6.3.3
	6.3.1	Summary Description Digital Inputs	6.3.3
	6.3.2	Input Signals PNP / NPN (di.0)	6.3.3
	6.3.3	Setting of Digital Inputs by Software (di.1, di.2)	6.3.4
	6.3.4	Terminal Status (ru.21)	6.3.5
	6.3.5	Digital Filter (di.3)	6.3.5
	6.3.6	Inversion of Inputs (di.4)	6.3.5
	6.3.7	Edge-triggering (di.5)	6.3.5
	6.3.8	Strobe-dependent Inputs (di.6, di.7, di.8)	6.3.6
	6.3.9	Input Status (ru.22)	6.3.8
	6.3.10	Reset/Input Selection and Edge Evaluation (di.9 / di.10)	6.3.8
	6.3.11	Assignment of the Inputs	6.3.8
	6.3.12	Summary Description - Digital Outputs	6.3.11
	6.3.13	Output Signals	6.3.12
	6.3.14	Output filter (do.43, do.44)	6.3.12
	6.3.15	Switching Conditions (do.0...do.7)	6.3.13
	6.3.16	Inverting of Switching Conditions for Flags (do.8...do.15) ..	6.3.16
	6.3.17	Selection of Switching Conditions for Flags (do.16...do.23)	6.3.16
	6.3.18	Linking the Switching Conditions for Flags (do.24)	6.3.16
	6.3.19	Inverting of Flags (do.25...do.32)	6.3.17
	6.3.20	Selection of Flags (do.33...do.40)	6.3.17
	6.3.21	Linking the Flags (do.41)	6.3.17
	6.3.22	Inversion of Outputs (do.42)	6.3.18
	6.3.23	Output Terminal Status (ru.25)	6.3.18
	6.3.24	Programming Example	6.3.19
	6.3.25	Used Parameters	6.3.20
6.4		Setpoint-, Rotation- and Ramp Adjustment	6.4.3
	6.4.1	Summary Description	6.4.3
	6.4.2	Setpoint Selection oP.0	6.4.4
	6.4.3	Rotation Selection oP.1	6.4.6
	6.4.4	Fixed Frequencies (oP.18...23)	6.4.9
	6.4.5	Setpoint Limits	6.4.11
	6.4.6	Setpoint Computation	6.4.12
	6.4.7	Ramp Generator	6.4.13

	6.4.8	Limitier (oP.36...41)	6.4.15
	6.4.9	Ramp with constant time	6.4.15
	6.4.10	Used Parameters	6.4.18
6.5		Voltage-/Frequency Characteristic Adjustment	6.5.3
	6.5.1	Control Type (ud.2) and Max Frequency Mode (only F5-B)..	6.5.3
	6.5.2	Rated frequency (uF.0) and Boost (uF.1)	6.5.4
	6.5.3	Additional Rated Point (uF.2/uF.3)	6.5.4
	6.5.4	Delta Boost (uF.4/uF.5)	6.5.4
	6.5.5	Voltage Stabilization (uF.9).....	6.5.5
	6.5.6	Maximal voltage mode (uF.10).....	6.5.6
	6.5.7	Switching Frequency (uF.11)	6.5.6
	6.5.8	Used Parameters	6.5.7
6.6		Motor Data Adjustment	6.6.3
	6.6.1	Motor Name Plate	6.6.3
	6.6.2	Motor Data from the Name Plate (dr.0...dr.5)	6.6.3
	6.6.3	Motor Data from Data Sheets (dr. 9)	6.6.4
	6.6.4	Motor Stator Resistance (dr.6)	6.6.4
	6.6.5	Used Parameters	6.6.6
6.7		Protective Functions	6.7.3
	6.7.1	Ramp Stop and Hardware Current Limit.....	6.7.3
	6.7.2	Current Limit Constant Run (Stall-Function)	6.7.5
	6.7.3	Automatic Restart and Speed Search	6.7.7
	6.7.4	Dead Time Compensation uF.18	6.7.9
	6.7.5	Base-Block Time (uF.12) and Voltage Level (uF.13)	6.7.9
	6.7.6	Response to Errors or Warning Signal	6.7.9
	6.7.7	Quick Stop (Pn.58...60)	6.7.13
	6.7.8	Motor Protection Mode	6.7.15
	6.7.9	GTR7-Control	6.7.19
	6.7.10	Special Functions.....	6.7.20
6.8		Parameter Sets	6.8.3
	6.8.1	Not Programmable Parameters	6.8.3
	6.8.2	Security-Parameters	6.8.3
	6.8.3	System-Parameters	6.8.3
	6.8.4	Indirect and Direct Set Addressing	6.8.3
	6.8.5	Copying of Parameter Sets via Keyboard (Fr.1)	6.8.4
	6.8.6	Copying of Parameter Sets via Bus (Fr.1, Fr.9)	6.8.4
	6.8.7	Parameter Set Selection	6.8.5
	6.8.8	Locking of Parameter Sets.....	6.8.8
	6.8.9	Parameter Set ON/Off Delay (Fr.5, Fr.6)	6.8.8
	6.8.10	Used Parameters	6.8.9
6.9		Special Functions	6.9.3
	6.9.1	DC-Braking	6.9.3
	6.9.2	Energy Saving Function	6.9.5
	6.9.3	Motor Potentiometer Function	6.9.7
	6.9.4	Timer and Counter	6.9.11
	6.9.5	Brake Control	6.9.15

- 6.9.6 Power-Off Function 6.9.19
- 6.9.7 Wobbel Function 6.9.27
- 6.9.8 Diameter Correction 6.9.29
- 6.9.9 Positioning Function 6.9.31
- 6.9.10 Analog setting of parameter values 6.9.34
- 6.10 Encoder Interface 6.10.3**
 - 6.10.1 Designs 6.10.3
 - 6.10.2 Encoder Interface Channel 1 (X3A) 6.10.4
 - 6.10.3 Encoder Interface Channel 2 (X3B) 6.10.5
 - 6.10.4 Power Supply of Encoder 6.10.7
 - 6.10.5 Selection of Encoder 6.10.8
 - 6.10.6 Basic Setting 6.10.10
 - 6.10.7 Additional Parameters 6.10.13
 - 6.10.8 Used Parameters 6.10.14
- 6.11 SSM 6.11.3**
 - 6.11.1 Torque Compensation 6.11.3
 - 6.11.2 Speed Control 6.11.4
 - 6.11.3 Used Parameters 6.11.6
- 6.12 Technology Controller 6.12.3**
 - 6.12.1 The PID Controller 6.12.3
 - 6.12.2 PID Setpoint Value 6.12.5
 - 6.12.3 PID Actual Value 6.12.6
 - 6.12.4 Sample Applications 6.12.7
 - 6.12.5 Used Parameters 6.12.10
- 6.13 CP-Parameter Definition 6.13.3**
 - 6.13.1 Survey 6.13.3
 - 6.13.2 Assignment of CP-Parameters 6.13.4
 - 6.13.3 Example 6.13.5
 - 6.13.4 Display Standardization 6.13.6
 - 6.13.5 Used Parameters 6.13.8
- 7. Start-up 7.1.3**
 - 7.1 Preparatory Measures 7.1.3**
 - 7.1.1 After unpacking the Goods 7.1.3
 - 7.1.2 Installation and Connection 7.1.3
 - 7.1.3 Checklist prior to Start-up 7.1.4
- 8. Special Operations 8.1.2**
- 9. Error Assistance 9.1.3**
 - 9.1 Troubleshooting 9.1.3**
 - 9.1.1 General 9.1.3
 - 9.1.2 Error Messages and their Cause 9.1.3
- 10. Project Planning 10.1.3**
 - 10.1 General Design 10.1.3**
 - 10.1.1 Control Cabinet Design Calculation 10.1.3
 - 10.1.2 Design of Braking Resistors 10.1.4
 - 10.1.3 Cable and Fuses 10.1.6

11.	Networks	11.1.3
11.1	Network Components	11.1.3
11.1.1	Available Hardware	11.1.3
11.1.2	RS232-Cable PC /Operator 00.58.025-001D	11.1.3
11.1.3	HSP5-Cable PC / Control Board 00.F5.0C0-0001	11.1.3
11.1.4	Interface-Operator 00.F5.060-2000	11.1.4
11.1.5	Profibus-DP-Operator 00.F5.060-3000	11.1.5
11.1.6	InterBus Operator 00.F5.060-4000	11.1.6
11.1.7	CanOpen Operator 00.F5.060-5000	11.1.7
11.1.8	Sercos Operator 00.F5.060-6000	11.1.8
11.2.	Bus Parameters	11.2.3
11.2.1	Adjustment of Inverter Address (Sy.6)	11.2.3
11.2.2	Baud Rate ext. Bus (Sy.7)	11.2.3
11.2.3	Baud Rate int. Bus (Sy.11)	11.2.3
11.2.4	Watchdog-Time (Pn.6)	11.2.3
11.2.5	Response to E.bus (Pn.5)	11.2.3
11.2.6	HSP5 Watchdog Time (sY.9)	11.2.3
11.2.7	Control and Status Word	11.2.4
11.2.8	Speed Setting via Bus	11.2.5
11.2.9	Used Parameters	11.2.6
12.	Annex	12.1.3
12.1	Search and Find	12.1.3
12.1.1	Index	12.1.3
12.1.2	KEB- Worldwide	12.1.7
12.1.3	Domestic Representations	12.1.9

1.1.2 Preface

Who shall read all this?

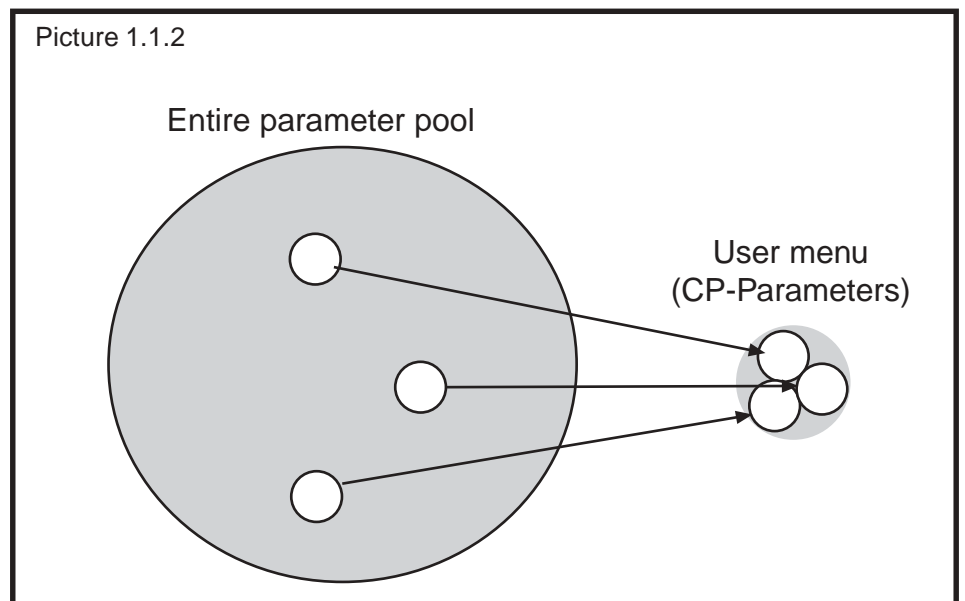
Everybody who is entrusted with the development and construction of applications. He who knows the extensive programming possibilities of the KEB COMBIVERT, can save external controls and expensive cabling already in the planning stage of a machine simply by using the unit as active control element. This manual is **not** a replacement of the documentation accompanying the unit, it serves only as completion.

1000 and one application...

and if possible with one unit. Who does not know this demand from purchasing departments, production or service. We have taken this request very seriously and developed a series with open programming, which can be adapted to the different applications with PC or operator.

Nobody can handle this...

some sceptics may say. But we have found a solution to this too. Once the development stage of a machine is completed only a few adjustment possibilities are needed on the inverter and in some cases even none at all. So why should all parameters still be visible? Said and done, by defining an own menu only selected parameters are visible. This makes the handling much easier, simplifies the user documentation and improves the safety of operation against unauthorized access (see picture 1.1.2).



Chapter	Section	Page	Date	Name:Basis	©	KEB Antriebstechnik, 2002 All Rights reserved
1	1	14	28.02.02	KEB COMBIVERT F5-G / B		

1.1.3 Record of Changes

No.	Typ ¹⁾	Date	Name	Description

* Typ: (B)ase; (N)ew; Chang(e); (A)ddition

Chapter	Section	Page	Date	Name:Basis	©	KEB Antriebstechnik, 2002 All Rights reserved
1	1	16	28.02.02	KEB COMBIVERT F5-G / B		

- 1. Introduction
- 2. Summary**
- 3. Hardware
- 4. Operation
- 5. Parameter
- 6. Functions
- 7. Start-up
- 8. Special Operation
- 9. Error Assistance
- 10. Project Planning
- 11. Networks
- 12. Annex

2.1 Product Description

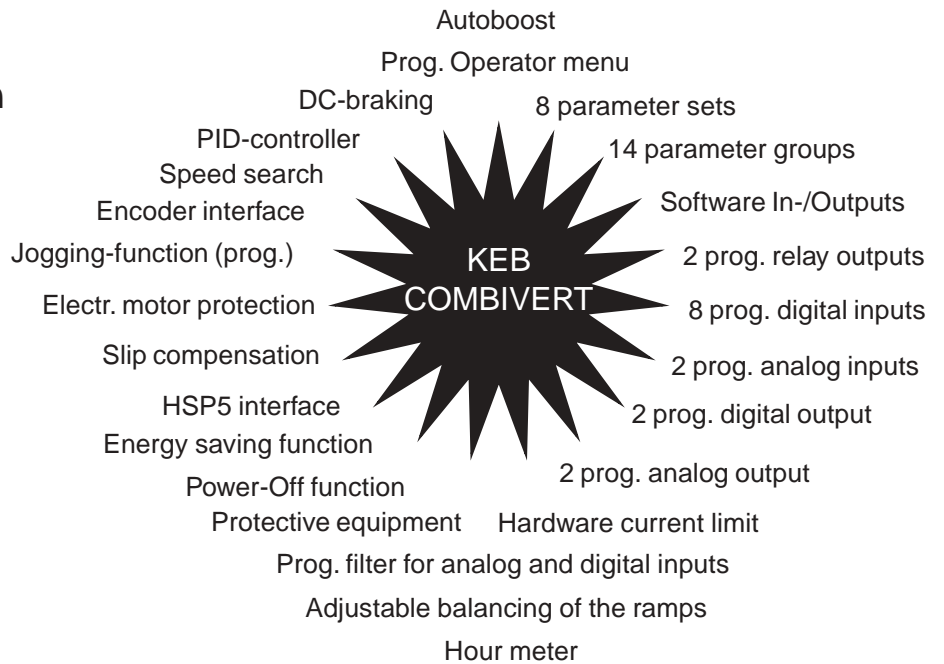
- 2.1.1 Features of KEB COMBIVERT 3
- 2.1.2 Function Principle 3
- 2.1.3 Application as directed 4
- 2.1.4 Type Code 5
- 2.1.5 Validity of Specifications 6
- 2.1.6 Unit Sizes 230V-Class 6
- 2.1.7 Unit Sizes 400V-Class 7
- 2.1.8 Overload curve 12
- 2.1.9 Overload protection in the lower speed range 12

Chapter	Section	Page	Date	Name: Basis	©	KEB Antriebstechnik, 2002 All Rights reserved
2	1	2	10.04.02	KEB COMBIVERT F5		

2. Overview

2.1 Product Description

2.1.1 Features of KEB COMBIVERT



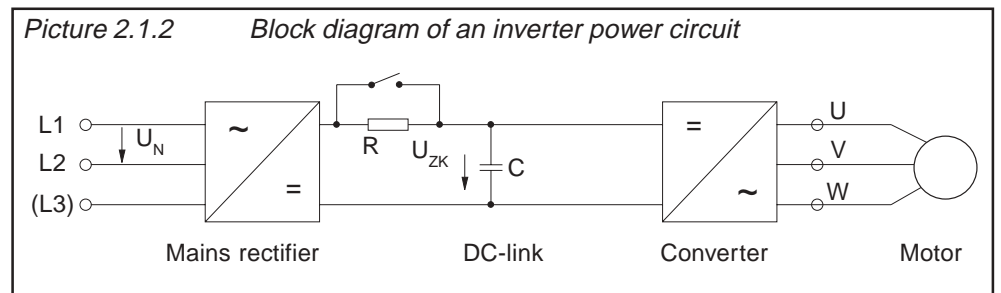
2.1.2 Function Principle

The power circuit of a frequency inverter consists basically of a mains rectifier, the DC-link and an inverter at the output. The mains rectifier consists of an uncontrolled single or three-phase bridge connection, the single-phase design is restricted to small powers. It converts the AC-voltage of the mains into a DC-voltage, which is smoothed by the DC-link capacitor, thus in the ideal case (inverter unloaded) the DC-link is charged with a voltage of $U_{zK} = \sqrt{2} \cdot U_N$.

Since during the charging of the DC-link capacitor very high currents flow for a short time which would lead to the tripping of the input fuses or even to the destruction of the mains rectifier, the charging current must be limited to a permissible level. This is achieved by using an inrush current limiting resistor in series to the capacitor. After the charging of the capacitor is completed the limiting resistor is bridged, for example, by a relay and is therefore only active at the switch-on of the inverter.

As the smoothing of the DC-link voltage requires a large capacity, the capacitor still has a high voltage for some time after the disconnection of the inverter from the mains.

The actual task of the frequency inverter, to produce an output voltage variable in frequency and amplitude for the control of the three-phase AC motor, is taken over by the converter at the output. It makes available a 3-phase output voltage according to the principle of the pulse-width modulation, which generates a sinusoidal current at the three-phase asynchronous motor



2.1.3 Application as directed



The KEB COMBIVERT is a frequency inverter with DC-voltage link. It works according to the principle of the pulse-width modulation and serves exclusively for the stepless speed control of three-phase AC motors.

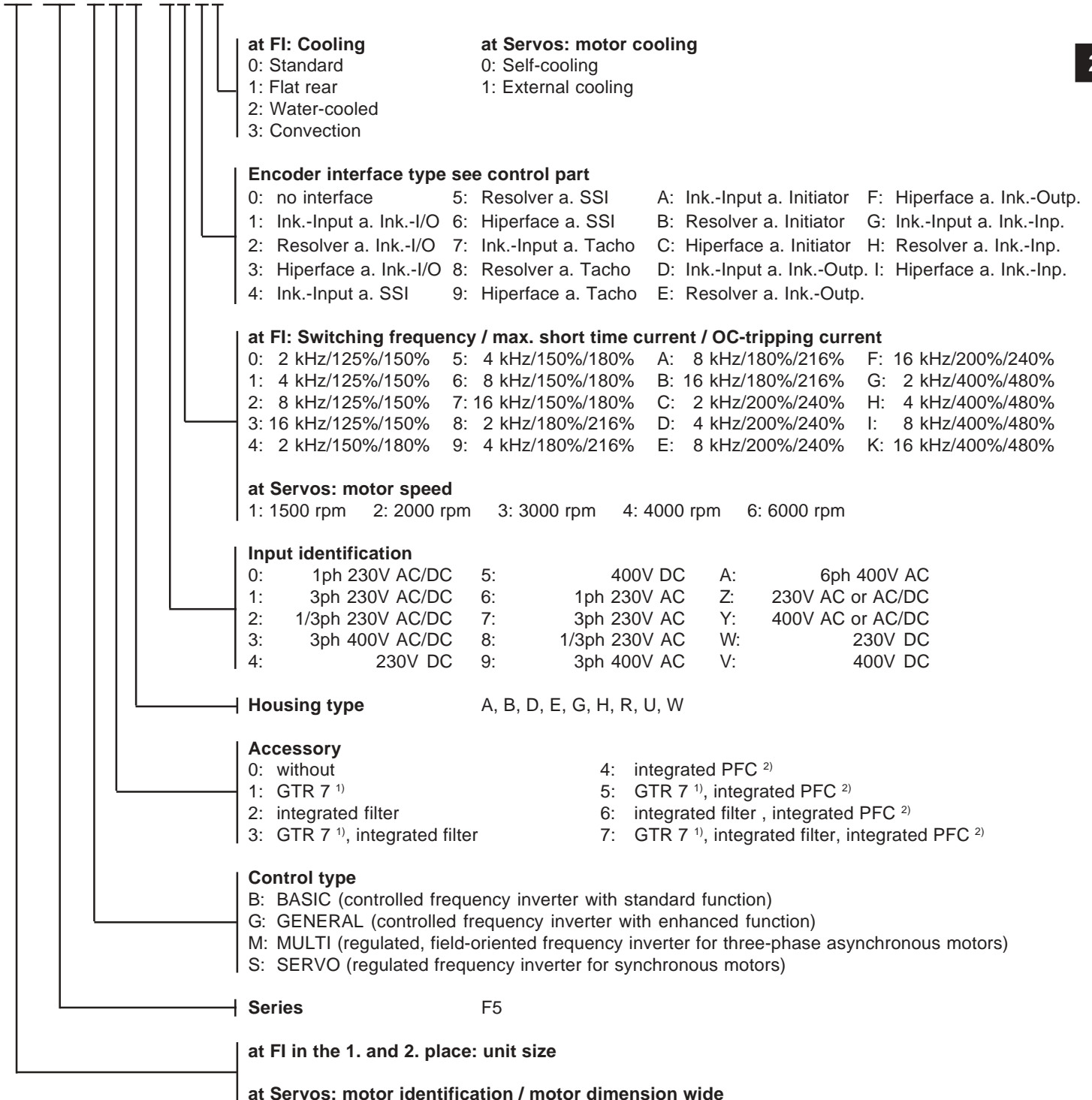
The unit has been developed subject to the relevant safety standards and is manufactured with the highest demands on quality. Condition for an unobjectionable operation is the function-conform configuring of the drive and correct transport and storage as well as careful installation and connection.



The operation of other electric consumers is prohibited and can lead to the destruction of the units as well as consequential damages as a result from it.

2.1.4 Type Code

10.F5.G1B-3200



1) GTR 7: brake transistor
 2) PFC: Power Factor Control

2.1.5 Validity of Specifications

The following technical specifications refer to 2-/4-pole standard motors. In case of different pole numbers the frequency inverter must be dimensioned for the rated motor current. With regard to special or medium frequency motors, please contact KEB.

The power losses always refer to the max. switching frequency. If the switching frequency is reduced, the power loss is reduced as well.

Site altitude max. 2000 m. For altitudes of 1000 m or more above N.N. a power reduction of 1 % per 100m must be taken into account.

2.1.6 Unit Sizes 230V-Class

Inverter Size	05			07			09				10				12	13	14
	A	B		A	B		B		D		B		D		D	E	E
Housing size	1	1	3	1	1	3	1	3	1	3	1	3	1	3	3	3	3
Phases	1	1	3	1	1	3	1	3	1	3	1	3	1	3	3	3	3
Output rated power [kVA]	0,9			1,6			2,8				4,0				6,6	9,5	13
Max. rated motor power [kW]	0,37			0,75			1,5				2,2				4,0	5,5	7,5
Output rated current [A]	2,3			4			7				10				16,5	24	33
Max. short time current ¹⁾ [A]	4,1			7,2			12,6				18				29,7	36	49,5
OC-tripping current [A]	5,0			8,6			15,1				21,6				35,6	43	59
Input rated current [A]	4,6	4,6	3,2	8,0	8,0	5,6	14	9,8	14	9,8	20	14	20	14	23	31	43
Input rated current ²⁾ [A]	–	3,7	–	–	6,4	–	–				–				–	–	–
Real input rated power ²⁾ [kW]	–	0,85	–	–	1,5	–	–				–				–	–	–
Max. permissible mains fuse (inert) [A]	10	16		10	20	16	20	16	20	16	25	20	25	20	25	35	50
Rated operating frequency [kHz]	4	16		8	16		16				8	16		8	8	4	
Max. operating frequency [kHz]	8	16		8	16		16				16				16	16	16
Power loss at rated operation [W]	30	50		55	65		90	130		105	170		210	290	350		
Power loss at rated operation ²⁾ [W]	–	85	–	–	130	–	–				–				–	–	–
Stall current at 4kHz ³⁾ [A]	2,3			4			7				10				16,5	24	33
Stall current at 8kHz ³⁾ [A]	2,3			4			7				10				16,5	24	24
Stall current at 16kHz ³⁾ [A]	–	2,3		–	4		7				8,5	10		10	16,8	16,8	
Max. heat sink temperature TOH [°C]	90																
Motor line cross section ⁴⁾ [mm ²]	1,5	1,5	1,5	2,5	1,5	2,5	1,5	2,5	1,5	2,5	4	2,5	4	2,5	4	6	10
Min. braking resistor ⁵⁾ [Ohm]	100	56		100	56		47				33				27	16	16
Typ. braking resistor ⁵⁾ [Ohm]	180	100		100			68				56				47	22	22
Max. braking current [A]	4,5	7,5		4,5	7,5		9,5				12				15	25	25
Overload curve	1																
Tightening torque for terminal strip [Nm]	0,5															1,2	
Mains voltage [V]	180...260 ±0 (230 V rated voltage)																
Mains frequency [Hz]	50 / 60 +/- 2																
Output voltage [V]	3 x 0...U Mains (3 x 0...255V ²⁾)																
Output frequency [Hz]	see control board																
Max. shielded motor line length at 4 kHz ⁶⁾ [m]	10	30	10	100	100				100								
Max. shielded motor line length at 8 kHz ⁶⁾ [m]	10	20	10	50	100				100								
Max. shielded motor line length at 16kHz ⁶⁾ [m]	–	10	–	20	40				100								
Storage temperature [°C]	-25...70 °C																
Operating temperature [°C]	-10...45 °C																
Design / type of protection	IP20																
Relative humidity	max. 95% without condensation																
EMC tested according to product standard	EN 61800-3																
Climatic category	3K3 in accordance with EN 50178																

1) With the regulated systems F5-M as well as F5-S 5% are to be subtracted as control reserve

2) This data is only valid for units with integrated PFC (see "unit identification")

3) Max. current before the responding of the OL2-function (only F5-M; F5-S; F5-A)

4) Recommended minimum cross section for rated power and a cable length of upto 100m (copper)

5) This data is only valid for units with internal brake transistor GTR 7 (see "unit identification")

6) At units with integrated filter (see "unit identification"):

up to max. 5m line length and 4kHz operating frequency = Limit Value B (EN 55011)

up to max. 10m line length and 16kHz operating frequency = Limit Value A (EN 55022)

Chapter	Section	Page	Date	Name: Basis	©	KEB Antriebstechnik, 2002
2	1	6	10.04.02	KEB COMBIVERT F5		All Rights reserved

2.1.7 Unit Sizes 400V-Class

Inverter Size	05	07	09		10		12			13		14	
Housing size	B	B	B	D	B	D	B	D	E	D	E	E	G
Phases	3	3	3		3		3			3		3	
Output nominal power [kVA]	0,9	1,8	2,8		4,0		6,6			8,3		11	
Max. rated motor power [kW]	0,37	0,75	1,5		2,2		4,0			5,5		7,5	
Output nominal current [A]	1,3	2,6	4,1		5,8		9,5			12		16,5	
Max. short time current ¹⁾ [A]	2,3	4,7	7,4		10,4		17			21,6		29,7	24,8
OC-tripping current [A]	2,8	5,6	8,9		12,5		21			25,9		35,6	29,7
Nominal input current [A]	1,8	3,6	6		8		13			17		23	
Max. permissible mains fuse (inert) [A]	16	16	16		16		20			25		25	
Rated operating frequency [kHz]	16	16	8		8	16	4	8	16	4	16	8	16
Max. operating frequency [kHz]	16	16	16		16		4			16		16	
Power loss at nominal operating [W]	60	90	80	105	120	170	150	185	300	185	250	320	260
Stall current at 4kHz ²⁾ [A]	1,3	2,6	4,1		5,8		7,6			9,5		12	
Stall current at 8kHz ²⁾ [A]	1,3	2,6	4,1		5,8		-			9,5		12	
Stall current at 16kHz ²⁾ [A]	1,3	2,6	3,5		4,9	5,8	-			5,8	9,5	5,8	12
Max. heat sink temperature TOH [°C]	90												
Motor line cross section ³⁾ [mm ²]	1,5	1,5	1,5		1,5		2,5			4		4	
Min. braking resistor ⁴⁾ [Ohm]	390	120	120		82		82			56	39	39	
Typ. braking resistor ⁴⁾ [Ohm]	390	390	270		270		150			100		82	
Max. braking current [A]	2,2	7,5	7,5		10		10			15	21	21	
Overload curve	1												
Tightening torque for terminals [Nm]	0,5											0,5	1,2
Mains voltage ⁵⁾ [V]	305...500 ±0 (400 V Nominal voltage)												
Mains frequency [Hz]	50 / 60 +/- 2												
Output voltage [V]	3 x 0...U Mains												
Output frequency [Hz]	see Control board												
Max.shielded motor line length at 4 kHz [m]	10	10	100		100		50			100			
Max.shielded motor line length at 8 kHz [m]	8	8	30		50	100	-			100			
Max.shielded motor line length at 16 kHz [m]	4	5	10		10	20	-			100			
Storage temperature [°C]	-25...70 °C												
Operating temperature [°C]	-10...45 °C												
Model / protective system	IP20												
Relative humidity	max. 95% without condensation												
EMC tested according to product standard	EN 61800-3												
Climatic category	3K3 in accordance with EN 50178												

- 1) With the regulated systems F5-M as well as F5-S 5% are to be subtracted as control reserve.
- 2) Max. current before the responding of the OL2-function (only F5-M; F5-S; F5-A)
- 3) Recommended minimum cross section for rated power and a cable length of upto 100m (copper)
- 4) This data is only valid for units with internal brake transistor GTR 7 (see "unit identification")
- 5) At mains voltage ≥ 460V multiply the nominal current with factor 0,86.

Inverter Size	15			16		17		18		19	
Housing size	E	G	H	G	H	G	H	H	R	H	R
Phases	3			3		3		3		3	
Output nominal power [kVA]	17			23		29		35		42	
Max. rated motor power [kW]	11			15		18,5		22		30	
Output nominal current [A]	24			33		42		50		60	
Max. short time current ¹⁾ [A]	36			49,5		63		75		90	
OC-tripping current [A]	43			59		75		90		108	
Nominal input current [A]	31			43		55		65		66	
Max. permissible mains fuse (inert) [A]	35			50		63		80		80	
Rated operating frequency [kHz]	4	8	16	8	16	4	8	8	16	4	8
Max. operating frequency [kHz]	16			16		16		16		16	
Power loss at nominal operating [W]	350	290	360	310	490	360	470	610	850	540	750
Stall current at 4kHz ²⁾ [A]	24			33		42		50		60	
Stall current at 8kHz ²⁾ [A]	16	19	24	21,5	33	21,4	30	45	50	39	60
Stall current at 16kHz ²⁾ [A]	10	8,5	15	9,5	20	–	13,5	20	40	18	27
Max. heat sink temperature TOH [°C]	90										
Motor line cross section ³⁾ [mm ²]	6			10		16		25		25	
Min. braking resistor ⁴⁾ [Ohm]	39	39	22	25	22	25	22	13	9	13	9
Typ. braking resistor ⁴⁾ [Ohm]	56			39		28		22		16	
Max. braking current [A]	21	21	37	30	37	30	37	63	88	63	88
Overload curve	1										
Tightening torque for terminals [Nm]	1,2		2,5	1,2	2,5	1,2	2,5	6	2,5	6	
Mains voltage ⁵⁾ [V]	305...500 ±0 (400 V Nominal voltage)										
Mains frequency [Hz]	50 / 60 +/- 2										
Output voltage [V]	3 x 0...U Mains										
Output frequency [Hz]	see Control board										
Max. shielded motor line length [m]	100										
Storage temperature [°C]	-25...70 °C										
Operating temperature [°C]	-10...45 °C										
Model / protective system	IP20										
Relative humidity	max. 95% without condensation										
EMC tested according to product standard	EN 61800-3										
Climatic category	3K3 in accordance with EN 50178										

- 1) With the regulated systems F5-M as well as F5-S 5% are to be subtracted as control reserve.
- 2) Max. current before the responding of the OL2-function (only F5-M; F5-S; F5-A)
- 3) Recommended minimum cross section for rated power and a cable length of upto 100m (copper)
- 4) This data is only valid for units with internal brake transistor GTR 7 (see "unit identification")
- 5) At mains voltage ≥ 460V multiply the nominal current with factor 0,86.

Inverter Size	20	21		22		23		24	
Housing size	R	R	R	R	R	R	U	U	U
Phases	3	3		3		3		3	
Output nominal power [kVA]	52	62		80		104		125	
Max. rated motor power [kW]	37	45		55		75		90	
Output nominal current [A]	75	90		115		150		180	
Max. short time current ¹⁾ [A]	112	135		172		225		270	
OC-tripping current [A]	135	162		207		270		324	
Nominal input current [A]	83	100		127		165		198	
Max. permissible mains fuse (inert) [A]	100	160		160		200		315	
Rated operating frequency [kHz]	8	4	8	4	8	2	8	4	8
Max. operating frequency [kHz]	16	16	16	16	16	12	8	8	8
Power loss at nominal operating [W]	900	1000	1100	1200	1500	1300	1900	2000	2400
Stall current at 4kHz ²⁾ [A]	75	90		115		–	150	180	
Stall current at 8kHz ²⁾ [A]	75	63	90	80	115	–	150	117	180
Stall current at 16kHz ²⁾ [A]	34	45	54	46	51	–	–	–	–
Max. heat sink temperature TOH [°C]	90								
Motor line cross section ³⁾ [mm ²]	35	50		50		95		95	
Min. braking resistor ⁴⁾ [Ohm]	9	9		9		6	5	4	
Typ. braking resistor ⁴⁾ [Ohm]	13	11		9		6		6	
Max. braking current [A]	88	88		88		133	160	200	
Overload curve	1								
Tightening torque for terminals [Nm]	6					15			
Mains voltage ⁵⁾ [V]	305...500 ±0 (400 V Nominal voltage)								
Mains frequency [Hz]	50 / 60 +/- 2								
Output voltage [V]	3 x 0...U Mains								
Output frequency [Hz]	see Control board								
Max. shielded motor line length [m]	50								
Storage temperature [°C]	-25...70 °C								
Operating temperature [°C]	-10...45 °C								
Model / protective system	IP20								
Relative humidity	max. 95% without condensation								
EMC tested according to product standard	EN 61800-3								
Climatic category	3K3 in accordance with EN 50178								

- 1) With the regulated systems F5-M as well as F5-S 5% are to be subtracted as control reserve.
- 2) Max. current before the responding of the OL2-function (only F5-M; F5-S; F5-A)
- 3) Recommended minimum cross section for rated power and a cable length of upto 100m (copper)
- 4) This data is only valid for units with internal brake transistor GTR 7 (see "unit identification")
- 5) At mains voltage ≥ 460V multiply the nominal current with factor 0,86.

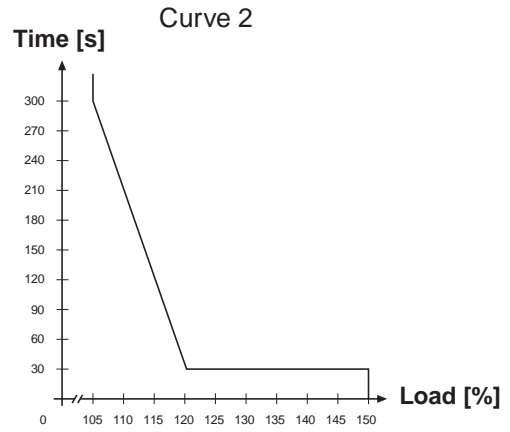
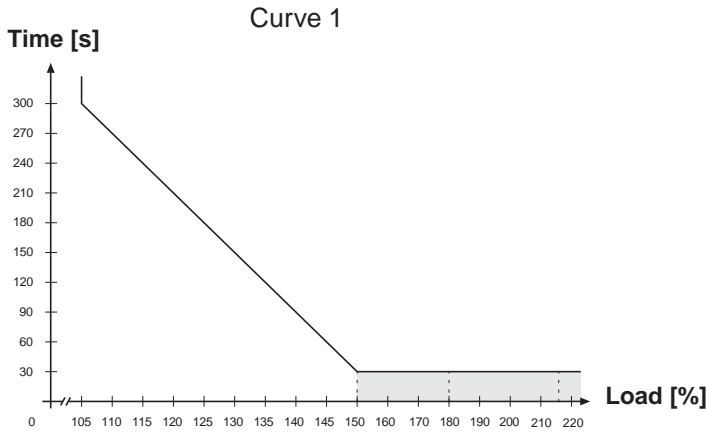
Inverter Size	25	26	27
Housing size	U	U	U
Phases	3	3	3
Output nominal power [kVA]	145	173	208
Max. rated motor power [kW]	110	132	160
Output nominal current [A]	210	250	300
Max. short time current ¹⁾ [A]	263	313	375
OC-tripping current [A]	315	375	450
Nominal input current [A]	231	275	330
Max. permissible mains fuse (inert) [A]	315	400	450
Rated operating frequency [kHz]	4	4	2
Max. operating frequency [kHz]	8	8	8
Power loss at nominal operating [W]	2300	2800	3100
Stall current at 4kHz ²⁾ [A]	210	250	240
Max. heat sink temperature TOH [°C]	90		
Motor line cross section ³⁾ [mm ²]	95	120	150
Min. braking resistor ⁴⁾ [Ohm]	4		
Typ. braking resistor ⁴⁾ [Ohm]	4		
Max. braking current [A]	200		
Overload curve	2		
Tightening torque for terminals [Nm]	25		
Mains voltage ⁵⁾ [V]	305...500 ±0 (400 V Nominal voltage)		
Mains frequency [Hz]	50 / 60 +/- 2		
Output voltage [V]	3 x 0...U Mains		
Output frequency [Hz]	see Control board		
Max. shielded motor line length [m]	50		
Storage temperature [°C]	-25...70 °C		
Operating temperature [°C]	-10...45 °C		
Model / protective system	IP20		
Relative humidity	max. 95% without condensation		
EMC tested according to product standard	EN 61800-3		
Climatic category	3K3 in accordance with EN 50178		

- 1) With the regulated systems F5-M as well as F5-S 5% are to be subtracted as control reserve.
- 2) Max. current before the responding of the OL2-function (only F5-M; F5-S; F5-A)
- 3) Recommended minimum cross section for rated power and a cable length of upto 100m (copper)
- 4) This data is only valid for units with internal brake transistor GTR 7 (see "unit identification")
- 5) At mains voltage ≥ 460V multiply the nominal current with factor 0,86.

Inverter Size	28		29		30	31
Housing Size	W					
Phases	3	2 x 3	3	2 x 3	2 x 3	2 x 3
Output nominal power [kVA]	256		319		395	436
Max. rated motor power [kW]	200		250		315	355
Output nominal current [A]	370		460		570	630
Max. short time current ¹⁾ [A]	463		575		713	787
OC-tripping current [A]	555		690		855	945
Nominal input current [A]	410	2x205	510	2x255	2x315	2x350
Max. permissible mains fuse (inert) ²⁾ [A]	550	315	700	400	450	550
Rated operating frequency [kHz]	2		2		2	2
Max. operating frequency [kHz]	4		2		2	2
Power loss at nominal operating [W]	3500		4200		5100	5600
Stall current at 4kHz ³⁾ [A]	370		–		–	
Max. heat sink temperature TOH [°C]	90		90		90	60
Motor line cross section ⁴⁾ [mm ²]	2x95		2x150		2x185	2x185
Min. braking resistor ⁵⁾ [Ohm]	1,2		1,2		1,2	1,2
Typ. braking resistor ⁵⁾ [Ohm]	2,2		1,7		1,3	–
Max. braking current [A]	660		660		660	660
Overload curve	2					
Tightening torque for terminals [Nm]	25...30					
Mains voltage ⁶⁾ [V]	305...500 ±0					
Mains frequency [Hz]	50 / 60 +/- 2					
Output voltage [V]	3 x 0...U mains					
Output frequency [Hz]	see control card					
Max. shielded motor line length [m]	50					
Storage temperature [°C]	-25...70 °C					
Operating temperature [°C]	-10...45 °C				-10...45 °C ⁷⁾	
Model / protective system	IP20					
Relative humidity	max. 95% without condensation					
EMC tested in accordance with ...	EN 61800-3					
Climatic category	3K3 according EN 50178					

- 1) With the regulated systems F5-M as well as F5-S 5% are to be subtracted as control reserve.
- 2) Fuses of type Ferraz Shawmut 6,6 UD Type 31
- 3) Max. current before the responding of the OL2-function (only F5-M; F5-S; F5-A)
- 4) Recommended minimum cross section for rated power and a cable length of upto 100m (copper)
- 5) This data is only valid for units with internal brake transistor (see "unit identification")
- 6) Rated voltage 400V; at mains voltage ≥ 460V multiply the rated current with factor 0.86.
- 7) The temperature range is only valid for the control circuit. For the power circuit the temperature range is depending on the control cabinet installation and the cooling system.

2.1.8 Overload curve

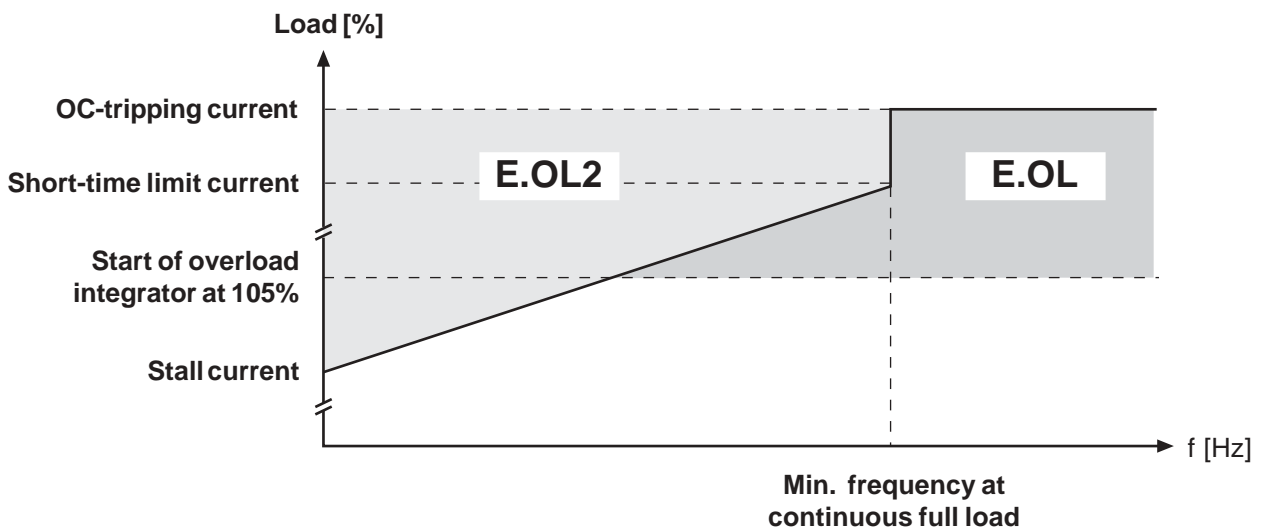


The characteristic declines device-dependently in this range (see technical data)

On exceeding a load of 105 % the counter starts. When falling below the counter counts backwards. If the counter achieves the overload characteristic that corresponds to the inverter the error E.OL is triggered.

2.1.9 Overload protection in the lower speed range

(only valid for F5-M and F5-S, stall current see technical data)



If the permissible current is exceeded a PT1-element ($\tau=280\text{ms}$) starts, after its sequence of operation the error E.OL2 is triggered.

1. Introduction

2. Summary

3. Hardware

4. Operation

5. Parameter

6. Functions

7. Start-up

8. Special Operation

9. Error Assistance

10. Project Planning

11. Networks

12. Annex

3.1 Control Units

3.1.1	Survey	3
3.1.2	Terminal strip X2A	4
3.1.3	Connection of the control	5
3.1.4	Digital inputs	5
3.1.5	Analog inputs	6
3.1.6	Voltage input / external power supply	7
3.1.7	Digital outputs	7
3.1.8	Relay outputs	7
3.1.9	Analog outputs	8
3.1.10	Voltage output	8

Chapter 3	Section 1	Page 2	Date 04.12.01	Name: Basis KEB COMBIVERT F5-G / B	© KEB Antriebstechnik, 2001 All Rights reserved
---------------------	---------------------	------------------	------------------	--	--

3. Hardware

3.1 Control Units

In this application manual the control cards F5-BASIC and F5-GENERAL are described. The control card F5-GENERAL is available in two version, one version for housing size B and another version for larger housings. The control cards F5-BASIC and F5-GENERAK in the B-housing have a restricted functional range compared to the large F5-GENERAL control card. These restrictions generally refer to the missing hardware components and the appropriate parameters.

3.1.1 Survey

The following section is to get an overview of the F5 control cards.

Contol card	BASIC	GENERAL B	GENERAL >=D
Inputs			
Set value input	1	2	2 (optionally +1)
Digital inputs (programmable)	5	8	8
Internal inputs	4	4	4
External supply of the control card	-	X	X
Encoder interface	-	-	X (optionally)
Scan time of the in- and outputs	2 ms	1 ms	1 ms
Outputs			
Analog outputs ± 10 V	1	1	2
Digital outputs	-	2	2
Relay outputs	2	2	2
Internal outputs	4	4	4
Potential-free operator output	X	X	X
Functions			
Parameter sets	8	8	8
Aux function	X	X	X
Brake control	X	X	X
DC braking	X	X	X
Energy saving function	X	X	X
Speed search	X	X	X
Autoboost	X	X	X
Slip compensation	X	X	X
Fixed frequencies	X	X	X
Electronic motor protection	X	X	X
Power on counter	X	X	X
Power off function	X	X	X
PID controller	X	X	X
Jerk lever starting by s-curves	X	X	X
Bus response time	2 ms	1 ms	1 ms
Suitable for			
Housing size A	X	-	-
Housing size B	X	X	-
Housing size D	X	-	X
Housing size E	X	-	X
Housing size >= G	X	-	X

3.1.2 Terminal strip X2A

BASIC



GENERAL



PIN	Function	Name	Description
1	+ Set Value input 1	AN1+	The input signal (0...±10 V; 0...±20 mA and 4...20 mA) is determined with An.0/10. Specification and control see chap. 6.2.2. Resolution: 12 Bit (BASIC and GENERAL B-housing: 11 Bit) Scan time: 1 ms (BASIC: 2 ms) at directly setpoint input: 250 µs (see chapter 6.4.2)
2	- Set Value input 1	AN1-	
3	+ Set Value input 2	AN2+	
4	- Set Value input 2	AN2-	
5	Analog Output 1	ANOUT1	The variable for outputting at analog output 2 is determined with An.31 / 36. Specification and control see chap. 6.2.11. Voltage range: 0...±10V, Ri = 100 Ω, Resolution: ±10 Bit
6	Analog Output 2	ANOUT2	
7	+10 V Output	CRF	Reference voltage output +10 VDC +5% / max. 4 mA for set value potentiometer.
8	Analog Mass	COM	Mass for analog in- and outputs
9	Analog Mass	COM	Mass for analog in- and outputs
10	Progr. Input 1	I1	Specifications, control and programming of the digital inputs see chap. 6.3.1...6.3.11 All digital inputs are free programmable. The control release is firmly linked with the input ST, but can be additional occupied with other functions. Ri = 2,1 kΩ Scan time: 1 ms (BASIC: 2 ms)
11	Progr. Input 2	I2	
12	Progr. Input 3	I3	
13	Progr. Input 4	I4	
14	Progr. Input Forward	F	
15	Progr. Input Reverse	R	
16	Progr. Input Control Rel.	ST	
17	Progr. Input Reset	RST	
18	Transistor Output 1	O1	Specifications, control and programming of the digital transistor outputs see chap. 6.3.12...6.3.22, a total of max. 50 mADC for both outputs
19	Transistor Output 2	O2	
20	+24 V Output	U _{out}	approx. 24V DC output (max. 100 mA) Ext. supply voltage for digital in-/outputs, potential 0V (X2A.22/23)
21	20...30 V Input	U _{in}	
22	Digital Mass	0V	Potential for digital in-/outputs
23	Digital Mass	0V	Potential for digital in-/outputs
24	Relay 1 /NO contact	RLA	Specifications, control and programming of the relay outputs see chapter 6.3.11...6.3.17 max. 30 V DC, 1 A
25	Relay 1 /NC contact	RLB	
26	Relay 1 /switching contact	RLC	
27	Relay 2 /NO contact	FLA	
28	Relay 2 /NC contact	FLB	
29	Relay 2 /switching contact	FLC	

3.1.3 Connection of the control

In order to prevent a malfunction caused by interference voltage supply on the control inputs, the following directions should be observed:

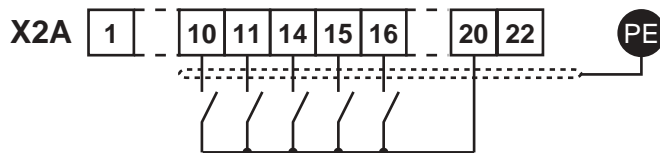


- Use shielded/drilled cables
- Lay shield **on one side** of the inverter onto earth potential
- Lay control and power cable **separately** (about 10...20 cm apart)
- Lay crossings in a right angle (in case it cannot be prevented)

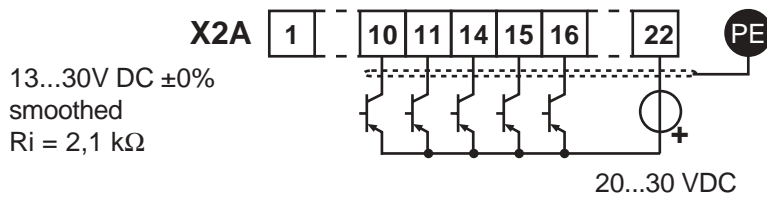
3.1.4 Digital inputs

Control card BASIC:

Use of **internal** voltage supply

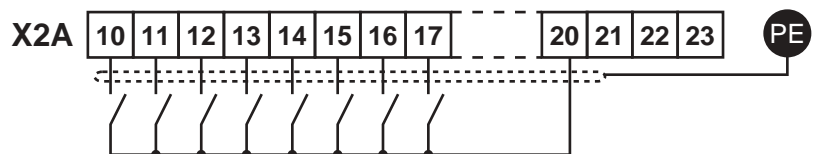


Use of **external** voltage supply

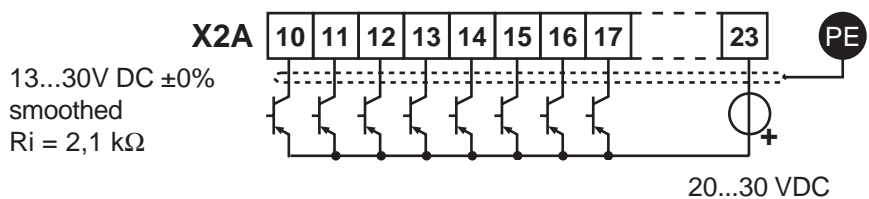


Control card GENERAL:

Use of **internal** voltage supply

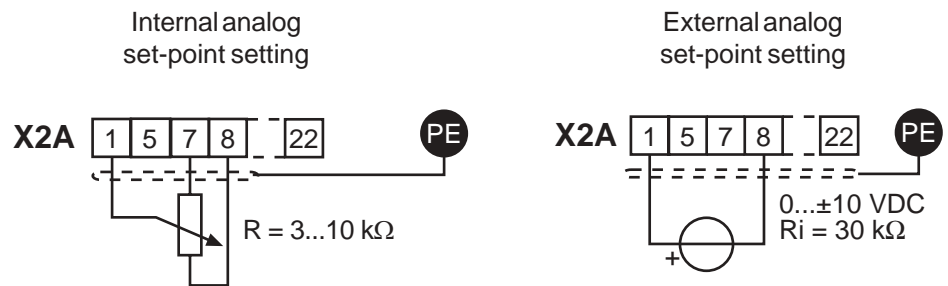


Use of **external** voltage supply



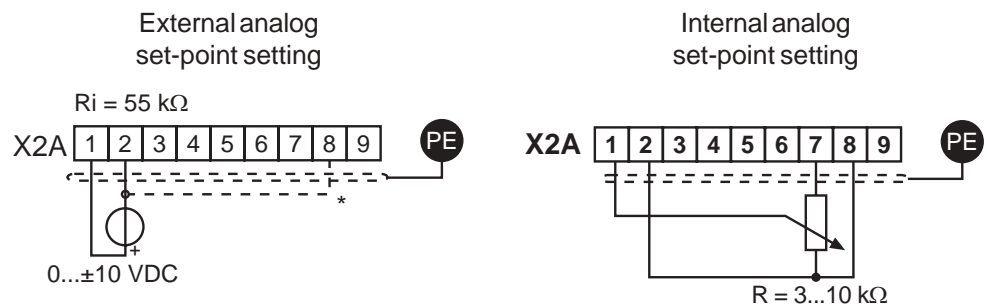
3.1.5 Analog inputs

Control card BASIC:



Control card GENERAL:

Connect unused analog inputs to common, to prevent set value fluctuations!

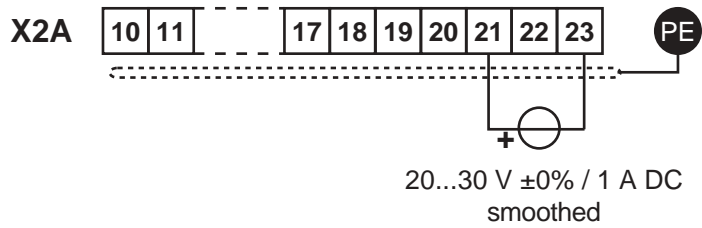


*) Connect potential equalizing line only if a potential difference of > 30 V exists between the controls.

3.1.6 Voltage Input / External Power Supply

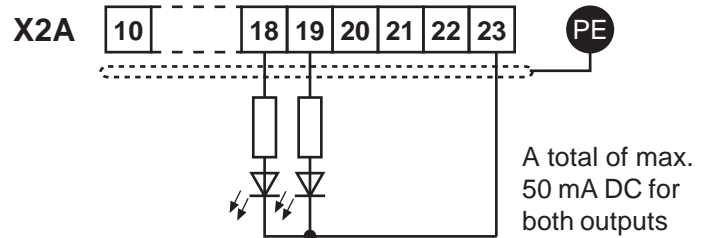
The supply of the control circuit through an external voltage source keeps the control in operational condition even if the power stage is switched off. To prevent undefined conditions at external power supply the basic procedure is to first switch on the power supply and after that the inverter.

Control card GENERAL:



3.1.7 Digital Outputs

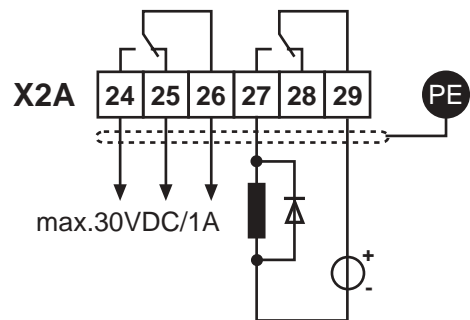
Control card GENERAL:



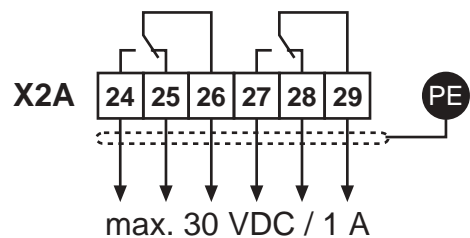
3.1.8 Relay Outputs

In case of inductive load on the relay outputs a protective wiring must be provided (e.g. free-wheeling diode)!

Control card BASIC:

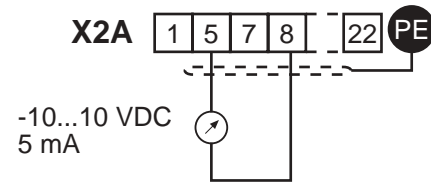


Control card GENERAL:

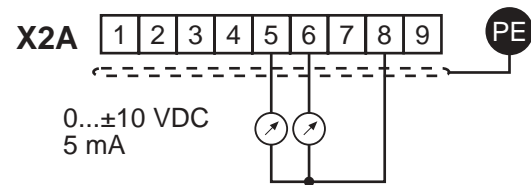


3.1.9 Analog Outputs

Control card BASIC:



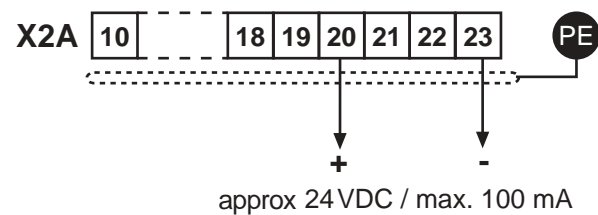
Control card GENERAL:



3.1.10 Voltage Output

The voltage output serves for the setting of the digital inputs as well as for the supply of external control elements. Do not exceed the maximum output current of 100 mA.

Control card GENERAL:



- 1. Introduction
- 2. Summary
- 3. Hardware
- 4. Operation**
- 5. Parameter
- 6. Functions
- 7. Start-up
- 8. Special Operation
- 9. Error Assistance
- 10. Project Planning
- 11. Networks
- 12. Annex

- 4.1 Fundamentals**
- 4.2 Password Structure
- 4.3 CP-Parameter
- 4.4 Drive-Mode

- 4.1.1 Parameters, Parameter Groups, Parameter Sets 3
- 4.1.2 Selection of a Parameter 4
- 4.1.3 Adjustment of Parameter Values 4
- 4.1.4 ENTER-Parameter 4
- 4.1.5 Non-programmable Parameters 5
- 4.1.6 Resetting of Error Messages . 5
- 4.1.7 Resetting of Peak Values 5
- 4.1.8 Acknowledgement of Status Signals 5

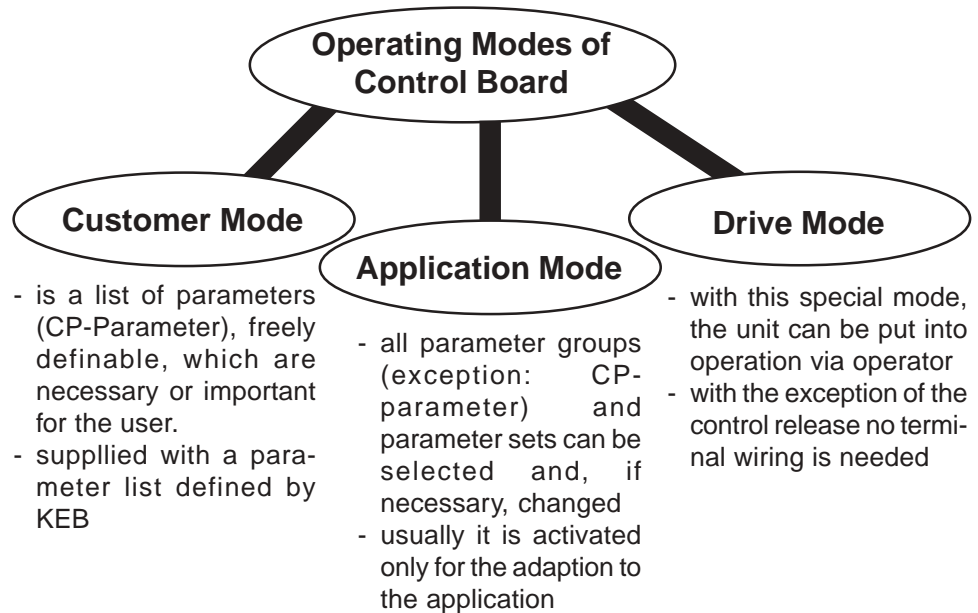
Chapter 4	Section 1	Page 2	Date 10.04.02	Name: Basis KEB COMBIVERT F5	© KEB Antriebstechnik, 2002 All Rights reserved
---------------------	---------------------	------------------	------------------	--	--

4. Operation

4.1 Fundamentals

The following chapter describes the fundamentals of the software structure as well as the operation of the unit.

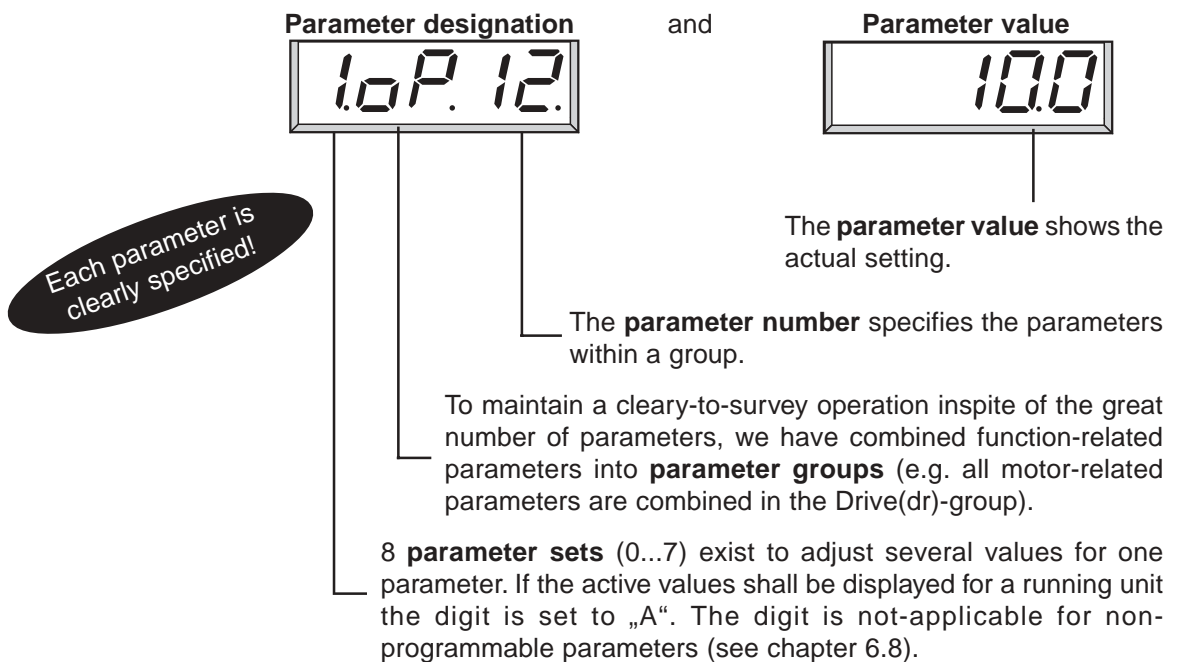
The control boards F5-BASIC and F5-GENERAL incorporate 3 operating modes:



4.1.1 Parameters, Parameter Groups, Parameter Sets

What are parameters, parameter groups and parameter sets?

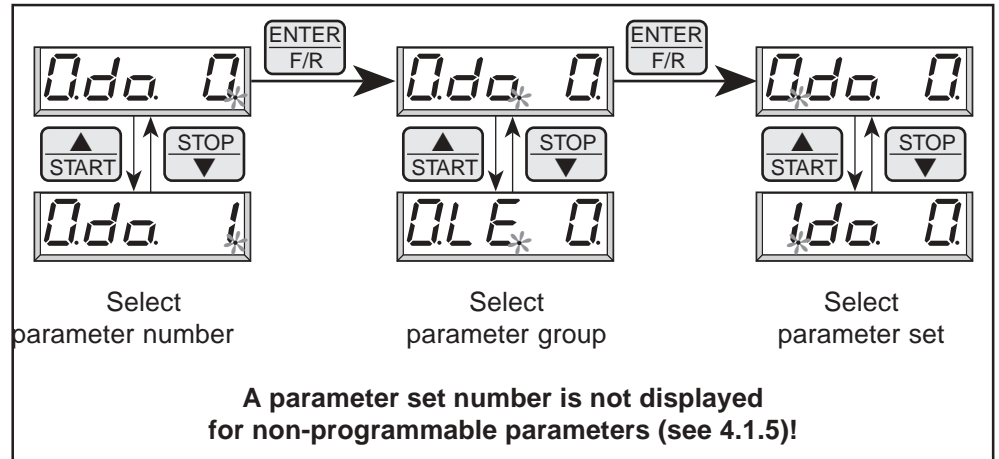
Parameters are values changeable by the operator in a program, which have an influence on the program flow. A parameter consists of



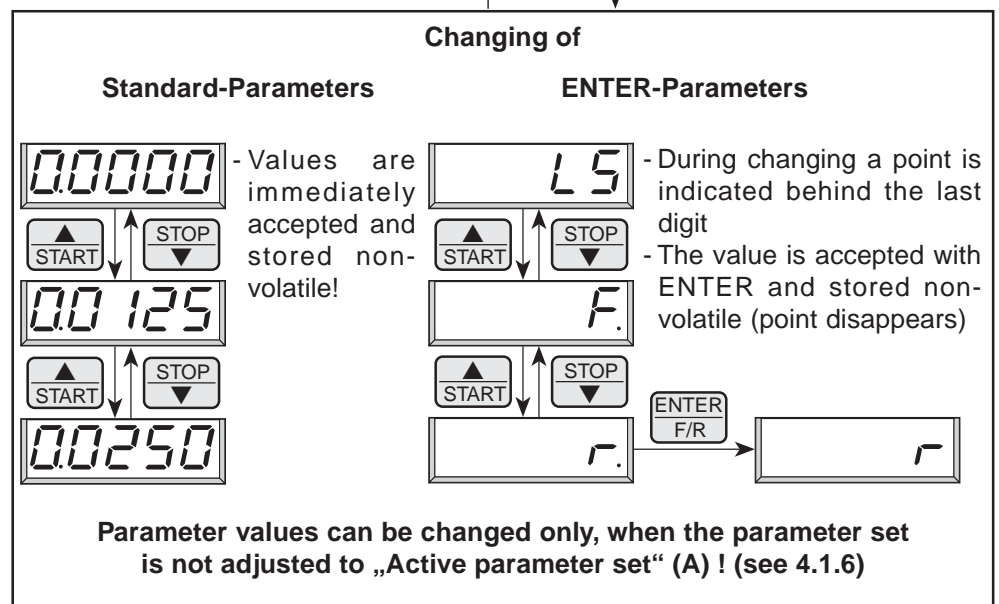
Example: A conveyor belt shall be used with 3 different speeds. A parameter set is programmed for each „speed“ ... acceleration, deceleration etc. can be adjusted individually.

4.1.2 Selection of a Parameter

The blinking point indicates the changeable area. By pressing the ENTER-key the blinking point is shifted.



4.1.3 Adjustment of Parameter Values



4.1.4 ENTER-Parameter

For some parameters it is not sensible that the selected values become active immediately. For that reason they are called ENTER-parameters, they do not become active until the ENTER-key is pressed.

Example: At digital setting of rotation direction the rotation reverse (r) shall be selected from standstill (LS). As shown above, the actuation must be done via rotation forward (F). However, the drive must not start yet, first the rotation direction reverse has to be selected and confirmed with ENTER (point disappears).

4.1.5 Non-programmable Parameters

Certain parameters are not programmable, as their value must be the same in all sets (e.g. bus address or baud rate). For an easy identification of these parameters the parameter set number is missing in the parameter identification. **For all non-programmable parameters the same value is valid independent of the selected parameter set!**

4.1.6 Resetting of Error Messages

If a malfunction occurs during operation, the actual display is overwritten by a blinking error message. The error message can be cancelled by pressing the ENTER-key, so that the original value is again shown in the display.

ATTENTION! The resetting of the error message with ENTER is no error reset, i.e. the error status in the inverter is not reset. Thus it is possible to correct adjustments before the error reset. An error reset is only possible through the reset terminal or control release.

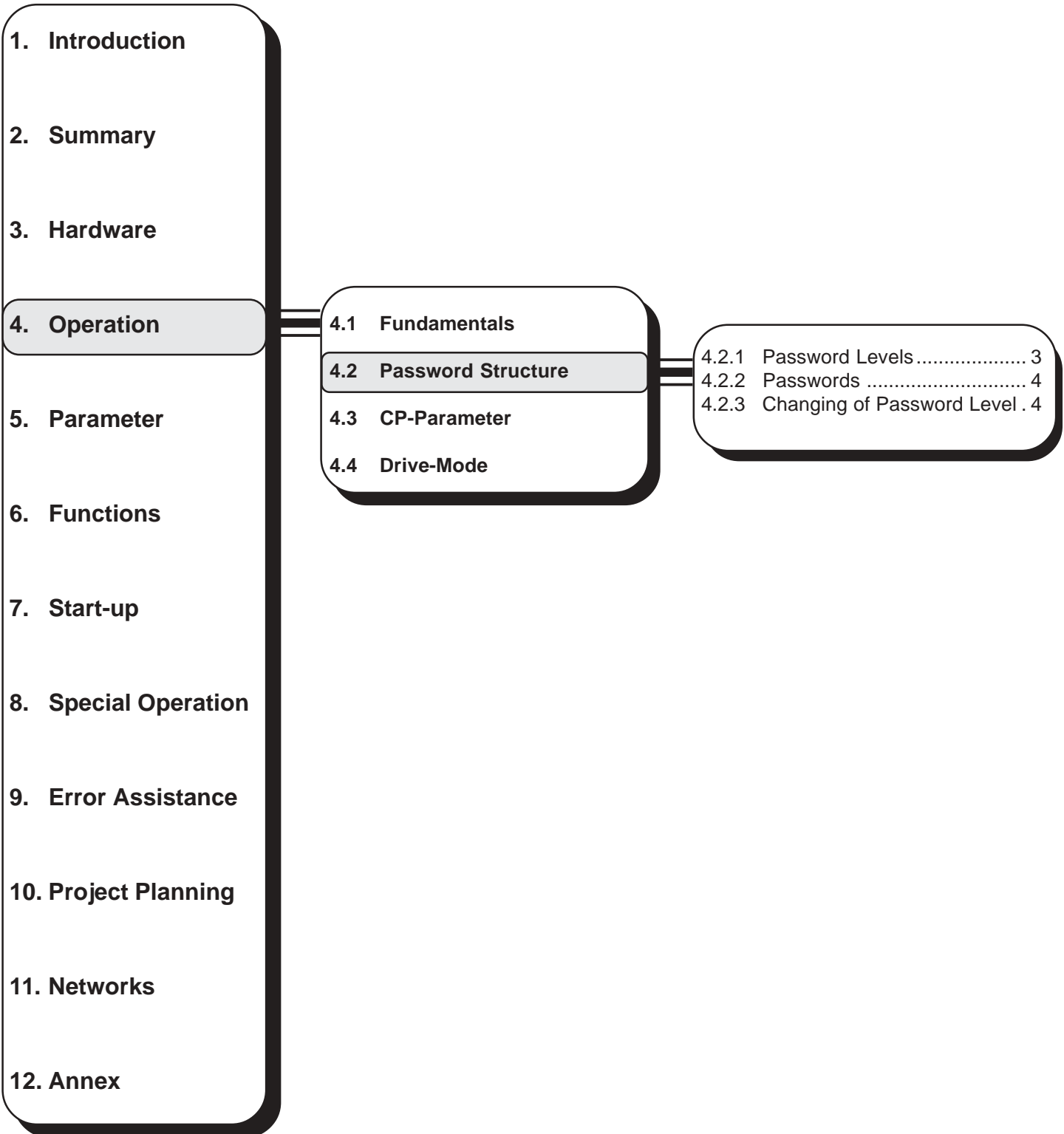
4.1.7 Resetting of Peak Values

To permit conclusions on the operational performance of the drive, parameters are provided that indicate the peak values. Peak value means that the highest measured value is stored for the ON-time of the inverter (slave pointer principle). The peak value is cancelled by ▲ or ▼ and the actual measured value is shown in the display.

4.1.8 Acknowledgement of Status Signals

To monitor the correct execution of an action some parameters send a status signal. For example, after copying a set the display shows „PASS“ to indicate that the action was carried out without error. These status signals must be acknowledged with ENTER.

Chapter 4	Section 1	Page 6	Date 10.04.02	Name: Basis KEB COMBIVERT F5	© KEB Antriebstechnik, 2002 All Rights reserved
---------------------	---------------------	------------------	------------------	--	--



Chapter 4	Section 2	Page 2	Date 10.04.02	Name: Basis KEB COMBIVERT F5	© KEB Antriebstechnik, 2002 All Rights reserved
---------------------	---------------------	------------------	------------------	--	--

4.2 Password Structure

The KEB COMBIVERT is provided with extensive password protection. The different passwords are used to

- change the operating mode
- set a write protection
- activate the Service-Mode
- switch to the Drive-Mode

Depending on the actual operating mode the password can be entered in following parameters



when the CP-Mode is active



when the application mode is active

4.2.1 Password Levels

The parameter value of the above parameters shows the actual password level. Following indications are possible:



CP - read only

Only the Customer-parameter group is visible, except for CP.0 all parameters are in the read-only status (see chapter 4.3).



CP - on

Only the Customer-parameter group is visible. All parameters can be changed.



CP - Service

Like CP-on, but the parameter identification is indicated according to the original parameter (see chapter 4.3).



Application

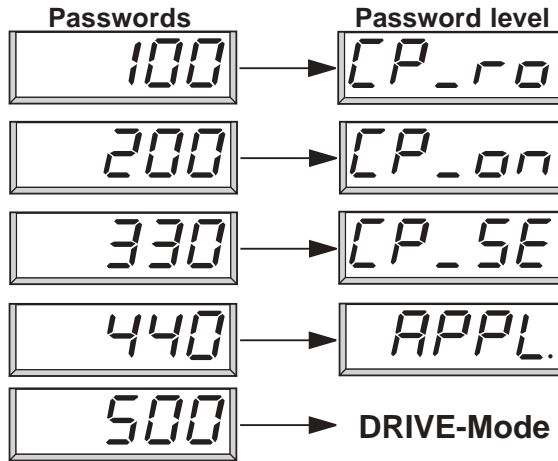
All application parameters are visible and can be changed. The CP-parameters are not visible.

Drive-Mode

The Drive-Mode is a special operating mode, here the unit can be put into operation via the operator (see chapter 4.4).

4.2.2 Passwords

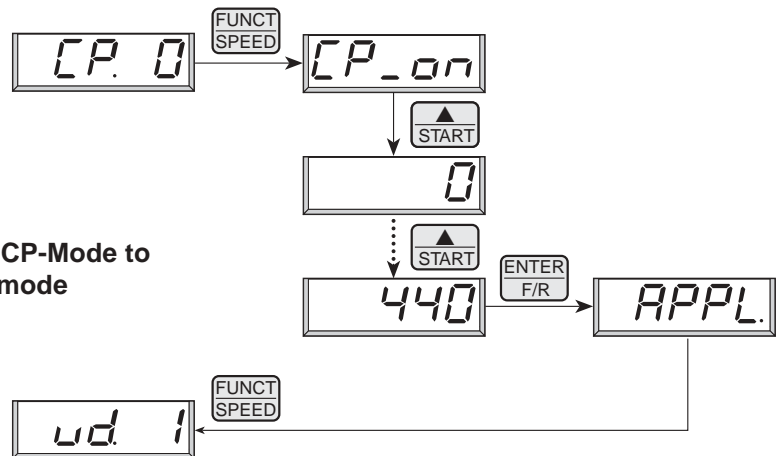
By selecting one of the following passwords you can switch to the respective password level:



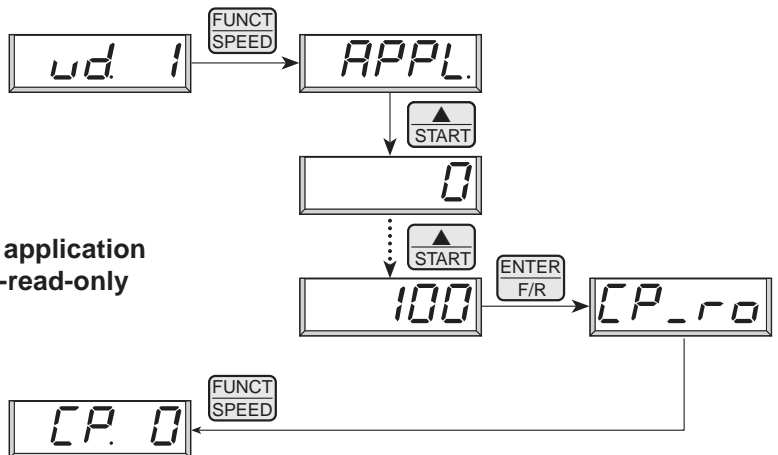
To finish the Drive-Mode press ENTER + FUNCT key for approx. 3 sec. (see chapter 4.4).

4.2.3 Changing of Password Level

Example 1:
Switching from CP-Mode to the application mode



Example 1:
Switching from application mode to the CP-read-only mode



i With the exception of the service password all entered password levels are generally stored non-volatile!

1. Introduction		
2. Summary		
3. Hardware		
4. Operation	<ul style="list-style-type: none"> 4.1 Fundamentals 4.2 Password Structure 4.3 CP-Parameter 4.4 Drive-Mode 	<ul style="list-style-type: none"> 4.3.1 Operation in CP-Mode 3 4.3.2 Factory Setting 4 4.3.3 Password input 5 4.3.4 Status Display 5 4.3.5 Basic Adjustment of the Drive 7 4.3.6 Special Settings 10
5. Parameter		
6. Functions		
7. Start-up		
8. Special Operation		
9. Error Assistance		
10. Project Planning		
11. Networks		
12. Annex		

Chapter	Section	Page	Date	Name: Basis	©	KEB Antriebstechnik, 2001 All Rights reserved
4	3	2	04.12.01	KEB COMBIVERT F5-G / B		

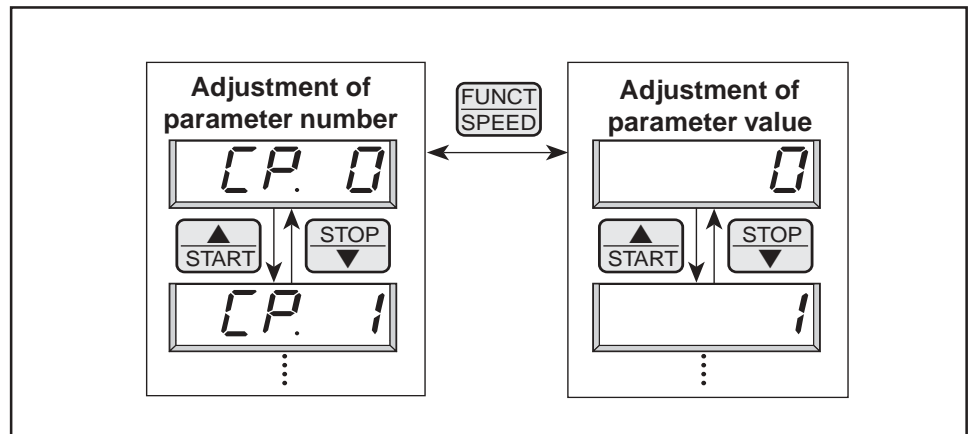
4.3 CP-Parameter

The Customer-Parameters (CP) are a special group of parameter. With the exception of CP.0 (Password input), they can be defined by the user (see Chapter 6.13). The following Parameters are preset at delivery.

Advantages from it: - operator-friendly for the customer
 - critical parameters are protected against maloperation
 - low documentation cost for the machine builder

4.3.1 Operation in CP-Mode

Compared to the Application-Mode the operation in the CP-Mode is easier because parameter set selection and parameter group selection are unnecessary.



4.3.2 Factory Setting

The following list shows the CP-parameter group predefined by us. The definition of the CP-parameters is done in the User-Definition-Parameters (ud). How you can define your own parameters is described in Chapter 6.13.

Display	Parameter	Setting range	Resolution	Factory setting	Appl. Parameter
CP. 0	Password input	0...9999	1	–	ud.1 / 0801h
CP. 1	Actual frequency display	–	0,0125 Hz	–	ru.3 / 0203h
CP. 2	Set frequency display	–	0,0125 Hz	–	ru.1 / 0201h
CP. 3	Inverter status display	–	–	–	ru.0 / 0200h
CP. 4	Apparent current	–	0,1 A	–	ru.15 / 020Fh
CP. 5	Apparent current / Peak value	–	0,1 A	–	ru.16 / 0210h
CP. 6	Utilization	–	1 %	–	ru.13 / 020Dh
CP. 7	Intermediate circuit voltage	–	1 V	–	ru.18 / 0212h
CP. 8	Intermediate circuit voltage/ Peak value	–	1 V	–	ru.19 / 0213h
CP. 9	Output voltage	–	1 V	–	ru.20 / 0214h
CP.10	Minimal frequency	0...400 Hz	0,0125 Hz	0 Hz	op.6 / 0306h
CP.11	Maximal frequency	0...400 Hz	0,0125 Hz	70 Hz	op.10 / 030Ah
CP.12	Acceleration time	0,00...300,00 s	0,01 s	5,00 s	op.28 / 031Ch
CP.13	Deceleration time (-1 = CP.12)	-0,01; 0,00...300,00s	0,01 s	5,00 s	op.30 / 031Eh
CP.14	S-curve time	0,00 (off)...5,00 s	0,01 s	0,00 s (off)	op.32 / 0320h
CP.15	Boost	0,0...25,5 %	0,1 %	2,0 %	uf.1 / 0501h
CP.16	Rated frequency	0...400 Hz	0,0125 Hz	50 Hz	uf.0 / 0500h
CP.17 ¹⁾	Voltage stabilization	1...650 V (off)	1 V	650 (off)	uf.9 / 0509h
CP.18 ¹⁾	Carrier frequency	0...4 ²⁾	1	– ²⁾	uf.11 / 050Bh
CP.19	Fixed frequency 1	-400...400 Hz	0,0125 Hz	5 Hz	op.21 / 0315h
CP.20	Fixed frequency 2	-400...400 Hz	0,0125 Hz	50 Hz	op.22 / 0316h
CP.21	Fixed frequency 3	-400...400 Hz	0,0125 Hz	70 Hz	op.23 / 0317h
CP.22 ¹⁾	DC-braking / Mode	0...9	1	7	pn.28 / 041Ch
CP.23	DC-braking / Time	0,00...100,00 s	0,01 s	10,00 s	pn.30 / 041Eh
CP.24	Max. ramp current	0...200 %	1 %	140 %	pn.24 / 0418h
CP.25	Max. constant current	0...200 % (off)	1 %	200 % (off)	pn.20 / 0414h
CP.26 ¹⁾	Speed search condition	0...15	1	8	pn.26 / 041Ah
CP.27	Quick stop time	0,00...300,00 s	0,01 s	2,00 s	pn.60 / 043Ch
CP.28	Reaction of ext. overtemperature	0...7	1	7	pn.12 / 040Ch
CP.29 ¹⁾	Analog output 1 / Function	0...12	1	2	an.31 / 0A1Fh
CP.30	Analog output 1 / Amplification	-20,00...20,00	0,01	1,00	an.33 / 0A21h
CP.31 ¹⁾	Relay output 1 / function	0...42	1	4	do.2 / 0C02h
CP.32 ¹⁾	Relay output 2 / function	0...42	1	27	do.3 / 0C03h
CP.33	Relay output 2 / switching level	-30000,00...30000,00	0,01	4,00	le.3 / 0D03h
CP.34 ¹⁾	Source of rotation direction	0...9	1	2	op.1 / 0301h
CP.35 ¹⁾	AN1 interface selection	0...2	1	0	an.0 / 0A00h
CP.36	AN1 zero point hysteresis	-10,0...10,0 %	0,1 %	0,2 %	an.4 / 0A04h

¹⁾ Enter-Parameter

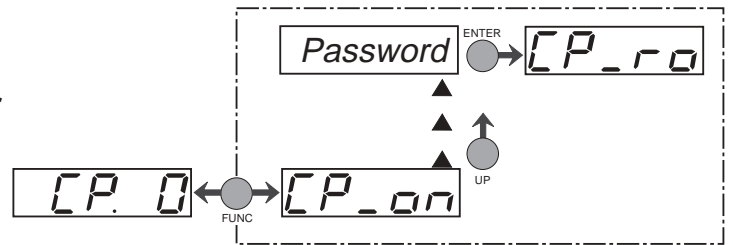
²⁾ depending on power circuit

4.3.3 Password Input

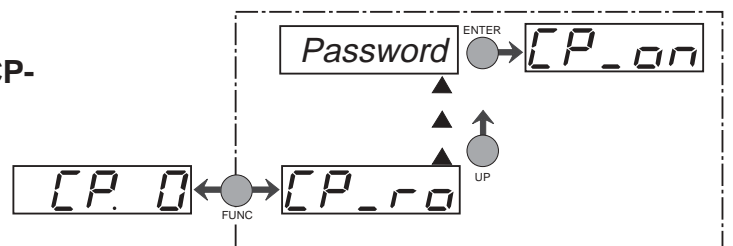


Ex works the frequency inverter is supplied without password protection, this means that all changeable parameters can be adjusted. After parameterizing the unit can be barred against unauthorized access (Passwords: see chapter 4.2). The adjusted mode is stored.

Barring the CP-Parameter



Enabling the CP-Parameter



4.3.4 Operating Display

The parameters below serve for the controlling of the frequency inverter during operation.

Actual frequency display



Display of the actual output frequency with a resolution of 0.0125 Hz. The operator displays additionally „noP“ and „LS“ if the control release or the direction of rotation are not switched (see CP.3). The rotation of the inverter is indicated by the sign.

- Examples:
- Output frequency 18.3 Hz, rotation forward
 - Output frequency 18.3 Hz, rotation reverse

Set frequency



Display of actually set frequency. The indication is done in the same manner as at CP.1. For control reasons the set frequency is displayed even if control release or direction of rotation are not switched. If no direction of rotation is set, the set frequency for clockwise rotation (forward) is displayed.

Inverter status display



The status display shows the actual working conditions of the inverter. Possible displays and their meanings are:

- "no Operation" control release not bridged, modulation switched off, output voltage = 0 V, drive is not controlled.
- "Low Speed" no rotation preset, modulation switched off, output voltage = 0 V, drive is not controlled.

FAcc

"Forward Acceleration" drive accelerates with direction of rotation forward .

FdEc

"Forward Deceleration" drive decelerates with direction of rotation forward.

rAcc

"Reverse Acceleration" drive accelerates with direction of rotation reverse.

rdEc

"Reverse Deceleration" drive decelerates with direction of rotation reverse.

Fcon

"Forward Constant" drive runs with a constant speed and direction of rotation forward.

rcon

"Reverse Constant" drive runs with constant speed and direction of rotation reverse.

Other status messages are described at the parameters, where they occur.

Apparent current

CP. 4

Display of the actual apparent current in ampere.

**Apparent current /
Peak value**

CP. 5

CP.5 makes it possible to recognize the max. apparent current. For that the highest value of CP.4 is stored in CP.5. The peak value memory can be cleared by pressing the UP, DOWN or ENTER key or over bus by writing any value you like to the address of CP.5. The switch off of the inverter also clears the memory.

Utilization

CP. 6

Display of the actual inverter rate of utilization in percent. 100% rate of utilization is equal to the inverter rated current. Only positive values are displayed, meaning there is no differentiation between motor and regenerative operation.

Intermediate circuit voltage

CP. 7

Display of actual DC voltage in volt.
Typical values:

V-class	Normal operation	Over volt. (E.OP)	Under volt. (E.UP)
230 V	300...330 V DC	approx. 400 V DC	approx. 216 V DC
400 V	530...620 V DC	approx. 800 V DC	approx. 240 V DC

**Intermediate circuit voltage/
Peak value**



CP.8 makes it possible to recognize short-time voltage rises within an operating cycle. For that the highest value of CP.7 is stored in CP.8. The peak value memory can be cleared by pressing the UP, DOWN or ENTER key or over bus by writing any value you like to the address of CP.8. The switch off of the inverter also clears the memory.

Output voltage



Display of the actual output voltage in volt.

**4.3.5 Basic Adjustment
of the Drive**

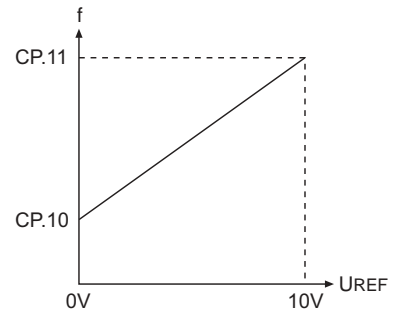
The following parameters determine the fundamental operating data of the drive. They should be checked and/or adapted to the application.

Minimum frequency



With this frequency the inverter operates without presetting an analog set value. Internal limiting of the fixed frequencies CP.19...CP.21.

Adjustment range: 0...400 Hz
Resolution: 0,0125 Hz
Factory setting: 0,0 Hz



Maximum frequency



With this frequency the inverter operates with maximum analog set value. Internal limiting of the fixed frequencies CP.19...CP.21.

Adjustment range: 0...400 Hz
Resolution: 0,0125 Hz
Factory setting: 70 Hz

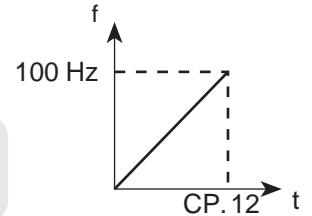
Acceleration time

CP.12

The parameter determines the time needed to accelerate from 0 Hz to 100 Hz. The actual acceleration time is proportional to the frequency change.

$$\frac{100 \text{ Hz}}{\Delta f} \times \text{actual acceleration time} = \text{CP.12}$$

Adjustment range: 0,00...300,00 s
 Resolution: 0,01 s
 Factory setting: 5,00 s



Example: actual acceleration time = 5s; the drive should accelerate from 10 Hz to 60 Hz. $\Delta f = 60 \text{ Hz} - 10 \text{ Hz} = 50 \text{ Hz}$

$$\text{CP.12} = (100 \text{ Hz} / 50 \text{ Hz}) \times 5 \text{ s} = 10 \text{ s}$$

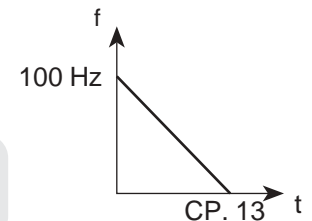
Deceleration time

CP.13

The parameter determines the time needed to decelerate from 100 Hz to 0 Hz. The actual deceleration time is proportional to the frequency change.

$$\frac{100 \text{ Hz}}{\Delta f} \times \text{actual deceleration time} = \text{CP.13}$$

Adjustment range: -0,01; 0,00...300,00 s
 Resolution: 0,01 s
 Factory setting: 5,00 s



At deceleration time = -0,01 see CP.12 (Display: "=Acc")!

Example: actual deceleration time = 5s; the drive should decelerate from 60 Hz to 10 Hz. $\Delta f = 60 \text{ Hz} - 10 \text{ Hz} = 50 \text{ Hz}$

$$\text{CP.12} = (100 \text{ Hz} / 50 \text{ Hz}) \times 5 \text{ s} = 10 \text{ s}$$

S-curve time

CP.14

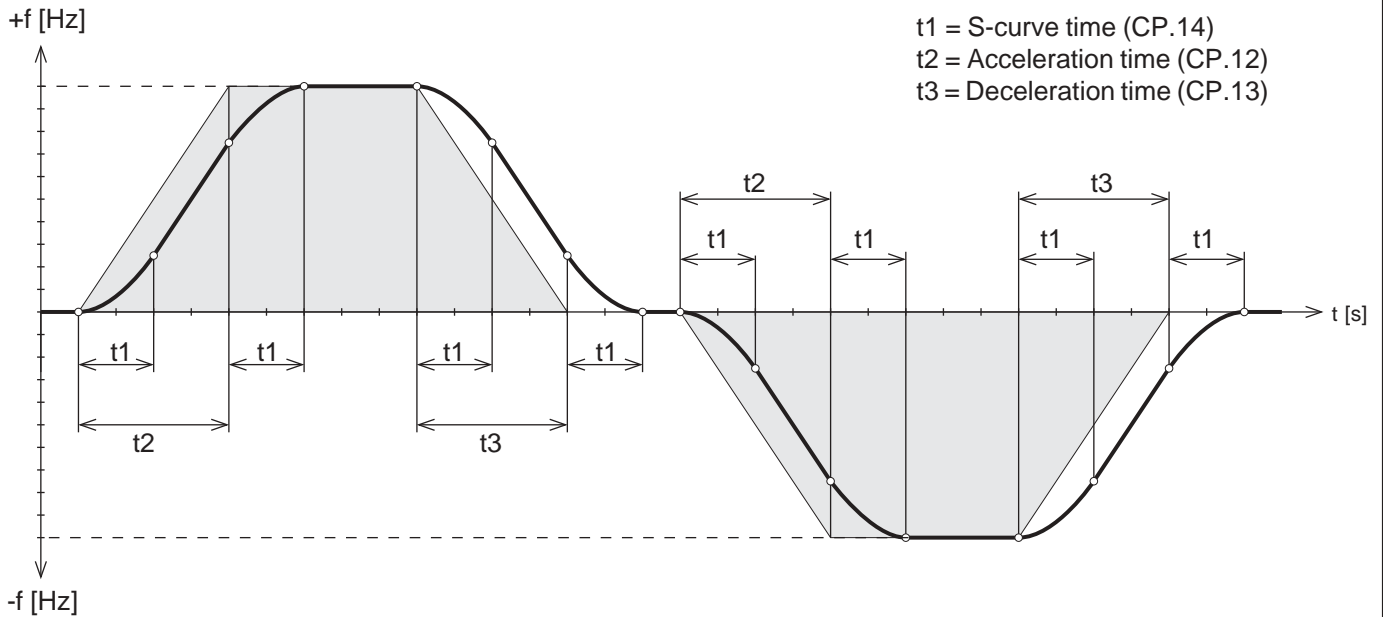
For some applications it is of advantage when the drive starts and stops jerk-free. This is achieved through a straightening of the acceleration and deceleration ramps. The straightening time, also called S-curve time, can be adjusted with CP.14.

Adjustment range: 0,00 (off)...5,00 s
 Resolution: 0,01 s
 Factory setting: 0,00 s (off)



In order to drive defined ramps with activated S-curve time, the acceleration and deceleration times (CP.12 and CP.13) must be adjusted higher than the S-curve time (CP.14).

Ramp adjustment with S-curves

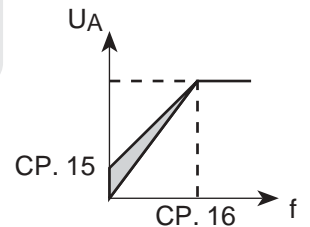


Boost



In the lower speed range a large part of the motor voltage decreases on the stator resistance. To keep the breakdown torque nearly constant over the entire speed range, the voltage decrease can be compensated with the boost.

Adjustment range: 0,0...25,5 %
 Resolution: 0,1 %
 Factory setting: 2,0 %



- Adjustment:
- Determine the rate of utilization in no-load operation with rated frequency
 - Preset about 10 Hz and adjust the boost, so that about the same rate of utilization is reached as with the rated frequency.



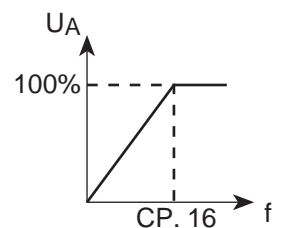
When the motor, during continuous operation, drives with low speed and too high voltage it can lead to an overheating of the motor.

Rated frequency



With the adjusted frequency the inverter reaches a maximal output voltage. The adjustment of the rated motor frequency is typical in this case. **Note: Motors can overheat when the rated frequency is incorrectly adjusted!**

Adjustment range: 0...400 Hz
 Resolution: 0,0125 Hz
 Factory setting: 50 Hz



4.3.6 Special Adjustments

The following parameters serve for the optimization of the drive and the adaption to certain applications. These adjustments can be ignored at the initial startup.

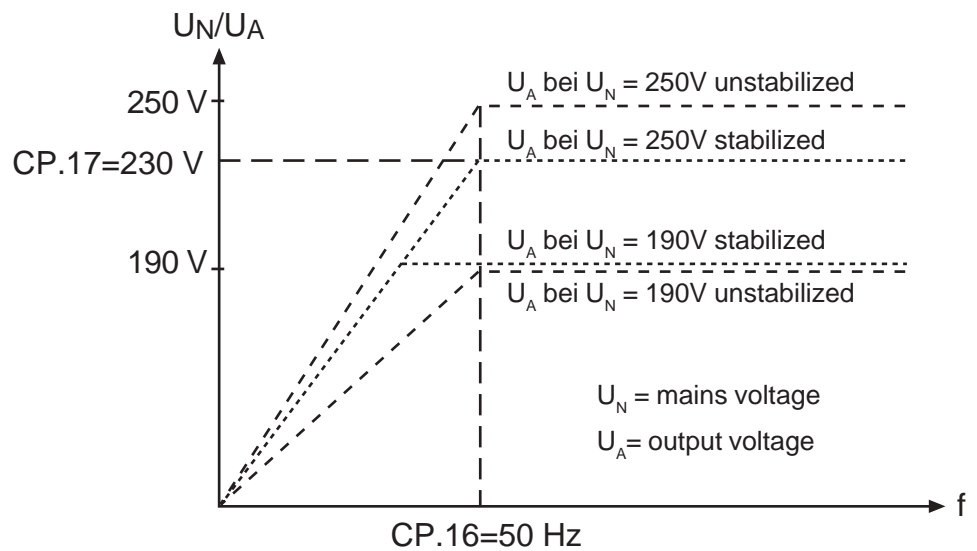
Voltage stabilization



With this parameter a regulated output voltage in relation to the rated frequency can be adjusted. For that reason voltage variations at the input as well as in the intermediate circuit only have a small influence on the output voltage (U/f-characteristic). The function allows, among other things, an adaption of the output voltage to special motors.

Adjustment range:	1...650 V (off)
Resolution:	1 V
Factory setting:	650 V (off)
Note:	Enter-Parameter

In the example below the output voltage is stabilized to 230 V (0% boost).



Carrier frequency



The switching frequency with which the power modules are clocked can be changed depending on the application. The employed power stage determines the maximum switching frequency as well as the factory setting (see manual: part2). Refer to following list to learn about influences and effects of the switching frequency.

low switching frequency	high switching frequency
<ul style="list-style-type: none"> • less inverter heating • less discharge current • less switching losses • less radio interferences • improved concentricity with low speed 	<ul style="list-style-type: none"> • less noise development • improved sine-wave simulation • less motor losses

Adjustment range (depending on power circuit): 2 / 4 / 8 / 12 / 16 kHz
 Factory setting: depending on power circuit
 Note: Enter-Parameter



At switching frequencies above 4 kHz pay absolute attention to the max. motor line length in the technical data of the chapter 2.1.

Step frequency 1...3

Input I1



Input I2



Input I1 and I2



Three fixed frequencies can be adjusted. The fixed frequencies are selected with the inputs I1 and I2.

Adjustment range: -400...400 Hz
 Resolution: 0,0125 Hz
 Factory setting CP.19: 5 Hz
 Factory setting CP.20: 50 Hz
 Factory setting CP.21: 70 Hz

If adjustments are made that are outside the fixed limits of CP.10 and CP.11, then the frequency is internally limited. The negative values are released in application mode. The rotation source of the fixed frequencies is not changed by CP.34, it always corresponds to CP.34 = 2.

DC-braking / Mode

CP.22

With DC-braking the motor is not decelerated by the ramp. Quick braking is caused by D.C. voltage, which is applied onto the motor winding. This parameter determines how the dc-braking is triggered.

Value	Activation
0	DC-braking deactivated
1	DC-braking at switch off of the direction of rotation and upon reaching 0Hz. The braking time is CP.23 or until the next direction of rotation.
2*	DC-braking as soon as setting for the direction of rotation is absent.
3*	DC-braking as soon as the direction of rotation changes or is absent.
4*	DC-braking on disabling the direction of rotation and if the real frequency falls below 4 Hz.
5*	DC-braking when the real frequency falls below 4 Hz.
6*	DC-braking as soon as the set value falls below 4 Hz.
7*	DC-braking when input I4 is switched. Braking time depends on the real frequency. At control circuit B = value "0"
8	DC-braking as long as input I4 is switched. At control circuit B = value "0"
9	DC-braking after switching on the modulation on.

* Braking time depends on the actual frequency.

Adjustment range: 0...9
 Resolution: 1
 Factory setting: 7
 Note: Enter-Parameter

DC-braking / Time

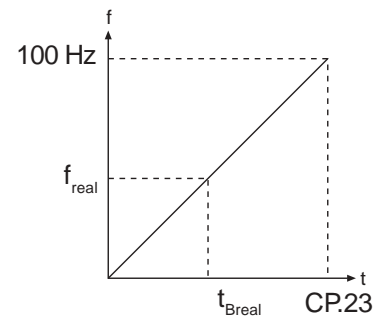
CP.23

If the braking time depends on the actual frequency (CP.22 = 2...7), it is calculated as follows:

$$t_{\text{Breal}} = \frac{\text{CP.23} \times f_{\text{real}}}{100 \text{ Hz}}$$

Otherwise the braking time corresponds to CP.23.

Adjustment range: 0,00...100,00 s
 Resolution: 0,01 s
 Factory setting: 10,00 s



Max. ramp current



This function protects the frequency inverter against switching off through overcurrent during the acceleration ramp. When the ramp reaches the adjusted value, it is stopped so long until the current decreases again. CP.3 displays "LAS" at active function.

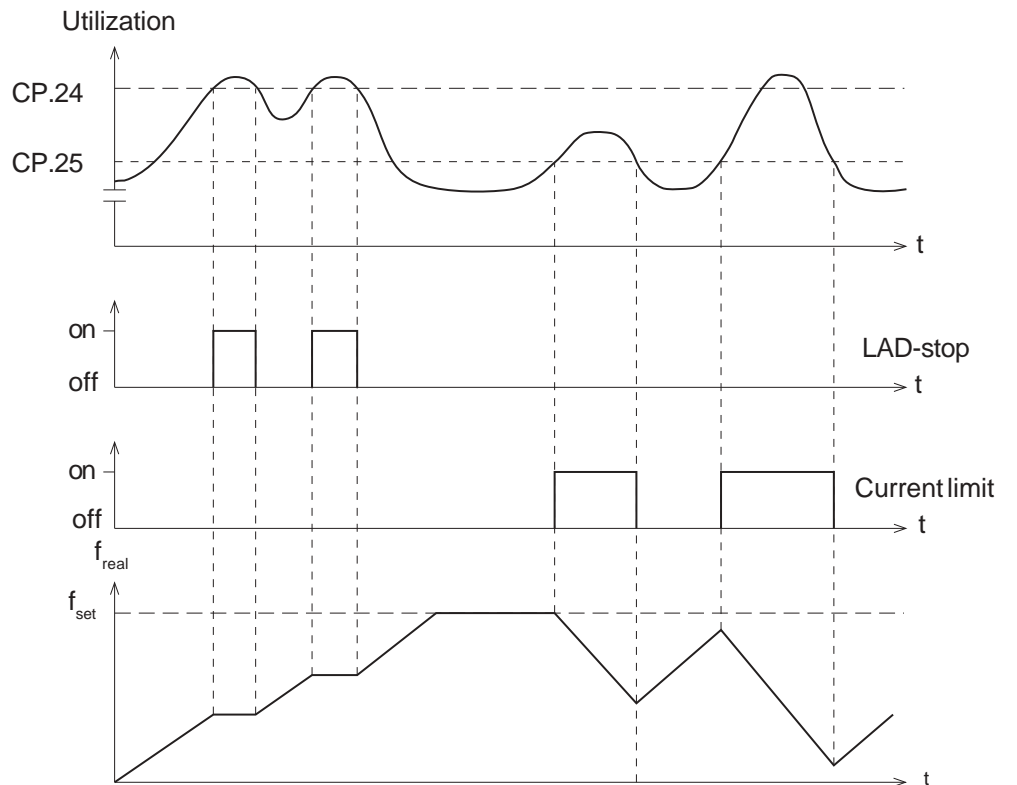
Adjustment range:	0...200 %
Resolution:	1 %
Factory setting:	140 %

Max. constant current



This function protects the frequency inverter against switch off through overcurrent during constant output frequency. When exceeding the adjusted value, the output frequency is reduced until the value drops below the adjusted value. CP. 3 displays "SSL" at active function.

Adjustment range:	0...200 % (off)
Resolution:	1 %
Factory Setting:	200 % (off)



Speed search condition



When connecting the frequency inverter onto a decelerating motor, an error can be triggered by the differing rotating field frequencies. With activated speed search the inverter searches for the actual motor speed, adapts its output frequency and accelerates with the adjusted ramp to the given set value. During speed search CP.3 displays "SSF". The parameter determines, under what conditions the functions operate. In case of several conditions the sum of the value must be entered.

Example: CP.26 = 12 means after reset **and** after auto-reset UP.

Value	Condition
0	function off
1	at control release
2	at switch on
4	after reset
8	after Auto-Reset UP

Adjustment range: 0...15
 Resolution: 1
 Factory setting: 8
 Note: Enter-Parameter

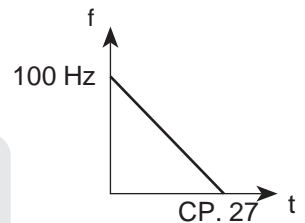
Quick stop time



The fast-stop function is activated depending on CP.28. The parameter determines the time needed to decelerate from 100 Hz to 0 Hz. The actual deceleration time is proportional to the frequency change. The response to overtemperature (CP.28) is disabled in the factory setting. If it is activated then the modulation switches off automatically after 10 s if the motor is still too hot.

$$\frac{100 \text{ Hz}}{\text{delta } f} \times \text{actual deceleration time} = \text{CP.27}$$

Adjustment range: 0,00...300,00 s
 Resolution: 0,01 s
 Factory setting: 2,00 s



Example: actual deceleration time = 5s; the drive should decelerate from 50 Hz to 0 Hz. delta f = 50 Hz - 0 Hz = 50 Hz

$$\text{CP.27} = (100 \text{ Hz} / 50 \text{ Hz}) \times 5 \text{ s} = 10 \text{ s}$$

Reaction of
external overtemperature



This parameter determines the response of the drive on the external temperature monitoring (**factory setting = off**). In order to activate this function the power circuit terminals T1/T2 must be connected in accordance with the instruction manual Part 2. After that the response can be adjusted according to following table. If overheat no longer exists, the message E.ndOH (or A.ndOH) is output. Only then the error can be reset or the automatic restart can be carried out.

CP.28	Display	Reaction	Restart
0	E.dOH	Immediate disabling of modulation	Remove fault; Actuate reset
1 *	A.dOH	Quick stopping / disabling of modulation after reaching speed 0	
2 *	A.dOH	Quick stopping/holding torque at speed 0	
3	A.dOH	Immediate disabling of modulation	Automatic reset, if the fault is no longer present
4 *	A.dOH	Quick stopping / disabling of modulation after reaching speed 0	
5 *	A.dOH	Quick stopping/holding torque at speed 0	
6 *	no	No effect on the drive; With CP.31/32 = 9 an external module can be controlled (e.g. fan)	- inapplicable -
7	no	No effect on the drive; !Störung existiert nicht! External Temperature monitoring is not activated	

*) If the motor is still too hot after 10 seconds, the error E.dOH is triggered and the modulation is switched off!

Adjustment range:	0...7
Resolution:	1
Setting range:	7

Analog output 1 / Function

CP.29

CP.32 defines the function of analog output 1.

Value	Function	
0	absolute actual value	100 Hz
1	absolute set value	100 Hz
2	actual value ru.7	±100 Hz
3	set value ru.1	±100 Hz
4	output voltage ru.20	500 V
5	DC voltage ru.18	1000 V
6	apparent current ru.15	$2 \cdot I_{rated}$
7	active current ru.17	$2 \cdot \pm I_{rated}$
8	digital An.32/An.37/An.42	100 %
9	external PID output ru.52	±100 %
10	absolute ext. PID output ru.52	100 %
11	absolute active current ru.17	$2 \cdot I_{rated}$
12	power mod. temperature ru.38	100°C
13	motor temperature	0...100 °C
14-18	application mode only	
19	ramp output frequency	0...±100 Hz
20	absolute ramp output frequency	0...100 Hz

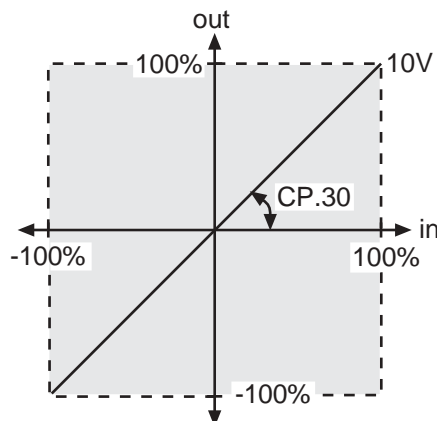
Adjustment range: 0...20
 Resolution: 1
 Factory setting: 2
 Note: Enter-Parameter

Analog output 1 / Amplification

CP.30

With the amplification the output voltage of the analog output can be tuned the signal to be given out. An amplification of 1 corresponds to ±100 % = ±10 V.

Adjustment range: -20,00...20,00
 Resolution: 0,01
 Factory setting: 1,00



Setting aid:
 The analog output shall give out +10 V at 70 Hz instead at 100 Hz:

$$CP.30 = \frac{100 \text{ Hz}}{70 \text{ Hz}} = 1,43$$

Relay output 1 / Function

CP.31

Relay output 2 / Function

CP.32

CP.31 and CP.32 determine the function of the two outputs.
 CP.31 for relay output 1 (terminal X2A.24...X2A.26)
 CP.32 for relay output 2 (terminal X2A.27...X2A.29)

The switching level of CP.32 is CP.33!

Value	Function
0	No function (generally off)
1	Generally on
2	Run signal; also by DC-braking
3	Ready signal (no error)
4	Fault relay
5	Fault relay (not at under voltage error)
6	Warning or error message at abnormal stopping
7	Overload alert signal
8	Overtemperature alert signal power modules
9	External Overload alert signal motor
10	Only application-mode
11	Excess-temperature alert signal interior OHI
12	Cable breakage 4...20 mA on analog input 1
13	Only application-mode
14	Max. constant current (stall, CP.25) exceeded
15	Max. ramp current (LA-Stop CP.24) exceeded
16	DC-braking active
17-19	Only application-mode
20	Actual value=set value (CP.3=Fcon, rcon; not at noP, LS error,SSF)
21	Accelerate (CP.3 = FAcc, rAcc, LAS)
22	Decelerate (CP.3 = FdEc, rdEc, LdS)
23	Real direction of rotation = set direction of rotation
24	Utilization (CP.6) > 100% (only CP.31)
25	Active current > switching level (only CP.32)
26	Intermediate circuit voltage (CP.7)>switching level (only CP.32)
27	Real value (CP.1) > switching level (only CP.32)
28	Set value (CP.2) > switching level (only CP.32)
29/30	Only application-mode
31	Absolut set value on AN1 > switching level (only CP.32)
32	Absolut set value on AN2 > switching level (only CP.32)
33	Only application-mode
34	Set value on AN1 > switching level (only CP.32)
35	Set value on AN2 > switching level (only CP.32)
36-39	Only application-mode
40	Hardware current limit activated
41	Modulation on-signal
42-43	Only application-mode
44	Inverter status (CP.3) = switching level
45	Power module temperatur > Level
46	Motor temperatur > Level
47	Ramp output frequency > Level
48	Apparent current (CP.4) > Level
49	Clockwise rotation (not at noP, LS, abnormal stopping, Fehler)
50	Counter clockwise (not at noP, LS, abnormal stopping, Fehler)
51-62	Only application-mode
63	Absolut ANOUT1 > switching level
64	Absolut ANOUT2 > switching level
65	ANOUT1 > switching level
66	ANOUT2 > switching level
67-68	Only application-mode

Factory setting CP.31: 4
 Factory setting CP.32: 27
 Note: Enter-Parameter

**Relay output 2 /
 Switching level**



This parameter determines the switching point for the relay output 2 (CP.32). After the switching of the relay, the value can move within a window (hysteresis), without the relay dropping off. Since the operator can display only 5 characters, the last digits are not represented in the case of higher values.

Adjustment range: -30000,00...30000,00
 Resolution: 0,01
 Factory setting: 4,00
 Hysteresis:
 Frequency: 0,5 Hz
 Voltage: 1 V
 Analog values: 0,5 %
 Current: 0,5 A
 Temperature 1 °C

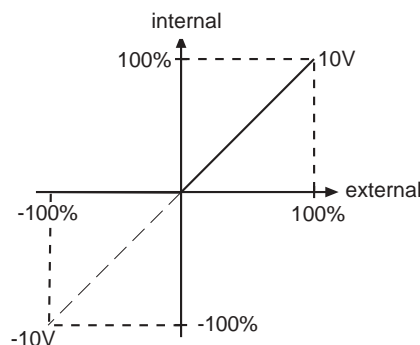
Source of rotation direction



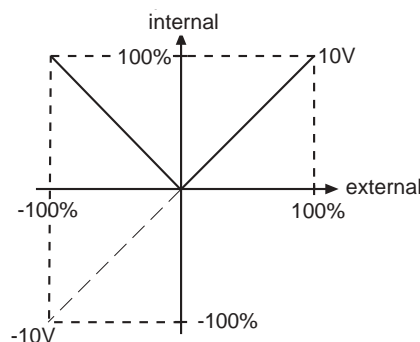
The source rotation setting and the mode of evaluating the rotation setting is defined with this parameter (Enter-Parameter). With CP.34 one does not modify the rotation source of the fixed frequencies (CP.19... 21).

Value	Function
0/1	Only application mode
2	Setting by way of terminal strip forward/reverse; negative set values are set to zero (factory setting)
3	Setting by way of terminal strip forward/reverse; the signs of the setpoint values have no effect on the direction of rotation
4	Setting by way of terminal strip run/stop (X2A.14) and forward/reverse (X2A.15); negative values are set to zero
5	Setting by way of terminal strip run/stop (X2A.14) and forward/reverse; the signs of the setpoint values have no effect on the direction of rotation
6	Set value dependent, positive value - clockwise rotation; negative value - counterclockwise rotation; with set value "0" it is switched into status "Low speed" (LS)
7	Set value dependent, positive value - clockwise rotation; clockwise rotation is indicated
8/9	Only application mode

Set value
0-limited
(Value 2 and 4)



Set value
absolute
(Value 3 and 5)



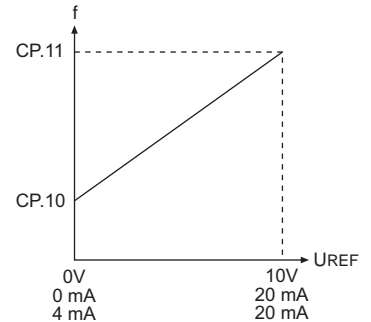
Adjustment range: 0...9
Resolution: 1
Factory setting: 2
Note: Enter-Parameter

AN1 Interface selection



The set value input 1 (AN1) at the F5-GENERAL control can be triggered by various signal levels. In order to correctly evaluate the signal, this parameter must be adapted to the signal source. At the F5-BASIC control the signal source may not be re-adjusted.

Value	Reference signal
0	0...±10 V DC / Ri = 56 kOhm
1	0...±20 mA DC / Ri = 250 Ohm
2	4...20 mA DC / Ri = 250 Ohm



Adjustment range: 0...2
 Resolution: 1
 Factory setting: 0
 Note: Enter-Parameter

AN1 Zero point hysteresis



Through capacitive as well as inductive coupling on the input lines or voltage fluctuations of the signal source, the motor connected to the inverter may start to drift in spite of the analog input filters. It is the function of the zero point hysteresis to suppress this drifting.

With parameter CP.36 the analog signal for the input REF can be faded out in the range of 0...±10%. The adjusted value is valid for both directions of rotation.

If a negative percentage value is adjusted then the hysteresis is not only effective on the zero point but also around the actual set value. Set value changes are accepted only when they are larger than the adjusted hysteresis.

Adjustment range: -10,0...10,0 %
 Resolution: 0,1 %
 Factory setting: 0,2 %

1. Introduction		
2. Summary		
3. Hardware		
4. Operation	<ul style="list-style-type: none"> 4.1 Fundamentals 4.2 Password Structure 4.3 CP-Parameter 4.4 Drive-Mode 	<ul style="list-style-type: none"> 4.4.1 Adjustment Possibilities 3 4.4.2 Display and Keyboard 3 4.4.3 Setpoint Display / Setpoint Input 3 4.4.4 Rotation Setting 4 4.4.5 Start / Stop / Run 4 4.4.6 Leaving the Drive-Mode 5 4.4.7 Further Settings 5
5. Parameter		
6. Functions		
7. Start-up		
8. Special Operation		
9. Error Assistance		
10. Project Planning		
11. Networks		
12. Annex		

Chapter 4	Section 4	Page 2	Date 07.01.02	Name: Basis KEB COMBIVERT F5-G / B	© KEB Antriebstechnik, 2002 All Rights reserved
---------------------	---------------------	------------------	------------------	--	--

4.4 Drive-Mode

The Drive-Mode is a special operating mode of the KEB COMBIVERT. It allows an easy manual start-up. To activate the Drive-Mode enter the password „500“ in ‘CP.0’ or ‘ud.1’. Following settings are possible:

4.4.1 Adjustment Possibilities

- Stop / Start / Run
- Setpoint value
- Direction of rotation

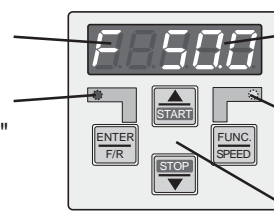
All other settings like setpoint limitation, acceleration time, deceleration time etc. correspond to the preselection in the parameter sets.

! Hardware condition: The control release must be bridged!

4.4.2 Display and Keyboard

Rotation display

Interface check
Transmission "LED on"



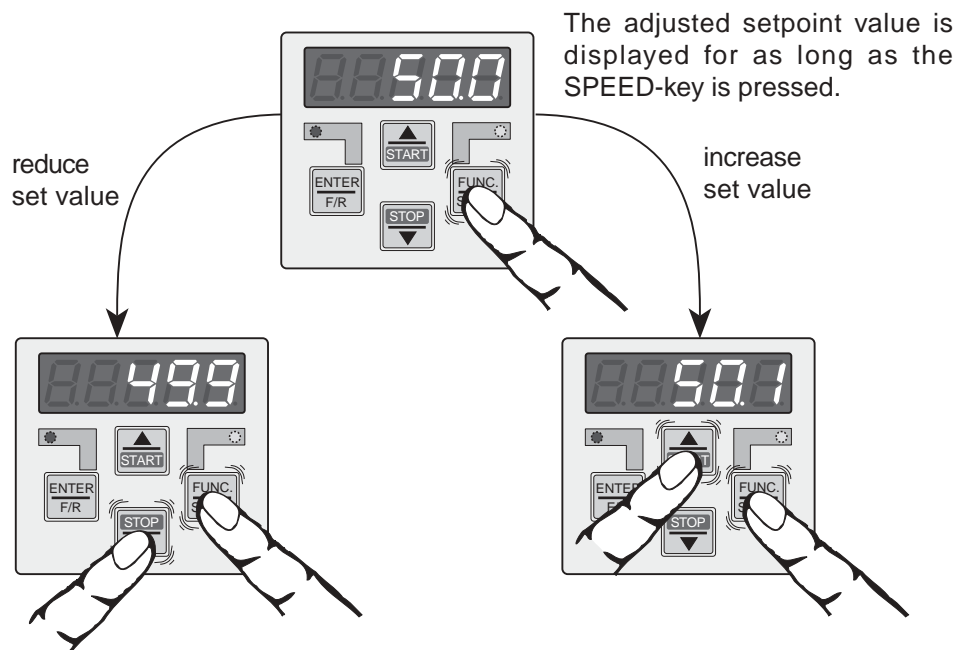
Display operating status / actual speed / setpoint speed

Status-/ Error display
Normal "LED on"
Error "LED blinking"

Operator panel

4.4.3 Setpoint Display / Setpoint Input

i The actual set value could be read by bus at Sy.45.



Press the SPEED-key and reduce the displayed setpoint value with the DOWN-key.

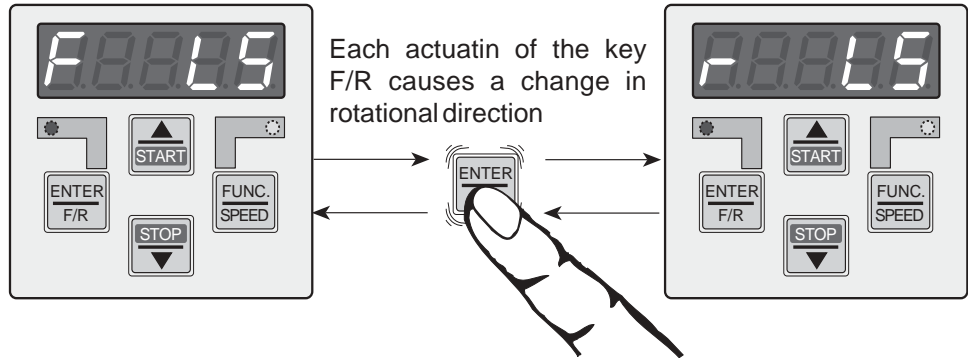
Press the SPEED-key and increase the displayed setpoint value with the UP-key.

i The setpoint entry via keyboard is possible only for parameter ud.9 = 0 (see 4.4.7).

4.4.4 Rotation Setting

Setting possibilities:

- F** = forward (clockwise rotation)
- r** = reverse (counter-clockwise rotation)

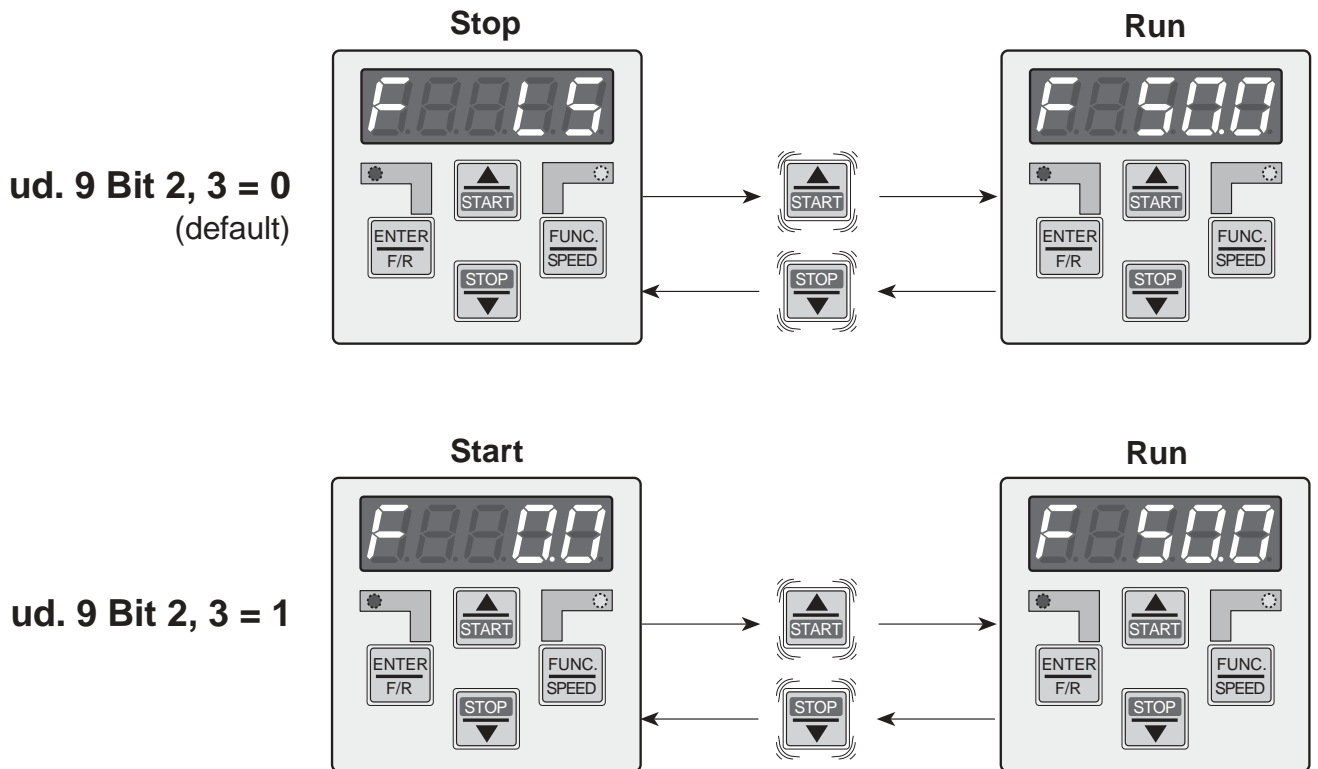


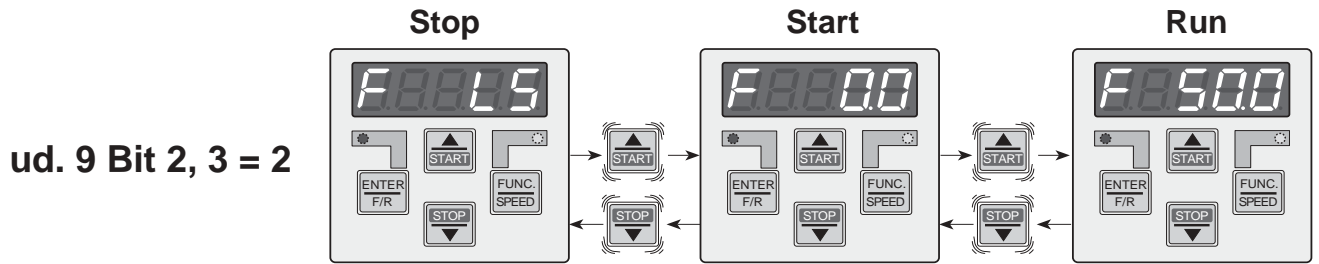
4.4.5 Start / Stop / Run

3 operating states exist in the Drive-Mode:

<p>Status „Stop“ Power module disconnected, drive is freewheeling (e.g. „F LS“)</p>	<p>Status „Start“ Powermodule is controlled with 0 Hz, drive stands with holding torque (e.g. „F 0.0“)</p>	<p>Status „Run“ The drive runs with preselected frequency (e.g. „F 50.0“)</p>
--	---	--

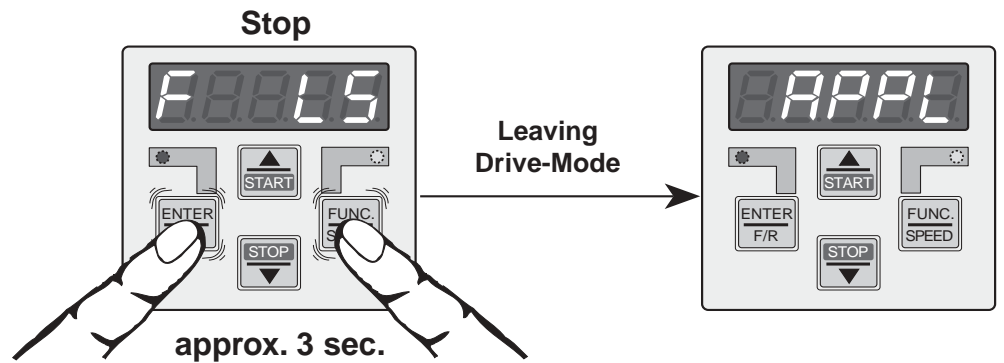
Bit 2 and 3 of the parameter ud.9 determines in what way the keys START and STOP approach the individual operating states:





4.4.6 Leaving the Drive-Mode

To leave the Drive-Mode, the keys „FUNC“ and „ENTER“ must be pressed simultaneously for approx. 3 seconds while being in status „Stop“. The unit jumps back into the mode from where the Drive-Mode was started.



4.4.7 Further Settings

With the Drive-Mode operating mode (ud.9) the setpoint sources and the conditions at starting/stopping can be specified. As setpoint source serves either the keyboard in the Drive-Mode as described under 4.4.3 or the setpoint source selected under parameter oP.0. Refer to 4.4.5 to learn about the different operating conditions at starting / stopping.

The status at starting / stopping (Bit 2 and 3) are only accepted after a restart the drive mode !

Bit 3	Bit 2	Bit 1	Bit 0	Function ud.9
x	x	x	0	Set value setting by keyboard
x	x	x	1	Set value setting by set value source oP.0
x	x	0	x	set value is 0-limited (negativ values = 0)
x	x	1	x	absolut set value settings
0	0	x	x	LS => run
0	1	x	x	0 Hz => run
1	0	x	x	LS => 0 Hz => run
1	1	x	x	reserved



To avoid undefined conditions, it must be ensured that the minimum frequency (oP.6, oP.7) is set to 0 Hz at the values ud.9 Bit 2, 3 = 1 or 2.

- 1. Introduction
- 2. Summary
- 3. Hardware
- 4. Operation
- 5. Parameter**
- 6. Functions
- 7. Start-up
- 8. Special Operation
- 9. Error Assistance
- 10. Project Planning
- 11. Networks
- 12. Annex

5.1 Parameter

- 5.1.1 Parameter Groups 3
- 5.1.2 F5-BASIC Control 4
- 5.1.3 F5-GENERAL Control
B-housing 4
- 5.1.4 F5-GENERAL Control
>= D-housing 5
- 5.1.5 Parameter Listing F5-G 7

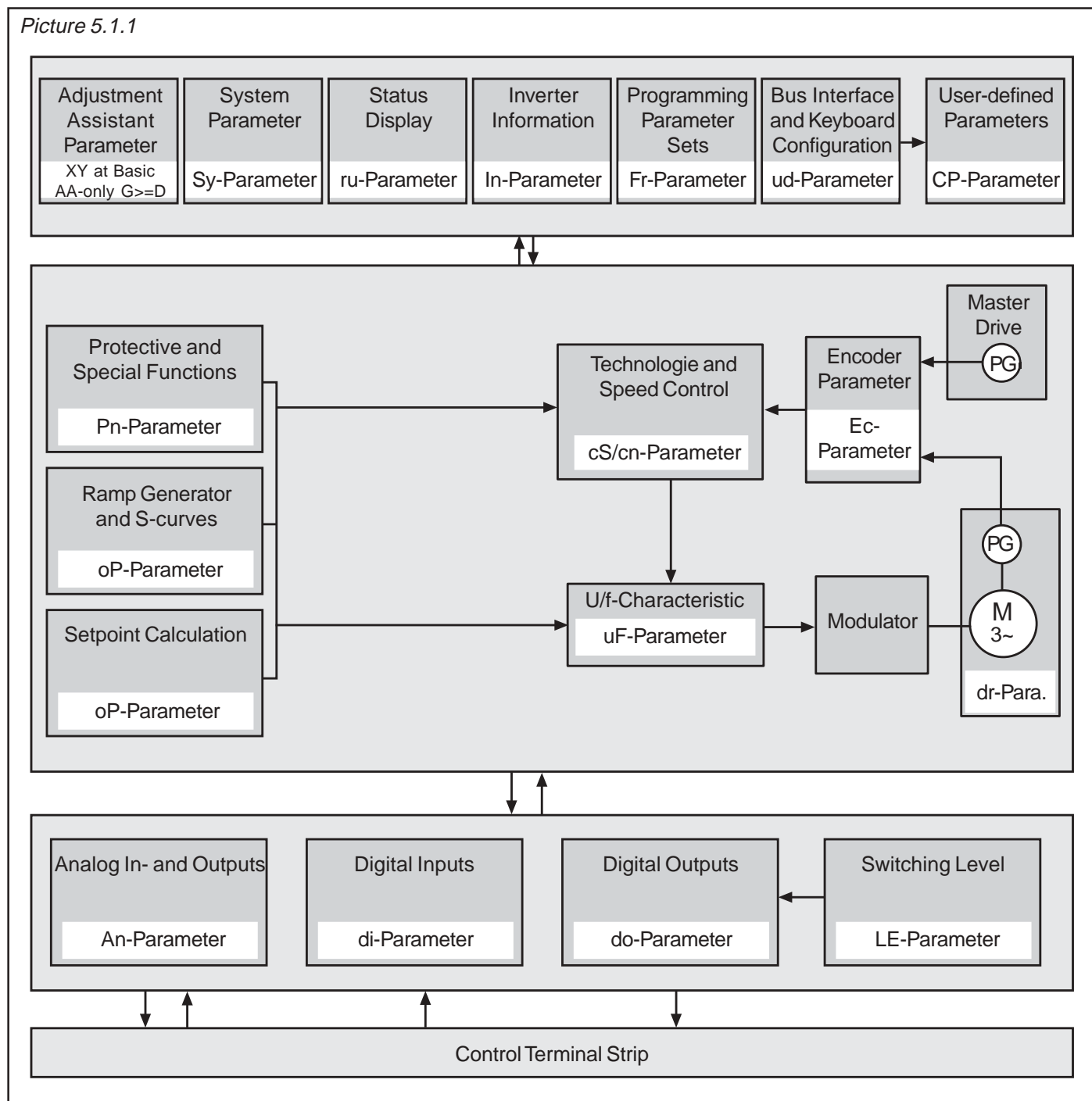
5. Parameter

5.1 Parameter

5.1.1 Parameter Groups

The frequency inverters KEB COMBIVERT F5-GENERAL and F5-BASIC contains 16 ($\geq D$ =housing 17) fixed, one free-to-define parameter group. We have already learned about the free-to-define group (CP). In the fixed parameter groups the parameters are combined function-related.

Picture 5.1.1



5.1.2 F5-BASIC Control

This control card is used for all housing sizes. Following parameters are not available with the control F5-BASIC, so they do not need to be considered in the parameter description:

ru 4	encoder 1 frequency	an29	AN3 upper limit
ru 5	encoder 2 frequency	an36	ANOUT2 function
ru 6	calculated act. freq.	an37	ANOUT2 value
ru 7	actual value display	an38	ANOUT2 gain
ru 9	encoder 1 speed	an39	ANOUT2 offset X
ru 10	encoder 2 speed	an40	ANOUT2 offset Y
ru 29	AN2 pre amplifier disp.	di 0	PNP / NPN selection
ru 30	AN2 post amplifier disp.	do25	inv. flags for O1
ru 31	AN3 pre amplifier disp.	do26	inv. flags for O2
ru 32	AN3 post amplifier disp.	do33	flag select. for O1
ru 35	ANOUT2 pre ampl. disp.	do34	flag select. for O2
ru 36	ANOUT2 post ampl. disp.	in 8	software version p. unit
an10	AN2 interface selection	in 9	software date p. unit
an11	AN2 noise filter		
an12	AN2 save mode		
an13	AN2 save trig. inp. sel.		
an14	AN2 zero clamp		
an15	AN2 gain		
an16	AN2 offset X		
an17	AN2 offset Y		
an18	AN2 lower limit		
an19	AN2 upper limit		
an20	AN3 interface selection		
an21	AN3 noise filter		
an22	AN3 save mode		
an23	AN3 save trig. inp. sel.		
an24	AN3 zero clamp		
an25	AN3 gain		
an26	AN3 offset X		
an27	AN3 offset Y		
an28	AN3 lower limit		

5.1.3 F5-GENERAL Control B-housing

This control card is used for housing size B. The parameters In.8 and In.9 are only available at this control card. The following parameters are not available, so they do not need to be considered in the parameter description:

ru 4	encoder 1 frequency	ec 3	time 1 for speed calc.
ru 5	encoder 2 frequency	ec 4	gear 1 numerator
ru 6	calculated act. freq.	ec 5	gear 1 determinant
ru 7	actual value display	ec 6	enc.1 rotation
ru 9	encoder 1 speed	ec 7	enc.1 trigger
ru 10	encoder 2 speed	ec10	encoder 2 interface
ru 31	AN3 pre amplifier disp.	ec11	encoder 2 (inc/r)
ru 32	AN3 post amplifier disp.	ec13	time 2 for speed calc.
op44	ext. funct. mode/src	ec14	gear 2 numerator
op45	ext. funct. dig. source	ec15	gear 2 determinant
op46	ext. funct. acc/dec time	ec16	enc.2 rotation
op47	sweep-gen. acc. time	ec17	enc.2 trigger
op48	sweep-gen. dec. time	ec20	enc.2 operating mode
op49	diam. corr. dmin/dmax	ec21	SSI multiturn res.
op51	motorpoti destination	ec22	SSI clock frq. sel.
an20	AN3 interface selection	ec23	SSI data code
an21	AN3 noise filter	ec25	nominal tach. speed
an22	AN3 save mode	ec27	operation mode output
an23	AN3 save trig. inp. sel.	aa14	evaluation para 1
an24	AN3 zero clamp	aa15	evaluation para 2
an25	AN3 gain	aa16	evaluation para 3
an26	AN3 offset X	aa17	evaluation para 4
an27	AN3 offset Y	aa18	evaluation para 5
an28	AN3 lower limit	aa19	evaluation para 6
an29	AN3 upper limit	aa20	evaluation para 7
in 5	interface type	aa21	evaluation para 8
in 17	temp.- mode	aa22	evaluation para 9
cs 1	act. source	aa23	evaluation para 10
dr 3	DASM rated power	aa24	evaluation para 11
ec 0	encoder 1 interface	aa25	evaluation para 12
ec 1	encoder 1 (inc/r)		

5.1.4 F5-GENERAL Control \geq D- housing

This control card is used for housing size D and upwards. The control comprises the entire parameters (except In.8 / In.9 and ud.5) and functions, that are described in this instruction manual.

5.1.5 Parameter Listing

Legend

Parameter: Parameter group, number and name
Adr.: Parameter address
Control: shows on in which control the appropriate parameter is present
 B => F5-Basic; g => F5-General ; G => F5-General >= D-housing;
 M => F5-Multi, S => F5-Servo; A => F5-Servo at A-housing
Properties: R => read only; P => programmable; E => Enter parameter; V => variable resolution (dep. on ud.2)
min.: Min. value (normalized); the non-normalized value results on division by the step range
max.: Max. value (normalized); the non-normalized value results on division by the step range
Step: Step range
default: Default value (normalized); the non-normalized value results on division by the step range
[?]: Unit of measure
See on page: Additional informations for this parameter on page ... (not chapter)

Parameter	Adr.	Control	Properties	min.	max.	Step	default	[?]	See on page
an 0 AN1 interface selection	0A00	B g G M S A	- - E -	0	2	1	0	-	6.2.4
an 1 AN1 noise filter	0A01	B g G M S A	- - E -	0	4	1	0	-	6.2.5
an 2 AN1 save mode	0A02	B g G M S A	- - E -	0	3	1	0	-	6.2.5
an 3 AN1 save trig. inp. sel.	0A03	B g G M S A	- - E -	0	4095	1	0	-	6.2.5
an 4 AN1 zero clamp	0A04	B g G M S A	- - - -	-10,0	10,0	0,1	0,2	%	6.2.6
an 5 AN1 gain	0A05	B g G M S A	- P - -	-20,00	20,00	0,01	1,00	-	6.2.7
an 6 AN1 offset X	0A06	B g G M S A	- P - -	-100,0	100,0	0,1	0,0	%	6.2.7
an 7 AN1 offset Y	0A07	B g G M S A	- P - -	-100,0	100,0	0,1	0,0	%	6.2.7
an 8 AN1 lower limit	0A08	B g G M S A	- P - -	-400,0	400,0	0,1	-400,0	%	6.2.8
an 9 AN1 upper limit	0A09	B g G M S A	- P - -	-400,0	400,0	0,1	400,0	%	6.2.8
an10 AN2 interface selection	0A0A	- g G M S -	- - E -	0	2	1	0	-	6.2.4
an11 AN2 noise filter	0A0B	- g G M S -	- - E -	0	4	1	0	-	6.2.5
an12 AN2 save mode	0A0C	- g G M S -	- - E -	0	3	1	0	-	6.2.5
an13 AN2 save trig. inp. sel.	0A0D	- g G M S -	- - E -	0	4095	1	0	-	6.2.5
an14 AN2 zero clamp	0A0E	- g G M S -	- - - -	-10,0	10,0	0,1	0,2	%	6.2.6
an15 AN2 gain	0A0F	- g G M S -	- P - -	-20,00	20,00	0,01	1,00	-	6.2.7
an16 AN2 offset X	0A10	- g G M S -	- P - -	-100,0	100,0	0,1	0,0	%	6.2.7
an17 AN2 offset Y	0A11	- g G M S -	- P - -	-100,0	100,0	0,1	0,0	%	6.2.7
an18 AN2 lower limit	0A12	- g G - - -	- P - -	-400,0	400,0	0,1	-400,0	%	6.2.8
an19 AN2 upper limit	0A13	- g G M S -	- P - -	-400,0	400,0	0,1	400,0	%	6.2.8
an20 AN3 interface selection	0A14	- - G M S -	- - E -	0	1	1	0	-	6.2.4
an21 AN3 noise filter	0A15	- - G M S -	- - E -	0	4	1	0	-	6.2.5
an22 AN3 save mode	0A16	- - G M S -	- - E -	0	3	1	0	-	6.2.5
an23 AN3 save trig. inp. sel.	0A17	- - G M S -	- - E -	0	4095	1	0	-	6.2.5
an24 AN3 zero clamp	0A18	- - G M S -	- - - -	-10,0	10,0	0,1	0,0	%	6.2.6
an25 AN3 gain	0A19	- - G M S -	- P - -	-20,00	20,00	0,01	1,00	-	6.2.7
an26 AN3 offset X	0A1A	- - G M S -	- P - -	-100,0	100,0	0,1	0,0	%	6.2.7
an27 AN3 offset Y	0A1B	- - G M S -	- P - -	-100,0	100,0	0,1	0,0	%	6.2.7
an28 AN3 lower limit	0A1C	- - G M S -	- P - -	-400,0	400,0	0,1	-400,0	%	6.2.8
an29 AN3 upper limit	0A1D	- - G M S -	- P - -	-400,0	400,0	0,1	400,0	%	6.2.8
an30 sel.REF inp./AUX-funct.	0A1E	- - G M S A	- P E -	0	65535	1	2112	-	6.2.9
an30 sel.REF inp./AUX-funct.	0A1E	B g - - -	- P E -	0	1	1	1	-	6.2.9
an31 ANOUT1 function	0A1F	B g G M S A	- P E -	0	20	1	2	-	6.2.11
an32 ANOUT1 value	0A20	B g G M S A	- P - -	-100,0	100,0	0,1	0,0	%	6.2.13
an33 ANOUT1 gain	0A21	B g G M S A	- P - -	-20,00	20,00	0,01	1,00	-	6.2.12
an34 ANOUT1 offset X	0A22	B g G M S A	- P - -	-100,0	100,0	0,1	0,0	%	6.2.12
an35 ANOUT1 offset Y	0A23	B g G M S A	- P - -	-100,0	100,0	0,1	0,0	%	6.2.12
an36 ANOUT2 function	0A24	- g G M S -	- P E -	0	20	1	6	-	6.2.11
an37 ANOUT2 value	0A25	- g G M S -	- P - -	-100,0	100,0	0,1	0,0	%	6.2.13
an38 ANOUT2 gain	0A26	- g G M S -	- P - -	-20,00	20,00	0,01	1,00	-	6.2.12
an39 ANOUT2 offset X	0A27	- g G M S -	- P - -	-100,0	100,0	0,1	0,0	%	6.2.12
an40 ANOUT2 offset Y	0A28	- g G M S -	- P - -	-100,0	100,0	0,1	0,0	%	6.2.12
an41 ANOUT3 function	0A29	B g G M S -	- - E -	0	20	1	12	-	6.2.11
an42 ANOUT3 value	0A2A	B g G M S -	- - - -	-100,0	100,0	0,1	0,0	%	6.2.13
an43 ANOUT3 gain	0A2B	B g G M S -	- - - -	-20,00	20,00	0,01	1,00	-	6.2.12
an44 ANOUT3 offset X	0A2C	B g G M S -	- - - -	-100,0	100,0	0,1	0,0	%	6.2.12
an45 ANOUT3 offset Y	0A2D	B g G M S -	- - - -	-100,0	100,0	0,1	0,0	%	6.2.12
an46 ANOUT3 period	0A2E	B g G M S -	- - E -	0	240	1	0	s	6.2.13
an47 ANOUT4 function	0A2F	- - G M S -	- - E -	0	20	1	12	-	6.2.11
an48 ANOUT4 value	0A30	- - G M S -	- - - -	-100,0	100,0	0,1	0,0	%	6.2.13
an49 ANOUT4 gain	0A31	- - G M S -	- - - -	-20,00	20,00	0,01	1,00	-	6.2.12
an50 ANOUT4 offset X	0A32	- - G M S -	- - - -	-100,0	100,0	0,1	0,0	%	6.2.12
an51 ANOUT4 offset Y	0A33	- - G M S -	- - - -	-100,0	100,0	0,1	0,0	%	6.2.12
an52 ANOUT4 period	0A34	- - G M S -	- - E -	0	240	1	0	s	6.2.13
an53 analog para setting mode	0A35	- - G M S A	- - E -	0	1	1	0	-	6.9.34

Parameter

Parameter	Adr.	Control	Properties	min.	max.	Step	default	[?]	see on Page
an54 an. para setting dest.	0A36	- - G M S A	- - E -	-1	7FFFH	1	-1	hex	6.9.34
an55 an. para setting offset	0A37	- - G M S A	- - - -	-2^31	2^31-1	1	0	-	6.9.34
an56 an. para set. max. value	0A38	- - G M S A	- - - -	-2^31	2^31-1	1	0	-	6.9.34
cn 0 PID reference source	0700	B g G M S A	- P - -	0	4	1	0	-	6.12.5
cn 1 PID abs. reference	0701	B g G M S A	- P - -	-400,0	400,0	0,1	0,0	%	6.12.5
cn 2 PID act. value src.	0702	B g G M S A	- P - -	0	7	1	0	-	6.12.6
cn 3 PID abs. act. value	0703	B g G M S A	- - - -	-400,0	400,0	0,1	0,0	%	6.12.6
cn 4 PID kp	0704	B g G M S A	- P - -	0,00	250,00	0,01	0,00	-	6.12.3
cn 5 PID ki	0705	B g G M S A	- P - -	0,000	30,000	0,001	0,000	-	6.12.3
cn 6 PID kd	0706	B g G M S A	- P - -	0,00	250,00	0,01	0,00	-	6.12.3
cn 7 PID pos. limit	0707	B g G M S A	- P - -	-400,0	400,0	0,1	400,0	%	6.12.3
cn 8 PID neg. limit	0708	B g G M S A	- P - -	-400,0	400,0	0,1	-400,0	%	6.12.3
cn 9 PID fading time	0709	B g G M S A	- P - -	-0,01	300,00	0,01	0,00	s	6.12.3
cn10 PID reset condition	070A	B g G M S A	- P - -	0	2	1	0	-	6.12.4
cn11 PID reset inp. sel.	070B	B g G M S A	- E - -	0	4095	1	0	-	6.12.4, 6.3.8
cn12 I reset inp. sel.	070C	B g G M S A	- E - -	0	4095	1	0	-	6.12.4, 6.3.8
cn13 fade in reset inp. sel.	070D	B g G M S A	- E - -	0	4095	1	0	-	6.12.4, 6.3.8
cn14 PID out freq at 100%	070E	B g G - - A - P - V	- - - -	-400	400	0,0125	0	Hz	6.12.4
cs 0 speed control config.	0F00	B g G - - - - P - - -	- - - -	0	63	1	0	-	6.6.11
cs 1 act. source	0F01	- - G - - - - P - - -	- - - -	0	2	1	2	-	6.6.14; 6.11.3, 6.11.13, 6.9.20
cs 4 speed ctrl. freq. limit	0F04	B g G - - A - P - V	- - - -	0	200	0,0125	25	Hz	
cs 6 KP speed	0F06	B g G - - A - P - - -	- - - -	0	32767	1	50	-	6.6.14
cs 9 KI speed	0F09	B g G - - A - P - - -	- - - -	0	32767	1	500	-	6.6.14
di 0 PNP / NPN selection	0B00	- g G M S A	- E - -	0	SHR	1	0	-	6.3.3
di 1 select signal source	0B01	B g G M S A	- E - -	0	4095	1	0	-	6.3.4
di 2 digital input setting	0B02	B g G M S A	- E - -	0	4095	1	0	-	6.3.4
di 3 digital noise filter	0B03	B g G M S A	- E - -	0	127	1	0	ms	6.3.5
di 4 input logic	0B04	B g G M S A	- E - -	0	4095	1	0	-	6.3.5
di 5 input trigger	0B05	B g G M S A	- E - -	0	4095	1	0	-	6.3.5
di 6 select strobe source	0B06	B g G M S A	- E - -	0	4095	1	0	-	6.3.6
di 7 strobe mode	0B07	B g G M S A	- E - -	0	2	1	0	-	6.3.7
di 8 input strobe dependence	0B08	B g G M S A	- E - -	0	4095	1	0	-	6.3.6
di 9 reset input selection	0B09	B g G M S A	- E - -	0	4095	1	3	-	6.3.8
di 10 reset input slope sel.	0B0A	B g G M S A	- E - -	0	4095	1	3	-	6.3.8
di 11 I1 functions	0B0B	B g G M S A	- E - -	0	H'3FFFFFFF	1	1	hex	6.3.9
di 12 I2 functions	0B0C	B g G M S A	- E - -	0	H'3FFFFFFF	1	2	hex	6.3.9
di 13 I3 functions	0B0D	B g G M S A	- E - -	0	H'3FFFFFFF	1	8192	hex	6.3.9
di 14 I4 functions	0B0E	B g G - - - - E - - -	- - - -	0	H'3FFFFFFF	1	512	hex	6.3.9
di 15 IA functions	0B0F	B g G M S A	- E - -	0	H'3FFFFFFF	1	0	hex	6.3.9
di 16 IB functions	0B10	B g G M S A	- E - -	0	H'3FFFFFFF	1	0	hex	6.3.9
di 17 IC functions	0B11	B g G M S A	- E - -	0	H'3FFFFFFF	1	0	hex	6.3.9
di 18 ID functions	0B12	B g G M S A	- E - -	0	H'3FFFFFFF	1	0	hex	6.3.9
di 19 F functions	0B13	B g G M S - - - E - -	- - - -	0	H'3FFFFFFF	1	32	hex	6.3.9
di 20 R functions	0B14	B g G M S - - - E - -	- - - -	0	H'3FFFFFFF	1	64	hex	6.3.9
di 21 RST functions	0B15	B g G M S - - - E - -	- - - -	0	H'3FFFFFFF	1	128	hex	6.3.9
di 22 ST functions	0B16	B g G M S A	- E - -	0	H'3FFFFFFF	1	128	hex	6.3.9
do 0 condition 0	0C00	B g G M S A	- P E -	0	68	1	20	-	6.3.13
do 1 condition 1	0C01	B g G M S A	- P E -	0	68	1	3	-	6.3.13
do 2 condition 2	0C02	B g G M S A	- P E -	0	68	1	4	-	6.3.13
do 3 condition 3	0C03	B g G - - - - P E - -	- - - -	0	68	1	27	-	6.3.13
do 4 condition 4	0C04	B g G M S A	- P E -	0	68	1	0	-	6.3.13
do 5 condition 5	0C05	B g G M S A	- P E -	0	68	1	0	-	6.3.13
do 6 condition 6	0C06	B g G M S A	- P E -	0	68	1	0	-	6.3.13
do 7 condition 7	0C07	B g G M S A	- P E -	0	68	1	0	-	6.3.13
do 8 inv. cond. for flag 0	0C08	B g G M S A	- P E -	0	255	1	0	-	6.3.16
do 9 inv. cond. for flag 1	0C09	B g G M S A	- P E -	0	255	1	0	-	6.3.16
do 10 inv. cond. for flag 2	0C0A	B g G M S A	- P E -	0	255	1	0	-	6.3.16
do 11 inv. cond. for flag 3	0C0B	B g G M S A	- P E -	0	255	1	0	-	6.3.16
do 12 inv. cond. for flag 4	0C0C	B g G M S A	- P E -	0	255	1	0	-	6.3.16
do 13 inv. cond. for flag 5	0C0D	B g G M S A	- P E -	0	255	1	0	-	6.3.16
do 14 inv. cond. for flag 6	0C0E	B g G M S A	- P E -	0	255	1	0	-	6.3.16
do 15 inv. cond. for flag 7	0C0F	B g G M S A	- P E -	0	255	1	0	-	6.3.16
do 16 cond. select. for flag 0	0C10	B g G M S A	- P E -	0	255	1	1	-	6.3.16
do 17 cond. select. for flag 1	0C11	B g G M S A	- P E -	0	255	1	2	-	6.3.16
do 18 cond. select. for flag 2	0C12	B g G M S A	- P E -	0	255	1	4	-	6.3.16
do 19 cond. select. for flag 3	0C13	B g G M S A	- P E -	0	255	1	8	-	6.3.16
do 20 cond. select. for flag 4	0C14	B g G M S A	- P E -	0	255	1	16	-	6.3.16
do 21 cond. select. for flag 5	0C15	B g G M S A	- P E -	0	255	1	32	-	6.3.16
do 22 cond. select. for flag 6	0C16	B g G M S A	- P E -	0	255	1	64	-	6.3.16
do 23 cond. select. for flag 7	0C17	B g G M S A	- P E -	0	255	1	128	-	6.3.16
do 24 AND conn. for flags	0C18	B g G M S A	- P E -	0	255	1	0	-	6.3.16
do 25 inv. flags for O1	0C19	- g G M S A	- P E -	0	255	1	0	-	6.3.17
do 26 inv. flags for O2	0C1A	- g G M S A	- P E -	0	255	1	0	-	6.3.17
do 27 inv. flags for R1	0C1B	B g G M S A	- P E -	0	255	1	0	-	6.3.17
do 28 inv. flags for R2	0C1C	B g G M S - - - P E -	- - - -	0	255	1	0	-	6.3.17
do 29 inv. flags for OA	0C1D	B g G M S A	- P E -	0	255	1	0	-	6.3.17
do 30 inv. flags for OB	0C1E	B g G M S A	- P E -	0	255	1	0	-	6.3.17

Parameter	Adr.	Control	Properties	min.	max.	Step	default	[?]	see on Page
do31 inv. flags for OC	0C1F	B g G M S A	- P E -	0	255	1	0	-	6.3.17
do32 inv. flags for OD	0C20	B g G M S A	- P E -	0	255	1	0	-	6.3.17
do33 flag select. for O1	0C21	- g G M S A	- P E -	0	255	1	1	-	6.3.17
do34 flag select. for O2	0C22	- g G M S A	- P E -	0	255	1	2	-	6.3.17
do35 flag select. for R1	0C23	B g G M S A	- P E -	0	255	1	4	-	6.3.17
do36 flag select. for R2	0C24	B g G M S A	- P E -	0	255	1	8	-	6.3.17
do37 flag select. for OA	0C25	B g G M S A	- P E -	0	255	1	16	-	6.3.17
do38 flag select. for OB	0C26	B g G M S A	- P E -	0	255	1	32	-	6.3.17
do39 flag select. for OC	0C27	B g G M S A	- P E -	0	255	1	64	-	6.3.17
do40 flag select. for OD	0C28	B g G M S A	- P E -	0	255	1	128	-	6.3.17
do41 AND conn. for outputs	0C29	B g G M S A	- P E -	0	255	1	0	-	6.3.17
do42 inverted outputs	0C2A	B g G M S A	- P E -	0	255	1	0	-	6.3.18
do43 cond. 0 filter time	0C2B	- - G M S A	- P -	0	1000	1	0	ms	6.3.12
do44 cond. 1 filter time	0C2C	- - G M S A	- P -	0	1000	1	0	ms	6.3.12
dr 0 DASM rated current	0600	B g G M - A	- P -	0,0	710	0,1	LTK	A	6.6.3
dr 1 DASM rated speed	0601	B g G M - A	- P -	0	64000	1	LTK	rpm	6.6.3
dr 2 DASM rated voltage	0602	B g G M - A	- P -	120	500	1	LTK	V	6.6.3
dr 3 DASM rated power	0603	- - G M - A	- P -	0,35	400,00	0,01	LTK	kW	6.6.3
dr 4 DASM rated cos(phi)	0604	B g G M - A	- P -	0,50	1,00	0,01	LTK	-	6.6.3
dr 5 DASM rated frequency	0605	B g G M - A	- P -	0,0	1600,0	0,1	LTK	Hz	6.6.3
dr 6 DASM stator resistance	0606	B g G M - A	- P -	0,000	50,000	0,001	LTK	Ohm	6.6.4
dr 9 breakdown factor	0609	B g G - - A	- P -	0,5	4,0	0,1	2,5	-	-
dr 11 motorprotection mode	060B	B g G M - A	- P -	0	1	1	1	-	6.7.16
dr 12 motorprot. rated current	060C	B g G M - A	- P -	0,0	710,0	0,1	LTK	A	6.7.16
ec 0 encoder 1 interface	1000	- - G M S A	- - X	-127	127	1	GBK	-	6.10.10
ec 1 encoder 1 (inc/r)	1001	- - G M S A	- - -	- GBK	GBK	1	GBK	inc	6.10.10
ec 3 time 1 for speed calc.	1003	- - G M S A	- - -	0	9	1	3	-	6.10.10
ec 4 gear 1 numerator	1004	- - G M S A	- - -	-10000	10000	1	1000	-	6.10.11
ec 5 gear 1 determinator	1005	- - G M S A	- - -	1	10000	1	1000	-	6.10.11
ec 6 enc.1 rotation	1006	- - G M S A	- - -	0	19	1	0	-	6.10.11
ec 7 enc.1 trigger	1007	- - G M S A	- - -	- GBK	GBK	1	GBK	-	6.10.11
ec10 encoder 2 interface	100A	- - G M S A	- - X	-127	127	1	GBK	-	6.10.6, 6.10.10
ec11 encoder 2 (inc/r)	100B	- - G M S A	- - -	- GBK	GBK	1	GBK	inc	6.10.10
ec13 time 2 for speed calc.	100D	- - G M S A	- - -	0	9	1	3	-	6.10.10
ec14 gear 2 numerator	100E	- - G M S A	- - -	-10000	10000	1	1000	-	6.10.11
ec15 gear 2 determinator	100F	- - G M S A	- - -	1	10000	1	1000	-	6.10.11
ec16 enc.2 rotation	1010	- - G M S A	- - -	0	19	1	0	-	6.10.11
ec17 enc.2 trigger	1011	- - G M S A	- - -	- GBK	GBK	1	GBK	-	6.10.11
ec20 enc.2 operating mode	1014	- - G M S A	- - -	0	1	1	0	-	6.10.7
ec21 SSI multturn res.	1015	- - G M S -	- - -	0	13	1	12	-	6.10.13
ec22 SSI clock frq. sel.	1016	- - G M S -	- - -	0	1	1	0	-	6.10.13
ec23 SSI data code	1017	- - G M S -	- - -	0	1	1	1	-	6.10.13
ec25 nominal tach. speed	1019	- - G M S -	- - -	1	16000	1	1500	rpm	6.10.13
ec27 operation mode output	101A	- - G M S -	- - E	0	47	1	0	-	6.10.12
ec31 abs. position ch1	101F	- - G M S A	- - -	-2^31	2^31-1	1	0	inc	6.10.13
ec32 abs. position ch2	1020	- - G M S A	- - -	-2^31	2^31-1	1	0	inc	6.10.13
ec36 enc.1 encoder type	1024	- - G M S -	- - -	0	255	1	0	-	6.10.13
ec37 enc.1 encoder status	1025	- - G M S -	- - -	0	255	1	0	-	6.10.13
ec38 enc.1 encoder r/w	1026	- - G M S -	- - E	0	2	1	0	-	6.10.13
fr 1 copy parameter set	0901	B g G M S A	- P E -	-4	7	1	0	-	6.8.4
fr 2 parameter set source	0902	B g G M S A	- E -	0	5	1	0	-	6.8.5
fr 3 parameter set lock	0903	B g G M S A	- E -	0	255	1	0	-	6.8.8
fr 4 parameter set setting	0904	B g G M S A	- E -	0	7	1	0	-	6.8.5
fr 5 set activation delay	0905	B g G M S A	- P -	0,00	2,55	0,01	0,00	s	6.8.8, 6.9.31
fr 6 set deactivation delay	0906	B g G M S A	- P -	0,00	2,55	0,01	0,00	s	6.8.8, 6.9.31
fr 7 paraset input sel.	0907	B g G M S A	- E -	0	4095	1	0	-	6.8.6, 6.3.8
fr 8 motor set classification	0908	B g G M - A	- P -	0	7	1	0	-	6.7.14
fr 9 bus parameter set	0909	B g G M S A	- - -	-1	7	1	0	-	6.8.4
fr 10 load mot.dependent para.	090A	- - G - - -	- P E -	3	3	1	0	-	6.6.6
fr 11 reset set input sel.	090B	B g G M S A	- E -	0	4095	1	0	-	6.8.7, 6.3.8
in 0 inverter type	0E00	B g G M S A	R - -	- LTK	LTK	1	LTK	hex	6.1.19
in 1 rated inverter current	0E01	B g G M S A	R - -	- LTK	LTK	0,1	LTK	A	6.1.19
in 3 max. carrier frequency	0E03	B g G M S A	R - -	- LTK	LTK	1	LTK	-	6.1.20
in 4 rated carrier frequency	0E04	B g G M S A	R - -	- LTK	LTK	1	LTK	-	6.1.20
in 6 software version	0E06	B g G M S A	R - -	- SW	SW	0,01	SW	-	6.1.20
in 7 software date	0E07	B g G M S A	R - -	- SW	SW	0,1	SW	-	6.1.20
in 8 software version p. unit	0E08	- g - - - R	- - -	- LTK	LTK	1	LTK	-	-
in 9 software date p. unit	0E09	- g - - - R	- - -	- LTK	LTK	1	LTK	-	-
in 10 serial no. (date)	0E0A	B g G M S A	R - -	0	65535	1	0	-	6.1.21
in 11 serial no. (count)	0E0B	B g G M S A	R - -	0	65535	1	0	-	6.1.21
in 12 serial no. (AB-no. high)	0E0C	B g G M S A	R - -	0	65535	1	0	-	6.1.21
in 13 serial no. (AB-no. low)	0E0D	B g G M S A	R - -	0	65535	1	0	-	6.1.21
in 14 customer no. high	0E0E	B g G M S A	R - -	0	65535	1	0	-	6.1.21
in 15 customer no. low	0E0F	B g G M S A	R - -	0	65535	1	0	-	6.1.21
in 16 QS no.	0E10	B g G M S A	R - -	0	65535	1	0	-	6.1.21
in 17 temp.- mode	0E11	- - G M S A	R - -	- LTK	LTK	1	LTK	-	6.1.21
in 22 user parameter 1	0E16	B g G M S A	- - -	0	65535	1	0	-	6.1.21

Parameter

Parameter	Adr.	Control	Properties	min.	max.	Step	default	[?]	see on Page
in 23 user parameter 2	0E17	B g G M S A	- - -	0	65535	1	0	-	6.1.21
in 24 last error	0E18	B g G M S A R	- E -	0	255	-	0	-	6.1.21
in 25 error diagnosis	0E19	B g G M S A R P	- - -	0	65535	1	0	hex	6.1.22
in 26 E.OC error counter	0E1A	B g G M S A R	- - -	0	65535	1	0	-	6.1.22
in 27 E.OL error counter	0E1B	B g G M S A R	- - -	0	65535	1	0	-	6.1.22
in 28 E.OP error counter	0E1C	B g G M S A R	- - -	0	65535	1	0	-	6.1.22
in 29 E.OH error counter	0E1D	B g G M S A R	- - -	0	65535	1	0	-	6.1.22
in 30 E.OHI error counter	0E1E	B g G M S A R	- - -	0	65535	1	0	-	6.1.22
le 0 comparison level 0	0D00	B g G - - -	- P -	-30000,00	30000,00	0,01	0,00	-	6.3.15, 6.9.13
le 1 comparison level 1	0D01	B g G - - -	- P -	-30000,00	30000,00	0,01	0,00	-	6.3.15, 6.9.13
le 2 comparison level 2	0D02	B g G - - -	- P -	-30000,00	30000,00	0,01	100,00	-	6.3.15, 6.9.13
le 3 comparison level 3	0D03	B g G - - -	- P -	-30000,00	30000,00	0,01	4,00	-	6.3.15, 6.9.13
le 4 comparison level 4	0D04	B g G - - -	- P -	-30000,00	30000,00	0,01	0,00	-	6.3.15, 6.9.13
le 5 comparison level 5	0D05	B g G - - -	- P -	-30000,00	30000,00	0,01	0,00	-	6.3.15, 6.9.13
le 6 comparison level 6	0D06	B g G - - -	- P -	-30000,00	30000,00	0,01	0,00	-	6.3.15, 6.9.13
le 7 comparison level 7	0D07	B g G - - -	- P -	-30000,00	30000,00	0,01	0,00	-	6.3.15, 6.9.13
le 8 hysteresis 0	0D08	B g G M S A	- P -	0,00	300,00	0,01	0,00	-	6.3.15
le 9 hysteresis 1	0D09	B g G M S A	- P -	0,00	300,00	0,01	0,00	-	6.3.15
le 10 hysteresis 2	0D0A	B g G M S A	- P -	0,00	300,00	0,01	5,00	-	6.3.15
le 11 hysteresis 3	0D0B	B g G M S A	- P -	0,00	300,00	0,01	0,50	-	6.3.15
le 12 hysteresis 4	0D0C	B g G M S A	- P -	0,00	300,00	0,01	0,00	-	6.3.15
le 13 hysteresis 5	0D0D	B g G M S A	- P -	0,00	300,00	0,01	0,00	-	6.3.15
le 14 hysteresis 6	0D0E	B g G M S A	- P -	0,00	300,00	0,01	0,00	-	6.3.15
le 15 hysteresis 7	0D0F	B g G M S A	- P -	0,00	300,00	0,01	0,00	-	6.3.15
le 16 freq/speed hysteresis	0D10	B g G - - -	- - V	0	20	0,0125	0,8	Hz	6.3.15
le 17 timer 1 start inp. sel.	0D11	B g G M S A	- E -	0	4095	1	0	-	6.3.8, 6.9.12
le 18 timer 1 start condition	0D12	B g G M S A	- E -	0	7	1	0	-	6.3.8, 6.9.12
le 19 timer 1 reset inp. sel.	0D13	B g G M S A	- E -	0	4095	1	0	-	6.3.8, 6.9.12
le 20 timer 1 reset condition	0D14	B g G M S A	- E -	0	31	1	16	-	6.9.13
le 21 timer 1 mode	0D15	B g G M S A	- - -	0	31	1	0	-	6.9.11
le 22 timer 2 start inp. sel.	0D16	B g G M S A	- E -	0	4095	1	0	-	6.3.8, 6.9.12
le 23 timer 2 start condition	0D17	B g G M S A	- E -	0	7	1	0	-	6.3.8, 6.9.12
le 24 timer 2 reset inp. sel.	0D18	B g G M S A	- E -	0	4095	1	0	-	6.3.8, 6.9.12
le 25 timer 2 reset condition	0D19	B g G M S A	- E -	0	31	1	16	-	6.9.13
le 26 timer 2 mode	0D1A	B g G M S A	- - -	0	31	1	0	-	6.9.11
op 0 reference source	0300	B g - - -	- P E -	0	5	1	0	-	6.4.4, 6.9.9
op 0 reference source	0300	- - G M S A	- P E -	0	9	1	0	-	6.4.4, 6.9.9
op 1 rotation source	0301	B g G - - -	- P E -	0	9	1	2	-	6.4.6, 6.9.9
op 2 rotation setting	0302	B g G M S A	- P E -	0	2	1	0	-	6.4.6
op 3 reference setting	0303	B g G - - -	- P V	-400	400	0,0125	0	Hz	6.4.4
op 5 reference setting %	0305	B g G M S A	- P -	-100,0	100,0	0,1	0,0	%	6.4.4
op 6 min. reference forward	0306	B g G - - -	- P V	0	400	0,0125	0	Hz	6.4.11
op 7 min. reference reverse	0307	B g G - - -	- P V	-0,0125	400	0,0125	-0,0125	Hz	6.4.11
op 10 max. reference forward	030A	B g G - - -	- P V	0	400	0,0125	0	Hz	6.4.11
op 11 max. reference reverse	030B	B g G - - -	- P V	-0,0125	400	0,0125	-0,0125	Hz	6.4.11
op 14 abs. max. reference for	030E	B g G - - -	- P V	0	400	0,0125	400	Hz	6.4.11
op 15 abs. max. reference rev	030F	B g G - - -	- P V	-0,0125	400	0,0125	-0,0125	Hz	6.4.11
op 18 step value rot. source	0312	B g G - - -	- P E -	0	9	1	2	-	6.4.9
op 19 step value input sel. 1	0313	B g G M S A	- E -	0	4095	1	16	-	6.4.9, 6.3.8
op 20 step value input sel. 2	0314	B g G M S A	- E -	0	4095	1	32	-	6.4.9, 6.3.8
op 21 step value 1	0315	B g G - - -	- P V	-400	400	0,0125	5	Hz	6.4.9
op 22 step value 2	0316	B g G - - -	- P V	-400	400	0,0125	50	Hz	6.4.9
op 23 step value 3	0317	B g G - - -	- P V	-400	400	0,0125	70	Hz	6.4.9
op 27 acc dec mode	031B	B g G M S A	- P E -	0	255	1	0	-	6.4.16
op 28 acc. time forward	031C	B g G M S A	- P -	0,00	300,00	0,01	5,00	s	6.4.13
op 29 acc. time reverse	031D	B g G M S A	- P -	-0,01	300,00	0,01	-0,01	s	6.4.13
op 30 dec. time forward	031E	B g G M S A	- P -	-0,01	300,00	0,01	5,00	s	6.4.13
op 31 dec. time reverse	031F	B g G M S A	- P -	-0,01	300,00	0,01	-0,01	s	6.4.13
op 32 s-curve time acc. for.	0320	B g G M S A	- P -	0,00	5,00	0,01	0,00	s	6.4.14
op 33 s-curve time acc. rev.	0321	B g G M S A	- P -	-0,01	5,00	0,01	-0,01	s	6.4.14
op 34 s-curve time dec. for.	0322	B g G M S A	- P -	-0,01	5,00	0,01	-0,01	s	6.4.14
op 35 s-curve time dec. rev.	0323	B g G M S A	- P -	-0,01	5,00	0,01	-0,01	s	6.4.14
op 36 min. output freq. for	0324	B g G - - A	- P V	0	400	0,0125	0	Hz	
op 37 min. output freq. rev	0325	B g G - - A	- P V	-0,0125	400	0,0125	-0,0125	Hz	
op 40 max. output val. for.	0328	B g G - - -	- P V	0	400	0,0125	400	Hz	6.4.15, 6.7.5
op 41 max. output val. rev.	0329	B g G - - -	- P V	-0,0125	400	0,0125	-0,0125	Hz	6.4.15, 6.7.5
op 44 ext. funct. mode/src	032C	- - G M S A	- P E -	0	63	1	0	-	6.9.27, 6.9.29
op 45 ext. funct. dig. source	032D	- - G M S A	- P -	0,00	100,00	0,01	0,00	%	6.9.27, 6.9.29
op 46 ext. funct. acc/dec time	032E	- - G M S A	- P -	0,00	20,00	0,01	10,00	s	6.9.27, 6.9.30
op 47 sweep-gen. acc. time	032F	- - G M S A	- P -	0,00	20,00	0,01	10,00	s	6.9.27
op 48 sweep-gen. dec. time	0330	- - G M S A	- P -	0,00	20,00	0,01	10,00	s	6.9.27
op 49 diam. corr. dmin/dmax	0331	- - G M S A	- P -	-0,010	0,990	0,001	0,500	-	6.9.30
op 50 motorpoti function	0332	B g G M S A	- E -	0	3	1	0	-	6.9.8
op 52 motorpoti value	0334	B g G M S A	- P -	-100,00	100,00	0,01	0,00	%	6.9.9
op 53 motorpoti min. value	0335	B g G M S A	- - -	-100,00	100,00	0,01	0,00	%	6.9.8
op 54 motorpoti max. value	0336	B g G M S A	- - -	-100,00	100,00	0,01	100,00	%	6.9.8
op 55 motorpoti reset value	0337	B g G M S A	- - -	-100,00	100,00	0,01	0,00	%	6.9.7

Parameter	Adr.	Control	Properties	min.	max.	Step	default	[?]	see on Page
op56 mot.poti inc. input sel.	03 38	B g G M S A	- - E -	0	4095	1	0	-	6.3.8, 6.9.8
op57 mot.poti dec. input sel.	03 39	B g G M S A	- - E -	0	4095	1	0	-	6.9.8, 6.3.8
op58 mot.poti reset inp. sel.	03 3A	B g G M S A	- - E -	0	4095	1	0	-	6.9.8, 6.3.8
op59 motorpoti inc/dec time	03 3B	B g G M S A	- - - -	0,00	50000,00	0,01	66,00	s	6.9.8
op60 dir. forward input sel.	03 3C	B g G M S A	- - E -	0	4095	1	4	-	6.3.8, 6.4.7
op61 dir. reverse input sel.	03 3D	B g G M S A	- - E -	0	4095	1	8	-	6.3.8, 6.4.7
op62 acc/dec time factor	03 3E	B g G M S A	- - E -	0	4	1	0	-	6.4.13
pn 0 auto retry UP	04 00	B g G M S A	- - - -	0	1	1	1	-	6.7.7
pn 1 auto retry OP	04 01	B g G M S A	- - - -	0	1	1	0	-	6.7.7
pn 2 auto retry OC	04 02	B g G M S A	- - - -	0	1	1	0	-	6.7.7
pn 3 E. EF stopping mode	04 03	B g G M S A	- - - -	0	6	1	0	-	6.7.10
pn 4 ext. fault input select	04 04	B g G M S A	- - E -	0	4095	1	64	-	6.7.9, 6.3.8
pn 5 E.buS stopping mode	04 05	B g G M S A	- - - -	0	6	1	6	-	6.7.10, 11.2.3
pn 6 watchdog time	04 06	B g G M S A	- - E -	0,00:off	10,00	0,01	0,00:off	s	6.7.10, 11.2.3
pn 8 warning OL stop. mode	04 08	B g G M S A	- - - -	0	6	1	6	-	6.7.11, 6.3.15
pn 9 OL warning level	04 09	B g G M S A	- - - -	0	100	1	80	%	6.7.10
pn10 warning OH stop. mode	04 0A	B g G M S A	- - - -	0	6	1	6	-	6.7.11, 6.3.15
pn11 OH warning level	04 0B	B g G M S A	- - - -	0	90	1	70	°C	6.7.11
pn12 warning dOH stop. mode	04 0C	B g G - - -	- - - -	0	7	1	7	-	6.7.11, 6.3.15, 6.7.18
pn13 E.dOH delay time	04 0D	B g G - - -	- - - -	0	120	1	10	s	6.7.11, 6.7.18
pn14 warning OH2 stop. mode	04 0E	B g G M S A	- - - -	0	6	1	6	-	6.7.12, 6.7.17, 6.3.15
pn16 warning OHI stop. mode	04 10	B g G M S A	- - - -	0	7	1	7	-	6.7.12, 6.3.16
pn17 E.OHI delay time	04 11	B g G M S A	- - - -	0	120	1	0	s	6.7.12
pn18 E.Set stopping mode	04 12	B g G M S A	- - - -	0	6	1	0	-	6.7.12
pn19 stall mode	04 13	- - G M - -	- - P E	- 0	255	1	0	-	6.7.5
pn19 stall mode	04 13	B g - - - A	- - P E	- 0	127	1	0	-	6.7.5
pn20 stall level	04 14	B g G M - -	- - P -	- 0	200	1	200:off	%	6.7.6
pn21 stall acc/dec time	04 15	B g G M - -	- - P -	- 0	300,00	0,01	2,00	s	6.7.6
pn22 LAD stop function	04 16	B g G M S A	- - P E	- 0	7	1	1 / 0	-	6.7.3
pn23 LAD stop input selection	04 17	B g G M S A	- - E -	- 0	4095	1	0	-	6.7.3, 6.3.8
pn24 LAD load level	04 18	B g G M S A	- - P -	- 0	200	1	140	%	6.7.3
pn25 LD voltage	04 19	B g G M S A	- - P -	- 200	800	1	375 / 720	V	6.7.3
pn26 speed search condition	04 1A	B g G M - -	- - P E	- 0	15	1	8	-	6.7.7
pn27 speed search mode	04 1B	B g G M - -	- - E -	- 0	127	1	0/88	-	6.7.7
pn28 DC braking mode	04 1C	B g G M - -	- - P E	- 0	9	1	7	-	6.9.4
pn29 DC brake input selection	04 1D	B g G M - -	- - E -	- 0	4095	1	128	-	6.9.4, 6.3.8
pn30 DC braking time	04 1E	B g G M - -	- - P -	- 0,00	100,00	0,01	10,00	s	6.9.3
pn31 DC braking max. voltage	04 1F	B g G M - -	- - P -	- 0,0	25,5	0,1	25,5	%	6.9.3
pn32 DC braking start freq.	04 20	B g G - - -	- - P -	- V 0	400	0,0125	4	Hz	6.9.3
pn34 brake control mode	04 22	B g G M S A	- - P E	- 0	4	1	0	-	6.9.16
pn35 premagnetizing time	04 23	B g G M S A	- - P -	- 0,00	100,00	0,01	0,25	s	6.9.15
pn36 brake release time	04 24	B g G M S A	- - P -	- 0,00	100,00	0,01	0,25	s	6.9.15
pn37 brake ctrl. start ref.	04 25	B g G - - -	- - P -	- V -20	20	0,0125	0	Hz	6.9.17
pn39 brake delay time	04 27	B g G M S A	- - P -	- 0,00	100,00	0,01	0,25	s	6.9.15
pn40 brake closing time	04 28	B g G M S A	- - P -	- 0,00	100,00	0,01	0,25	s	6.9.15
pn41 brake ctrl. stop ref.	04 29	B g G M S A	- - P -	- V -20	20	0,0125	0	Hz	6.9.17
pn41 brake ctrl. stop ref.	04 29	B g G M S A	- - P -	- V -600	600	0,125	0	rpm	6.9.17
pn43 min. load brake ctrl.	04 2B	B g G M S A	- - P -	- 0	100	1	0	%	6.9.16
pn44 power off mode	04 2C	B g G M S A	- - E -	- 0	511	1	0	-	6.9.19, 6.9.20, 6.9.23
pn45 power off start voltage	04 2D	B g G M S A	- - - -	- 200	800	1	290 / 500	V	6.9.20, 6.9.21
pn46 power off auto st. level	04 2E	B g G M S A	- - - -	- 50	90	1	80	%	6.9.20, 6.9.21
pn47 power off brake torque	04 2F	B g G - - -	- - A -	- 0,0	100,0	0,1	0,0	%	6.9.21
pn48 power off restart level	04 30	B g G - - -	- - - V	- 0	400	0,0125	0	Hz	6.9.22
pn50 power off ref. DC volt.	04 32	B g G - - -	- - A -	- 200	800	1	290 / 500	V	6.9.21
pn51 power off KP DC volt.	04 33	B g G M - -	- - A -	- 0	32767	1	128	-	6.9.22
pn52 power off restart delay	04 34	B g G M S A	- - - -	- 0,00	100,00	0,01	0,00	s	6.9.23
pn53 power off KP act.curr.	04 35	B g G - - -	- - A -	- 0	32767	1	50	-	6.9.22
pn54 power off KI act.curr.	04 36	B g G - - -	- - A -	- 0	32767	1	50	-	6.9.22
pn55 power off KD act.curr.	04 37	B g G - - -	- - A -	- 0	32767	1	0	-	6.9.22
pn56 power off jump factor	04 38	B g G - - -	- - A -	- 0	800	1	100	%	6.9.20
pn57 power off KI DC volt.	04 39	- - G M - -	- - - -	- 0	32767	1	5	-	6.9.22
pn58 quick stop mode	04 3A	B g G - - -	- - A -	- E 0	3	1	0	-	6.7.13
pn59 quick stop level	04 3B	B g G - - -	- - A -	- 0	200	1	200	%	6.7.13
pn60 quick stop acc/dec time	04 3C	B g G M S A	- - - -	- 0	300,00	0,01	2,00	s	6.7.13
pn62 dOH warning level	04 3E	- - G M S A	- - - -	- 0	200	1	100	°C	6.7.11
pn63 positioning delay	04 3F	B g G - - -	- - A -	- P - -0,02	327,67	0,01	-0,01	s	6.9.31
pn64 set GTR7 input selection	04 40	- - G M S A	- - E -	- 0	4095	1	0	-	6.7.19, 6.3.8
pn65 special functions	04 41	- - G M S A	- - - -	- 0	7	1	0	-	6.7.20, 6.7.19, 6.7.9
ru 0 inverter state	02 00	B g G M S A	R - - -	- 0	255	1	0	-	6.1.6
ru 1 set value display	02 01	B g G - - -	- - R -	- V -400	400	0,0125	0	Hz	6.1.6, 6.9.3
ru 2 ramp output display	02 02	B g G - - -	- - R -	- V -400	400	0,0125	0	Hz	6.1.6
ru 3 actual frequency display	02 03	B g G M S A	R - - V	- -400	400	0,0125	0	Hz	6.1.6
ru 4 encoder 1 frequency	02 04	- - G - - -	- - A R	- - V -400	400	0,0125	0	Hz	
ru 5 encoder 2 frequency	02 05	- - G - - -	- - A R	- - V -400	400	0,0125	0	Hz	
ru 6 calculated act. freq.	02 06	- - G - - -	- - A R	- - V -400	400	0,0125	0	Hz	
ru 7 actual value display	02 07	- - G - - -	- - R -	- V -400	400	0,0125	0	Hz	6.1.7
ru 9 encoder 1 speed	02 09	- - G - - -	- - R -	- V -32000	32000	1	0	rpm	6.1.7

Parameter

Parameter	Adr.	Control	Properties	min.	max.	Step	default	[?]	see on Page
ru 10 encoder 2 speed	020A	- - G - - - R - - V		-32000	32000	1	0	rpm	6.1.7
ru 13 actual utilization	020D	B g G M S A R - - - 0		0	65535	1	0	%	6.11.6, 6.1.8
ru 14 peak utilization	020E	B g G M S A - - - 0		0	65535	1	0	%	6.1.8
ru 15 apparent current	020F	B g G M S A R - - - 0		0	6553,5	0,1	0	A	6.1.8
ru 16 peak apparent current	0210	B g G M S A - - - 0		0	6553,5	0,1	0	A	6.1.8
ru 17 active current	0211	B g G M S A R - - - -3276,7		-3276,7	3276,7	0,1	0	A	6.12.6, 6.1.9
ru 18 actual DC voltage	0212	B g G M S A R - - - 0		0	1000	1	0	V	6.12.6, 6.1.9
ru 19 peak DC voltage	0213	B g G M S A - - - 0		0	1000	1	0	V	6.1.9
ru 20 output voltage	0214	B g G M S A R - - - 0		0	778	1	0	V	6.1.9
ru 21 input terminal state	0215	B g G M S A R - - - 0		0	4095	1	0	-	6.1.10, 6.3.5
ru 22 internal input state	0216	B g G M S A R - - - 0		0	4095	1	0	-	6.1.10, 6.3.8
ru 23 output condition state	0217	B g G M S A R - - - 0		0	255	1	0	-	6.1.11
ru 24 state of output flags	0218	B g G M S A R - - - 0		0	255	1	0	-	6.1.11
ru 25 output terminal state	0219	B g G M S A R - - - 0		0	255	1	0	-	6.1.12, 6.3.18
ru 26 active parameter set	021A	B g G M S A R - - - 0		0	7	1	0	-	6.1.12
ru 27 AN1 pre amplifier disp.	021B	B g G M S A R - - - -100,0		-100,0	100,0	0,1	0	%	6.1.12, 6.2.3, 6.4.4
ru 28 AN1 post amplifier disp.	021C	B g G M S A R - - - -400,0		-400,0	400,0	0,1	0	%	6.1.12, 6.2.3, 6.4.4
ru 29 AN2 pre amplifier disp.	021D	- g G M S - R - - - -100,0		-100,0	100,0	0,1	0	%	6.1.13, 6.2.3, 6.4.4
ru 30 AN2 post amplifier disp.	021E	- g G M S - R - - - -400,0		-400,0	400,0	0,1	0	%	6.1.13, 6.2.3, 6.4.4
ru 31 AN3 pre amplifier disp.	021F	- - G M S - R - - - -100,0		-100,0	100,0	0,1	0	%	6.1.13, 6.2.3, 6.4.4
ru 32 AN3 post amplifier disp.	0220	- - G M S - R - - - -400,0		-400,0	400,0	0,1	0	%	6.1.13, 6.2.3, 6.4.4
ru 33 ANOUT1 pre ampl. disp.	0221	B g G M S A R - - - -400,0		-400,0	400,0	0,1	0	%	6.1.14, 6.2.12
ru 34 ANOUT1 post ampl. disp.	0222	B g G M S A R - - - -115,0		-115,0	115,0	0,1	0	%	6.1.14, 6.2.12
ru 35 ANOUT2 pre ampl. disp.	0223	- g G M S - R - - - -400,0		-400,0	400,0	0,1	0	%	6.1.14, 6.2.12
ru 36 ANOUT2 post ampl. disp.	0224	- - G M S - R - - - -115,0		-115,0	115,0	0,1	0	%	6.1.14, 6.2.12
ru 37 motorpoti actual value	0225	B g G M S A R - - - -100,00		-100,00	100,00	0,01	0	%	6.1.14, 6.9.8
ru 38 power module temperature	0226	B g G M S A R - - - 0		0	150	1	0	°C	6.1.15
ru 39 OL counter display	0227	B g G M S A R - - - 0		0	100	1	0	%	6.1.15
ru 40 power on counter	0228	B g G M S A R - - - 0		0	65535	1	0	h	6.1.15
ru 41 modulation on counter	0229	B g G M S A R - - - 0		0	65535	1	0	h	6.1.15
ru 42 modulation grade	022A	B g G M S A R - - - 0		0	110	1	0	%	6.1.15
ru 43 timer 1 display	022B	B g G M S A - - - 0		0	655,35	0,01	0	-	6.1.15, 6.9.12
ru 44 timer 2 display	022C	B g G M S A - - - 0		0	655,35	0,01	0	-	6.1.16, 6.9.12
ru 45 act. carrier frequency	022D	B g G M S A R - - - 0		0	4	1	0	-	6.1.16
ru 46 motor temperature	022E	B g G M S - R - - - 0		0	255	1	0	°C	6.1.16
ru 52 ext. PID out disp.	0234	B g G M S A R - - - -100,0		-100,0	100,0	0,1	0	%	6.1.17, 6.4.4
ru 53 AUX display	0235	B g G M S A R - - - -400,0		-400,0	400,0	0,1	0	%	6.1.17, 6.12.6
ru 68 rated DC voltage	0244	B g G M S A R - - - 0		0	1000	1	0	V	
sy 2 inverter identifier	0002	B g G M S A - - - identifier		identifier	identifier	1	identifier	hex	6.1.23
sy 3 power unit code	0003	B g G M S A - - - E - 1		1	255	1	LTK	-	6.1.23
sy 6 inverter address	0006	B g G M S A - - - E - 0		0	239	1	1	-	6.1.23, 11.2.3
sy 7 baud rate ext. bus	0007	B g G M S A - - - E - 0		0	6	1	5	-	6.1.23, 11.2.3
sy 9 HSP5 watchdog time	0009	B g G M S A - - - E - 0,00:off		0,00:off	10,00	0,01	0,00:off	s	6.1.24, 11.2.3
sy11 baud rate int. bus	000B	B g G M S A - - - E - 3		3	11	1	5	-	6.1.24, 11.2.3
sy32 scope timer	0020	B g G M S A R - - - 0		0	65535	1	0	-	6.1.24
sy41 control word (high)	0029	- - G M S A - - - E - 0		0	65535	1	0	hex	6.1.24, 11.2.4
sy42 status word (high)	002A	- - G M S A R - - - 0		0	65535	1	0	hex	6.1.25, 11.2.5
sy43 control word (long)	002B	- - G M S A - - - E - 2^31		2^31	2^31 - 1	1	0	hex	6.1.25, 11.2.4
sy44 status word (long)	002C	- - G M S A R - - - E - 2^31		2^31	2^31 - 1	1	0	hex	6.1.25, 11.2.5
sy50 control word (low)	0032	B g G M S A - - - E - 0		0	65535	1	0	hex	6.1.25, 6.4.8, 11.2.4
sy51 status word (low)	0033	B g G M S A R - - - 0		0	65535	1	0	hex	6.1.25, 11.2.4
sy52 set speed value	0034	B g G M S A - - - -16000		-16000	16000	1	0	rpm	6.1.26, 11.2.4
sy53 actual speed value	0035	B g G M S A R - - - -16000		-16000	16000	1	0	rpm	6.1.25, 11.2.4
sy56 start display address	0038	B g G - - A - - E - 0		0	7FFFH	1	0203H	hex	6.1.25
ud 1 password	0801	B g G M S A - - - 0		0	9999	1	application	-	4.2.3, 4.4.3, 6.13.3
ud 2 maximum frequency mode	0802	B g - - - - - 0		0	2	1	0	-	6.5.3
ud 2 control type	0802	- - G M S A - - - E - 0		0	10	1	0	-	6.5.3
ud 5 auto store	0805	B g - - - - - 0		0	1	1	1	-	
ud 9 drive-mode-control	0809	B g G M S A - - - 0		0	11	1	0	-	4.4.4
ud15 cp selector	080F	B g G M S A - - - E - 1		1	36	1	1	-	6.13.4
ud16 cp address	0810	B g G M S A - - - E - -1		-1	32767	1	Tabelle	hex	6.13.4
ud17 cp set norm	0811	B g G M S A - - - E - 1		1	32767	1	1	-	6.13.4
ud18 divisor display norm	0812	B g G M S A - - - P E - -32767		-32767	32767	1	1	-	6.13.6
ud19 multiplier display norm	0813	B g G M S A - - - P E - -32767		-32767	32767	1	1	-	6.13.6
ud20 offset display norm	0814	B g G M S A - - - P E - -32767		-32767	32767	1	0	-	6.13.6
ud21 ctrl. display norm	0815	B g G M S A - - - P E - 0		0	1791	1	0	-	6.13.6
uf 0 rated frequency	0500	B g G M - A - P - V 0		0	400	0,0125	50	Hz	6.5.4
uf 1 boost	0501	B g G M - A - P - 0,0		0,0	25,5	0,1	2,0	%	6.5.4
uf 2 add. frequency	0502	B g G M - A - P - V -0,0125		-0,0125	400	0,0125	0:off	Hz	6.5.4
uf 3 add. voltage	0503	B g G M - A - P - 0,0		0,0	100,0	0,1	0,0	%	6.5.4
uf 4 delta boost	0504	B g G M - A - P - 0,0		0,0	25,5	0,1	0,0	%	6.5.4
uf 5 delta boost time	0505	B g G M - A - P - 0,00		0,00	10,00	0,01	0,00	s	6.5.4
uf 6 energy saving mode	0506	B g G M - A - P - 0		0	7	1	0	-	6.9.5
uf 7 energy saving factor	0507	B g G M - A - P - 0,0		0,0	130,0	0,1	70,0	%	6.9.5
uf 8 energy saving input sel.	0508	B g G M - A - E - 0		0	4095	1	0	-	6.9.5, 6.3.8
uf 9 voltage stabilisation	0509	B g G M - - - P E - 1		1	650:off	1	650:off	V	6.5.5
uf 10 max. voltage mode	050A	- - G M - A - P - 0		0	3	1	0	-	6.5.6

Parameter	Adr.	Control	Properties	min.	max.	Step	default	[?]	see on Page
uf 10 max. voltage mode	05 0A	B g - - - -	P - - 0		2	1	0	-	6.5.6
uf 11 carrier frequency	05 0B	B g G M S A	- P E - 0		LTK	1	LTK	-	6.5.6
uf 12 base block time	05 0C	B g G M S A	R - - - LTK		LTK	0,01	LTK	s	6.7.9
uf 13 base block voltage level	05 0D	B g G M S A	R - - - LTK		LTK	1	LTK	%	6.7.9
uf 15 hardw. curr. lim. mode	05 0F	- - G M S A	- - - - 0		2	1	1	-	6.7.3
uf 15 hardw. curr. lim. mode	05 0F	B g - - - -	- - - - 0		1	1	1	-	6.7.3
uf 16 autoboot configuration	05 10	B g G - - A	- P - - 0		3	1	0	-	
uf 17 autoboot gain	05 11	B g G - - A	- P - - 0,00		2,50	0,01	1,20	-	
uf 18 deadtime comp. mode	05 12	B g G M - -	- - - - 0		1	1	1	-	6.7.9
uf 19 volt.stab.PT1-timeconst.	05 13	- - G - - A	- - - - 0		10	1	0	-	6.5.5

1. Introduction

2. Summary

3. Hardware

4. Operation

5. Parameter

6. Functions

7. Start-up

8. Special Operation

9. Error Assistance

10. Project Planning

11. Networks

12. Annex

6.1 Operating and Appliance Date

6.2 Analog In- and Outputs

6.3 Digital In- and Outputs

6.4 Set Value and Ramp Adjustment

6.5 Voltage-/Frequency Characteristic (U/f) Adjustment

6.6 Motor Data Adjustment

6.7 Protective Functions

6.8 Parameter Sets

6.9 Special Functions

6.10 Encoder Interface

6.11 SMM

6.12 Technology Control

6.13 CP-Parameter Definition

6.1.1 Overview of the ru-Parameters 3

6.1.2 Overview of the In-Parameters 4

6.1.3 Overview of the Sy-Parameters 4

6.1.4 Explanation to Parameter Description 5

6.1.5 Description of the ru-Parameters 6

6.1.6 Description of the In-Parameters 17

6.1.7 Description of the Sy-Parameters 21

Chapter	Section	Page	Date	Name: Basis	©	KEB Antriebstechnik, 2002 All rights reserved
6	1	2	24.06.02	KEB COMBIVERT F5-G / B		

6. Functional Description

6.1 Operating and Appliance Data

The parameter groups „ru“ , „Sy“ and „In“ are described in this chapter. They serve for the operational monitoring, error analysis and evaluation as well as for the unit identification.

6.1.1 Overview of the ru-Parameters

The ru- (run) parameter group represents the multimeter of the inverter. Here speeds, currents, voltages etc. are displayed, with those a statement about the operating condition of the inverter can be made. Especially during startup or trouble shooting on a plant, this can turn out to be a great aid. Following parameters are available:

ru. 0	Inverter status
ru. 1	Set value display
ru. 2	Ramp output display
ru. 3	Actual frequency display
ru. 4	Encoder 1 frequency
ru. 5	Encoder 2 frequency
ru. 6	Calculated actual frequency
ru. 7	Actual value display
ru. 9	Encoder 1 speed
ru. 10	Encoder 2 speed
ru. 13	Actual utilization
ru. 14	Peak utilization
ru. 15	Apparent current
ru. 16	Apparent current/peak value
ru. 17	Active current
ru. 18	DC-link voltage
ru. 19	DC-link voltage/peak value
ru. 20	Output voltage
ru. 21	Input terminal state
ru. 22	Internal input state
ru. 23	Output condition state
ru. 24	State of output flags
ru. 25	Output terminal state
ru. 26	Active parameter set
ru. 27	AN1 display before amplification
ru. 28	AN1 display after amplification
ru. 29	AN2 display before amplification
ru. 30	AN2 display after amplification
ru. 31	AN3 display before amplification
ru. 32	AN3 display before amplification
ru. 33	Analog output 1 display before amplification
ru. 34	Analog output 1 display after amplification
ru. 35	Analog output 2 display before amplification
ru. 36	Analog output 2 display after amplification
ru. 37	Motorpoti - actual value
ru. 38	Power module temperature
ru. 39	OL-counter display
ru. 40	power on counter
ru. 41	Modulation on counter
ru. 42	Modulation grade
ru. 43	Timer 1 display
ru. 44	Timer 2 display
ru. 45	Actual carrier frequency
ru. 46	Motor temperature
ru. 52	External PID out display
ru. 53	AUX display
ru. 68	Rated DC voltage

6.1.2 Overview of the In-Parameters

The In- (Information) parameter group contains data and information on the identification of the hardware and software as well as on the type and number of the errors that occurred. Following parameters are available:

In. 0	Inverter type
In. 1	Rated inverter current
In. 3	Max. switching frequency
In. 4	Rated switching frequency
In. 5	Interface type
In. 6	Software version
In. 7	Software date
In. 8	Software version power circuit
In. 9	Software date power circuit
In. 10	Serial number (date)
In. 11	Serial number (counter)
In. 12	Serial number (Ackn.-No. High)
In. 13	Serial number (Ackn.-No. Low)
In. 14	Customer number (High)
In. 15	Customer number (Low)
In. 16	QS-Number
In. 17	Temperature mode
In. 22	User parameter 1
In. 23	User parameter 2
In. 24	Last error
In. 25	Error diagnosis
In. 26	Error counter OC
In. 27	Error counter OL
In. 28	Error counter OP
In. 29	Error counter OH
In. 30	Error counter OHI

6.1.3 Overview of the Sy-Parameters

As the name already says the Sy- (system) parameter group contains system-specific parameters. Following parameters are available:

Sy. 2	Inverter identifier
Sy. 3	Power unit code
Sy. 6	Inverter address
Sy. 7	Baud rate ext. bus
Sy. 9	HSP5 Watchdog time
Sy. 11	Baud rate int. bus
Sy. 32	Scope timer
Sy. 41	Control word high
Sy. 42	Status word high
Sy. 43	Control word long
Sy. 44	Status word long
Sy. 50	Control word low
Sy. 51	Status word low
Sy. 52	Set speed value
Sy. 53	Actual speed value
Sy. 56	Start display address

6.1.4 Explanation to Parameter Description

The parameters described in the following receive a symbol line with following details for a better overview:

Parameter group, parameter number and parameter name

Free for user adjustments

Resolution and value range depend on ud.2

Parameter address

ru. 1	Set value display									
Adr.										
0201h	<input checked="" type="checkbox"/>	<input checked="" type="checkbox"/>	<input checked="" type="checkbox"/>	-400	400	0,0125	Hz	-		

Value range

Lower limit Upper limit

Unit

Resolution, increments Default value

Enter parameter

- after „Enter“ active
- immediately active

Parameter

- set-programmable
- not programmable

Parameter

- writable
- read-only

Information line

Contains special features, tips and cross references

6.1.5 Description of the ru-Parameters


ru. 0 Inverter status									
Adr.									
0200h	<input type="checkbox"/>	<input type="checkbox"/>	<input type="checkbox"/>	0	78	-	-	-

The inverter status shows the current operating condition of the inverter (e.g. constant forward run, standstill etc.). In the case of an error the current error message is displayed, even if the display has already been reset with ENTER (error-LED on the operator is still blinking). For more information about status messages as well as its cause and removal refer to Chapter 9 „Error Diagnosis“.


ru. 1 Set value display										
Adr.										
0201h	<input type="checkbox"/>	<input type="checkbox"/>	<input type="checkbox"/>	-400	400	0.0125	Hz	-	

Display of current setpoint frequency. The operator displays additionally „noP“ and „LS“ if the control release or the direction of rotation are not switched.

A counter-clockwise rotary field (reverse) is represented by a negative sign. Precondition is the phase-correct connection of the motor.



counter-clockwise rotation (reverse)



clockwise rotation (forward)

ru. 2 Ramp output display										
Adr.										
0202h	<input type="checkbox"/>	<input type="checkbox"/>	<input type="checkbox"/>	-400	400	0,0125	Hz	-	

The indicated actual frequency corresponds to the rotary field frequency given out at the ramp output. The representation is the same as at ru.1.

ru. 3 Actual frequency display										
Adr.										
0203h	<input type="checkbox"/>	<input type="checkbox"/>	<input type="checkbox"/>	-400	400	0.0125	Hz	-	

The indicated actual frequency corresponds to the rotary field frequency given out at the inverter output. The representation is the same as at ru.1.

ru. 4 Encoder 1 frequency										
Adr.										
0204h	<input type="checkbox"/>	<input type="checkbox"/>	<input type="checkbox"/>	-400		400	0,0125	Hz	-

The displayed value corresponds to the actual frequency measured at the encoder input 1. The value „0“ is indicated, even if no encoder interface is available.

ru. 5 Encoder 2 frequency										
Adr.										
0205h	<input type="checkbox"/>	<input type="checkbox"/>	<input type="checkbox"/>	-400		400	0,0125	Hz	-

The displayed value corresponds to the actual frequency measured at the encoder input 2. The value „0“ is indicated, even if no encoder interface is available.

ru. 6 Calculated actual frequency										
Adr.										
0206h	<input type="checkbox"/>	<input type="checkbox"/>	<input type="checkbox"/>	-400		400	0,0125	Hz	-

The displayed value corresponds to the actual frequency calculated from the inverter.

ru. 7 Actual value display										
Adr.										
0207h	<input type="checkbox"/>	<input type="checkbox"/>	<input type="checkbox"/>	-400		400	0,0125	Hz	-

The displayed value corresponds to the rotary field frequency given out at the inverter output (cS.0 Bit 0...2 = 0 or 1). At cS.0 Bit 0...2 = 2 the frequency of the channel selected in cS.1 is displayed (ru.4/5/6).

ru. 9 Encoder 1 speed										
Adr.										
0209h	<input type="checkbox"/>	<input type="checkbox"/>	<input type="checkbox"/>	-4000		4000	0,125	rpm	-

The displayed speed corresponds to the actual speed measured at the encoder input 1. The value „0“ is indicated, even if no encoder interface is available.

ru.10 Encoder 2 speed										
Adr.										
020Ah	<input type="checkbox"/>	<input type="checkbox"/>	<input type="checkbox"/>	-4000		4000	0,125	rpm	-

The displayed speed corresponds to the actual speed measured at the encoder input 2. The value „0“ is indicated, even if no encoder interface is available.

ru.13 Actual utilization									
Adr.									
020Dh	<input type="checkbox"/>	<input type="checkbox"/>	<input type="checkbox"/>	0	255	1	%	-
Display of the current utilization referred to the rated current of the inverter. Only positive values are indicated, thus it is not possible to differentiate between a motoric or generative operation.									

ru.14 Peak utilization									
Adr.									
020Eh	<input checked="" type="checkbox"/>	<input type="checkbox"/>	<input type="checkbox"/>	0	255	1	%	-
ru.14 permits the detection of short-time peak loads within an operating cycle. The highest occurred value of ru.13 is stored in ru.14. The peak value memory can be cleared by pressing the keys UP, DOWN or ENTER and by bus through writing any chosen value to the address of ru.14. Switching off the inverter also results in a clearing of the memory.									

ru.15 Apparent current									
Adr.									
020Fh	<input type="checkbox"/>	<input type="checkbox"/>	<input type="checkbox"/>	0	unit-dependent	0.1	A	-
Display of the current apparent current. The maximum values depend on the size of the inverter.									

ru.16 Apparent current / peak value									
Adr.									
0210h	<input checked="" type="checkbox"/>	<input type="checkbox"/>	<input type="checkbox"/>	0	unit-dependent	0.1	A	-
ru.16 permits the detection of short-time peak currents within an operating cycle. The highest occurred value of ru.15 is stored in ru.16. The peak value memory can be cleared by pressing the keys UP, DOWN or ENTER and by bus through writing any chosen value to the address of ru.16. Switching off the inverter also results in a clearing of the memory.									

ru.17 Active current									
Adr.									
0211h	<input type="checkbox"/>	<input type="checkbox"/>	<input type="checkbox"/>	-unit-depend.	+unit-dependent	0.1	A	-

Display of the torque-forming active current (stator losses already deducted). Negative current corresponds to generative operation, positive current corresponds to motoric operation. The more precise the motor data are entered, the more precise is the indication of the active current. The maximum values depend on the size of the inverter.

ru.18 DC-link voltage									
Adr.									
0212h	<input type="checkbox"/>	<input type="checkbox"/>	<input type="checkbox"/>	0	1000	1	V	-

Display of current DC-link voltage. Typical values are
 Normal operation: 230V-class 300-330V over volt. (E.OP): approx. 400V under volt. (E.UP): approx. 216V
 400V-class 530-620V approx. 800V approx. 240V

ru.19 DC-link voltage / peak value									
Adr.									
0213h	<input checked="" type="checkbox"/>	<input type="checkbox"/>	<input type="checkbox"/>	0	1000	1	V	-

ru.19 permits the detection of short-time voltage rises within an operating cycle. The highest occurred value of ru.18 is stored in ru.19. The peak value memory can be cleared by pressing the keys UP, DOWN or ENTER and by bus through writing any chosen value to the address of ru.19. Switching off the inverter also results in a clearing of the memory.

ru.20 Output voltage									
Adr.									
0214h	<input type="checkbox"/>	<input type="checkbox"/>	<input type="checkbox"/>	0	778	1	V	-

Display of the current output voltage.

ru.21		Input terminal state							
Adr.									
0215h	<input type="checkbox"/>	<input type="checkbox"/>	<input type="checkbox"/>	0	4095	1	-	-

Display of the digital inputs controlled currently. The logic levels are indicated at the input terminals or at the internal inputs regardless of the following logic operations (also see Chapt. 6.3 „Digital inputs“). According to following table a specific decimal value is given out for each digital input. If several inputs are controlled, the sum of the decimal values is indicated.

Bit -No.	Decimal Value	Input	Terminal
0	1	ST (prog. input „control release/Reset“)	X2A.16
1	2	RST (prog. input „Reset“)	X2A.17
2	4	F (prog. input „forward“)	X2A.14
3	8	R (prog. input „reverse“)	X2A.15
4	16	I1 (prog. input 1)	X2A.10
5	32	I2 (prog. input 2)	X2A.11
6	64	I3 (prog. input 3)	X2A.12
7	128	I4 (prog. input 4)	X2A.13
8	256	IA (internal input A)	none
9	512	IB (internal input B)	none
10	1024	IC (internal input C)	none
11	2048	ID (internal input D)	none

ru.22		Internal input state							
Adr.									
0216h	<input type="checkbox"/>	<input type="checkbox"/>	<input type="checkbox"/>	0	4095	1	-	-

Display of the digital external and internal inputs set currently. The input is only regarded as set if it is available as effective signal to the further processing (i.e. accepted through Strobe, edge-triggering or logic operation). According to following table a specific decimal value is given out for each digital input. If several inputs are controlled, the sum of the decimal values (see ru.21) is indicated (also see Chapt. 6.3 „Digital inputs“)

ru.23	Output condition state								
Adr.									
0217h	<input type="checkbox"/>	<input type="checkbox"/>	<input type="checkbox"/>	0	255	1	-	-

With parameters do.0...do.7 switching conditions can be selected, that serve as a base for setting the outputs. This parameter indicates which of the selected switching conditions are met before they are linked or inverted by programmable logic (also see Chapt. 6.3 „Digital outputs“). According to following table a specific decimal value is given out for the switching conditions. If several of the selected switching conditions are met, the sum of the decimal values is indicated.

Bit -No.	Decimal value	Output
0	1	switching condition 0 (do.0)
1	2	switching condition 1 (do.1)
2	4	switching condition 2 (do.2)
3	8	switching condition 3 (do.3)
4	16	switching condition 4 (do.4)
5	32	switching condition 5 (do.5)
6	64	switching condition 6 (do.6)
7	128	switching condition 7 (do.7)

ru.24	State of output flags								
Adr.									
0217h	<input type="checkbox"/>	<input type="checkbox"/>	<input type="checkbox"/>	0	255	1	-	-

Display of the links after logic step 1. The selected switching conditions are linked in logic step 1 (do.8...24) and indicated here (see Chapt. 6.3 „Digital outputs“). According to following table a specific decimal value is given out for each linkage. If several links are set, the sum of the decimal values is indicated.

Bit -No.	Decimal value	Output
0	1	flag 0
1	2	flag 1
2	4	flag 2
3	8	flag 3
4	16	flag 4
5	32	flag 5
6	64	flag 6
7	128	flag 7

ru.25 Output terminal state									
Adr.									
0218h	<input type="checkbox"/>	<input type="checkbox"/>	<input type="checkbox"/>	0	255	1	-	-

Display of the external and internal digital output set currently. According to following table a specific decimal value is given out for each digital output. If several outputs are set, the sum of the decimal values is indicated.

Bit-No.	Decimal value	Output	Terminal
0	1	O1 (transistor output 1)	X2A.18
1	2	O2 (transistor output 2)	X2A.19
2	4	R1 (relay RLA,RLB,RLC)	X2A.24...26
3	8	R2 (relay FLA,FLB,FLC)	X2A.27...29
4	16	OA (internal output A)	none
5	32	OB (internal output B)	none
6	64	OC (internal output C)	none
7	128	OD (internal output D)	none

ru.26 Active parameter set									
Adr.									
021Ah	<input type="checkbox"/>	<input type="checkbox"/>	<input type="checkbox"/>	0	7	1	-	-

The frequency inverter F5-GENERAL and F5-BASIC can fall back on 8 internal parameter sets (0-7). Through programming the inverter can change parameter sets autonomously and can thus start different modes of operation. This parameter shows the parameter set, with which the inverter is operating currently. Independent of it another parameter set can be edited by bus (also see chapter 6.8 „Parameter sets“).

ru.27 Analog input 1 / display before amplification									
Adr.									
021Bh	<input type="checkbox"/>	<input type="checkbox"/>	<input type="checkbox"/>	-100	100	0.1	%	-

This parameter indicates the value of the analog signal AN1 on the differential voltage input (terminal X2A.1 / X2A.2) before signal amplification in percent. In dependence on An.0 the indicated value 0...±100 % corresponds to: 0...±10 V; 0...±20 mA or 4...20 mA (also see Chapt. 6.2 „Analog inputs“).

ru.28 Analog input 1 / display after amplification									
Adr.									
021Ch	<input type="checkbox"/>	<input type="checkbox"/>	<input type="checkbox"/>	-400	400	0.1	%	-

This parameter shows the value of the analog signal AN1 in percent after passing the characteristic amplifier. The range of indication is limited to ±400 % (also see Chapt. 6.2 „Analog inputs“).

ru.29	Analog input 2 / display before amplification								
Adr.									
021Dh	<input type="checkbox"/>	<input type="checkbox"/>	<input type="checkbox"/>	-100	100	0.1	%	-

This parameter shows the value of the analog signal AN2 on the differential voltage input (terminal X2A.3 / X2A.4) before signal amplification in percent. In dependence on An.10 the indicated value of 0...±100 % corresponds to: 0...±10 V; 0...±20 mA or 4...20 mA (also see Chapt. 6.2 „Analog inputs“).

ru.30	Analog input 2 / display after amplification								
Adr.									
021Eh	<input type="checkbox"/>	<input type="checkbox"/>	<input type="checkbox"/>	-400	400	0.1	%	-

This parameter shows the value of the analog signal AN2 in percent after passing the characteristic amplifier. The range of indication is limited to ±400 % (also see Chapt. 6.2 „Analog inputs“).

ru.31	Analog input 3 / display before amplification								
Adr.									
021Fh	<input type="checkbox"/>	<input type="checkbox"/>	<input type="checkbox"/>	-100	100	0.1	%	-

This parameter shows the value of the analog signal on the optionally analog input AN3 before signal amplification in percent. The indicated value of 0...±100 % corresponds to 0...±10 V (also see Chapt. 6.2 „Analog inputs“).

ru.32	Analog input 3 / display after amplification								
Adr.									
0220h	<input type="checkbox"/>	<input type="checkbox"/>	<input type="checkbox"/>	-400	400	0.1	%	-

This parameter shows the value of the analog signal AN3 in percent after passing the characteristic amplifier. The range of indication is limited to ±400 % (also see Chapt. 6.2 „Analog inputs“).

ru.33 Analog output 1 / display before amplification									
Adr.									
0221h	<input type="checkbox"/>	<input type="checkbox"/>	<input type="checkbox"/>	-400	400	0.1	%	-

This parameter shows the value of the analog signal ANOUT1 in percent before passing the characteristic amplifier (also see Chapt. 6.2. „Analog outputs“).

ru.34 Analog output 1 / display after amplification									
Adr.									
0222h	<input type="checkbox"/>	<input type="checkbox"/>	<input type="checkbox"/>	-100	100	0.1	%	-

This parameter shows the value of the signal given out on analog output ANOUT1 (terminal X2A.5) in percent. A value of 0...±100 % corresponds to an output signal of 0...±10 V (also see Chapt. 6.2 „Analog outputs“).

ru.35 Analog output 2 / display before amplification									
Adr.									
0223h	<input type="checkbox"/>	<input type="checkbox"/>	<input type="checkbox"/>	-400	400	0.1	%	-

This parameter shows the value of the analog signal ANOUT2 in percent before passing the characteristic amplifier (also see Chapt. 6.2 „Analog outputs“).

ru.36 Analog output 2 / display after amplification									
Adr.									
0224h	<input type="checkbox"/>	<input type="checkbox"/>	<input type="checkbox"/>	0	100	0.1	%	-

This parameter shows the value of the signal given out on analog output ANOUT2 (terminal X2A.6) in percent. The value of 0...±100 % corresponds to an output signal of 0...±10 V (also see Chapt. 6.2 „Analog outputs“).

ru.37 Motorpoti - actual value									
Adr.									
2025h	<input checked="" type="checkbox"/>	<input checked="" type="checkbox"/>	<input type="checkbox"/>	-100	100	0.01	%	0

The motorpoti-function in the KEB COMBIVERT imitates a mechanical, motor operated potentiometer. The control occurs via 2 programmable inputs („poti up“ and „poti down“). The display is limited by oP.53/54. The adjustment of the motorpoti is done with the parameters oP.50...oP.59 (also see Chapt. 6.9.3 „Motorpoti“). By way of the bus the motorpoti can be set to any chosen value between -100...100%. In addition to the inputs the motorpoti can be operated with the keys „UP“ and „DOWN“. Then the rate of change is not constant.

ru.38 Power module temperature									
Adr.									
0226h	<input type="checkbox"/>	<input type="checkbox"/>	<input type="checkbox"/>	0	150	1	°C	-

ru.38 shows the current power moduls temperature of the inverter.

ru.39 OL - counter display									
Adr.									
0227h	<input type="checkbox"/>	<input type="checkbox"/>	<input type="checkbox"/>	0	100	1	%	-

In order to preclude „E.OL“ - errors by too high load (load reduction in due time), the internal count of the OL-counter can be made visible with this indication. At 100 % the inverter switches off with error „E.OL“. The error can be reset only after a cooling time (blinking display „E.nOL“).

ru.40 Operating hours meter									
Adr.									
0228h	<input checked="" type="checkbox"/>	<input type="checkbox"/>	<input type="checkbox"/>	0	65535	1	h	-

The operating hours meter shows the time the inverter was switched on. The indicated value comprises all operating phases. On reaching the maximum value (approx. 7.5 years) the indication remains on the maximum value.

ru.41 Modulation hours meter									
Adr.									
0229h	<input checked="" type="checkbox"/>	<input type="checkbox"/>	<input type="checkbox"/>	0	65535	1	h	-

The modulation hours meter shows the time the inverter was active (power modules controlled). On reaching the maximum value (approx. 7.5 years) the indication remains on the maximum value.

ru.42 Modulation factor									
Adr.									
022Ah	<input type="checkbox"/>	<input type="checkbox"/>	<input type="checkbox"/>	0	110	1	%	-

The modulation factor shows the output voltage in percent. 100 % correspond to the input voltage (no-load). At a value of > 100 % the inverter works with overmodulation.

ru.43 Timer 1 / display									
Adr.									
022Bh	<input checked="" type="checkbox"/>	<input type="checkbox"/>	<input type="checkbox"/>	0	655.35	0.01	s / h	-

The count of the free-programmable timer 1 is indicated. The display is done either in seconds, in hours or in slopes/100 (see LE.21). The counter can a adjusted to any chosen value by keyboard or bus. The programming of the counter is done with the parameters LE.17...LE.21 (also see Chapt. 6.9.4 „Timer“).

ru.44 Timer 2 / display									
Adr.									
022Ch	<input checked="" type="checkbox"/>	<input type="checkbox"/>	<input type="checkbox"/>	0	655.35	0.01	s / h	-

The count of the free-programmable timer 2 is indicated. The display is done either in seconds, in hours or in slopes/100 (see LE.26). The counter can be adjusted to any chosen value by keyboard or bus. The programming of the counter is done with the parameters LE.22...LE.26 (also see Chapt. 6.9.4 „Timer“).

ru.45 Actual switching frequency									
Adr.									
022Dh	<input type="checkbox"/>	<input type="checkbox"/>	<input type="checkbox"/>	0	4	1	-	-

Shows the current switching frequency of the inverter. The displayed value corresponds to following switching frequencies:
 0 = 2 kHz 3 = 12 kHz
 1 = 4 kHz 4 = 16 kHz
 2 = 8 kHz

ru.46 Motor temperature (optionally)									
Adr.									
022Eh	<input type="checkbox"/>	<input type="checkbox"/>	<input type="checkbox"/>	0	255	1	°C	-

Indicates the current motor temperature. Precondition for this function is aspecial power circuit. The temperature detection is connected to the terminals T1/T2.
 0: T1/T2 closed 253, 254: broken cable; short circuit; detection error
 255: T1/T2 open

ru.52 External PID out display									
Adr.									
0234h	<input type="checkbox"/>	<input type="checkbox"/>	<input type="checkbox"/>	-100,0	100,0	0,1	%	-

A universal PI-controller is integrated into the inverter. It can be used externally as well as internally. The indicated manipulated variable is given out in a range of ±100 %.

ru.53 AUX display									
Adr.									
0235h	<input type="checkbox"/>	<input type="checkbox"/>	<input type="checkbox"/>	-400,0	400,0	0,1	%	-

The AUX input is setting with An.30. This parameter shows the value of the analog signal AUX in percent. The range of indication is limited to ±400 % (also see Chapt. 6.2 „Analog inputs“).

ru.68 Rated DC voltage									
Adr.									
0244h	<input type="checkbox"/>	<input type="checkbox"/>	<input type="checkbox"/>	0	1000	1	V	-

This parameter shows the rated DC-link voltage automatically determined by the inverter. The value is measured at switch-on.

6.1.6 Description of the In-Parameters

In. 0	Inverter type								
Adr.									
0E00h	<input type="checkbox"/>	<input type="checkbox"/>	<input type="checkbox"/>	0h	FFFFh	1	hex	-	

The inverter type is displayed in hexadecimal numbers. The bits have following meaning:

Bit 0-4	Unit size	05, 07, 09 etc.		
Bit 5	Voltage class	0 = 230 V 1 = 400 V		
Bit 6	Phase number	0 = 1-phase 1 = 3-phase		
Bit 7	free			
Bit 8-12	Housing	0 = A	10 = K	20 = U
		1 = B	11 = L	21 = V
		2 = C	12 = M	22 = W
		3 = D	13 = N	23 = X
		4 = E	14 = O	24 = Y
		5 = F	15 = P	25 = Z
		6 = G	16 = Q	
		7 = H	17 = R	
		8 = I	18 = S	
		9 = J	19 = T	
Bit 13-15	Control	0 = G 1 = M 2 = B 3 = S 4 = A		

Example:

hex	0				4				0				A			
binary	0	0	0	0	0	1	0	0	0	0	0	0	1	0	1	0
decimal	0				4				0				10			

=> 10.F5 G-Control / E-housing / 230V / 1ph.

In. 1	Rated inverter current								
Adr.									
0E01h	<input checked="" type="checkbox"/>	<input type="checkbox"/>	<input type="checkbox"/>	0	710	0.1	A	-	

Display of the rated inverter current in A. The value is determined from the power circuit identification (P-ID) and cannot be changed.

In. 3 Max. switching frequency									
Adr.									
0E03h	<input type="text"/>	<input type="text"/>	<input type="text"/>	0	4	1	-	P-ID
Display of the maximum possible switching frequency in kHz for this inverter. The displayed value corresponds to following switching frequencies: 0: 2 kHz / 1: 4 kHz / 2: 8 kHz / 3: 12 kHz / 4: 16 kHz									

In. 4 Rated switching frequency									
Adr.									
0E04h	<input type="text"/>	<input type="text"/>	<input type="text"/>	0	4	1	-	P-ID
Display of the rated switching frequency. The displayed value corresponds to the following switching frequencies: 0: 2 kHz / 1: 4 kHz / 2: 8 kHz / 3: 12 kHz / 4: 16 kHz									

In. 6 Software version									
Adr.									
0E06h	<input type="text"/>	<input type="text"/>	<input type="text"/>	0.00	9.99	0.01	-	-
Display of the software version number.. 1. and 2. digit: Software version (z.B. 2.1) 3. digit: Special version (0 = standard)									

In. 7 Software date									
Adr.									
0E07h	<input type="text"/>	<input type="text"/>	<input type="text"/>	-	-	0.1	-	-
Display of the software date. The value contains day, month and year, from the year only the last digit is indicated. Example: Display = 2102.0 Date = 21.02.2000									

In. 8 Software version LT									
Adr.									
0E08h	<input type="checkbox"/>	<input type="checkbox"/>	<input type="checkbox"/>	0.00	9.99	0.01	-	-

This parameter shows the software version of the power section. Definition like at In.6.

In. 9 Software date LT									
Adr.									
0E09h	<input type="checkbox"/>	<input type="checkbox"/>	<input type="checkbox"/>	-	-	0.1	-	-

Display of the software date of the power section. Display and value range like at In.7.

In.10	Serial number / date	0E0Ah							
In.11	Serial number / counter	0E0Bh							
In.12	Serial number / Ackn.-No. high	0E0Ch							
In.13	Serial number / Ackn.-No. low	0E0Dh							
In.14	Customer number / high	0E0Eh							
In.15	Customer number / low	0E0Fh							
In.16 QS-number		0E10h							
Adr.									
s.a.	<input checked="" type="checkbox"/>	<input type="checkbox"/>	<input type="checkbox"/>	0	65535	1	-	0

The serial number and the customer number identify the inverter. The QS-number contains production internal information.

In.17 Temperature mode									
Adr.									
0E11h	<input type="checkbox"/>	<input type="checkbox"/>	<input type="checkbox"/>	0	P-ID	1	-	P-ID

This parameter is for service personell only.

In.22 User parameter 1									
Adr.									
0E16h	<input checked="" type="checkbox"/>	<input type="checkbox"/>	<input type="checkbox"/>	0	65535	1	-	0

This parameter is not assigned to any function and is available to the user for input.

In.23 User parameter 2									
Adr.									
0E17h	<input checked="" type="checkbox"/>	<input type="checkbox"/>	<input type="checkbox"/>	0	65535	1	-	0

This parameter is not assigned to any function and is available to the user for input.

In.24 Last error									
Adr.									
0E18h	<input type="checkbox"/>	<input type="checkbox"/>	<input type="checkbox"/>	0	255	1	-	-

In.24 shows the last error that occurred. E. UP is not stored. The error messages are described at chapter 9.

In.25 Error diagnosis									
Adr.									
0E19h	<input type="checkbox"/>	<input checked="" type="checkbox"/>	<input type="checkbox"/>	0	65535	1	-	4095

Shows the last 8 errors that occurred (in the sets 0...7). The oldest error is in set 7. Between errors of the same type a difference time is determined and stored too.

Bit 0...11 Value 0...4094 difference time minutes
 Value 4095 difference time > 4094 minutes

Bit 12...15	Value	Error type	Value	Error type	Value	Error type
	0	no error	3	E.OP	6...15	free
	1	E.OC	4	E.OH		
	2	E.OL	5	E.OHI		

In.26	Error counter OC	0E1Ah							
In.27	Error counter OL	0E1Bh							
In.28	Error counter OP	0E1Ch							
In.29	Error counter OH	0E1Dh							
In.30	Error counter OHI	0E1Eh							
Adr.									
s.o.	<input checked="" type="checkbox"/>	<input type="checkbox"/>	<input type="checkbox"/>	0	65535	1	-	0

The error counters (for E.OC, E.OL, E.OP, E.OH, E.OHI) specify the total number of errors of each error type.

6.1.7 Description of the Sy-Parameters

Sy. 2 Inverter identifier									
Adr.									
0002h	<input checked="" type="checkbox"/>	<input type="checkbox"/>	<input type="checkbox"/>	0000	9999	1	hex	-

A unique number is assigned to each type of frequency inverter which identifies the hard- and software. This value is used for example by COMBIVIS to load the correct configuration files. Sy.2 kann mit dem angezeigten Wert beschrieben werden (z.B. zur Identifikation von Downloadlisten).

Sy. 3 Power unit code									
Adr.									
0003h	<input checked="" type="checkbox"/>	<input type="checkbox"/>	<input type="checkbox"/>	-255	255	1	P-ID	-

On the basis of the power circuit identification the control recognizes the used power circuit respectively a change of the power circuit and adjusts certain parameters accordingly. To accept a new P-Id enter positive values (see chap. 9 „E.Puch“).

Sy. 6 Inverter address									
Adr.									
0006h	<input checked="" type="checkbox"/>	<input type="checkbox"/>	<input checked="" type="checkbox"/>	0	239	1	-	1

With Sy.6 the address is adjusted under which the inverter is addressed by „COMBIVIS“ or another control. The possible values are between 0 and 239, the default value is 1. If several inverters are operated simultaneously on the bus, it is absolutely necessary to assign different addresses, since otherwise communication problems arise because several inverters may responded at the same time. The development info DIN 66019II protocol (C0.F5.01I-K001) contains further information.

Sy. 7 Baud rate ext. bus									
Adr.									
0007h	<input checked="" type="checkbox"/>	<input type="checkbox"/>	<input checked="" type="checkbox"/>	0	6	1	-	5

Following values are possible for the baudrate of the serial interface:

Parameter value	Baudrate
0	1200 baud
1	2400 baud
2	4800 baud
3 (default)	9600 baud
4	19200 baud
5	38400 baud
6	55500 baud

If the value for the baudrate is changed over the serial interface, it can only be changed again by way of the keyboard or after adapting the baudrate of the master, since no communication is possible in the case of different baudrates between master and slave.

If problems occur during the data transmission, select a baudrate up to max. 38400 baud.

Sy. 9 HSP5 Watchdog time									
Adr.									
0009h	<input checked="" type="checkbox"/>	<input type="checkbox"/>	<input checked="" type="checkbox"/>	0 (off)	10,00	0,01	s	0 (off)

The HSP5 Watchdog-function monitors the communication of the HSP5-interface (control card - operator; or control card - PC). After expiration of an adjustable time (0,01...10 s) without incoming telegrams, the response adjusted in Pn.5 is triggered. The value „off“ deactivates the function.

Sy. 11 Baud rate int. bus									
Adr.									
000Bh	<input checked="" type="checkbox"/>	<input type="checkbox"/>	<input checked="" type="checkbox"/>	3	11	1	-	5

With the internal baudrate the transmission rate between operator and inverter is determined. Following values are possible:

Value	Baudrate	Value	Baudrate	Value	Baudrate
3	9,6 kBaud	6	55,5 kBaud	9	115,2 kBaud
4	19,2 kBaud	7	57,6 kBaud	10	125 kBaud
5	38,4 kBaud	8	100 kBaud	11	250 kBaud

Sy. 32 Scope Timer									
Adr.									
0020h	<input type="checkbox"/>	<input type="checkbox"/>	<input type="checkbox"/>	0	65535	1	-	0

The scope timer generates a time period of 1 ms. This can be used by external programs, e.g. Scope, to represent time patterns. The timer counts from 0...65535 and starts again with 0 after an overflow.

Sy. 41 Control word high									
Adr.									
0029h	<input checked="" type="checkbox"/>	<input type="checkbox"/>	<input checked="" type="checkbox"/>	0	65535	1	-	0

The control word is used for the status control of the inverter via bus. The control word long (Sy.43) consists of the two 16 bit parameters control word high (Sy.41) and Control word low (Sy.50). The status word is bit-coded. The description of the individual bits is found in Chapter 11.2.7.

Sy. 42 Status word high									
Adr.									
002Ah	<input type="checkbox"/>	<input type="checkbox"/>	<input type="checkbox"/>	0	65535	1	-	0

With the status word the current condition of the inverter can be readout. The status word long (Sy.44) consists of the two 16 bit parameters status word high (Sy.42) and status word low (Sy.51). The status word is bit-coded. The description of the individual bits is found in Chapter 11.2.7.

Sy. 43 Control word long									
Adr.									
002Bh	<input checked="" type="checkbox"/>	<input type="checkbox"/>	<input checked="" type="checkbox"/>	-2147483648	2147483647	1	-	0
<p>The control word is used for the status control of the inverter via bus. The control word long (Sy.43) consists of the two 16 bit parameters control word high (Sy.41) and Control word low (Sy.50). The status word is bit-coded. The description of the individual bits is found in Chapter 11.2.7.</p>									

Sy. 44 Status word long									
Adr.									
002Ch	<input type="checkbox"/>	<input type="checkbox"/>	<input type="checkbox"/>	-2147483648	2147483647	1	-	0
<p>With the status word the current condition of the inverter can be readout. The status word long (Sy.44) consists of the two 16 bit parameters status word high (Sy.42) and status word low (Sy.51). The status word is bit-coded. The description of the individual bits is found in Chapter 11.2.7.</p>									

Sy. 50 Control word									
Adr.									
0032h	<input checked="" type="checkbox"/>	<input type="checkbox"/>	<input checked="" type="checkbox"/>	0	65535	1	-	0
<p>The control word is used for the status control of the inverter via bus. The control word long (Sy.43) consists of the two 16 bit parameters control word high (Sy.41) and Control word low (Sy.50). Das Steuerwort ist bitcodiert. The status word is bit-coded. The description of the individual bits is found in Chapter 11.2.7.</p>									

Sy. 51 Status word									
Adr.									
0033h	<input type="checkbox"/>	<input type="checkbox"/>	<input type="checkbox"/>	0	65535	1	-	0
<p>With the status word the current condition of the inverter can be readout. The status word long (Sy.44) consists of the two 16 bit parameters status word high (Sy.42) and status word low (Sy.51). Das Steuerwort ist bitcodiert. The status word is bit-coded. The description of the individual bits is found in Chapter 11.2.7.</p>									

Sy. 52 Set speed value									
Adr.									
0034h	<input checked="" type="checkbox"/>	<input type="checkbox"/>	<input type="checkbox"/>	-16000	16000	1	rpm	0
<p>Presetting of the setpoint speed in the range of ±16000 rpm. The source of direction of rotation is determined as with the other absolute setpoint sources over oP.1. The setpoint source oP.0 must be adjusted to „5“ for setpoint setting by Sy.52.</p>									

Sy. 53 Actual speed value									
Adr.									
0035h	<input type="checkbox"/>	<input type="checkbox"/>	<input type="checkbox"/>	-16000	16000	1	rpm	0
With this parameter the current actual speed can be readout in rpm. The direction of rotation is signaled by the sign.									

Sy. 56 Start display address									
Adr.									
0038h	<input checked="" type="checkbox"/>	<input type="checkbox"/>	<input checked="" type="checkbox"/>	0	7FFF	1	hex	0203
Sy.56 adjusts the parameter address which shall be represented on switching on the operator. Only valid addresses are accepted. If this parameters is available in the CP-Mode, the setting becomes effective there. Otherwise CP.0 is indicated as start parameter.									

1. Introduction

2. Summary

3. Hardware

4. Operation

5. Parameter

6. Functions

7. Start-up

8. Special Operation

9. Error Assistance

10. Project Planning

11. Networks

12. Annex

6.1 Operating and Appliquence
Date

6.2 Analog In- and Outputs

6.3 Digital In- and Outputs

6.4 Set Value and Ramp
Adjustment

6.5 Voltage-/Frequency
Characteristic (U/f)
Adjustment

6.6 Motor Data Adjustment

6.7 Protective Functions

6.8 Parameter Sets

6.9 Special Functions

6.10 Encoder Interface

6.11 SMM, Posi, Synchron

6.12 Technology Control

6.13 CP-Parameter Definition

6.2.1 Summary Description

Analog Inputs 3

6.2.2 Interface Selection 4

6.2.3 Interference Suppression Filter 5

6.2.4 Save mode 5

6.2.5 Input selection 5

6.2.6 Zero point hysteresis 6

6.2.7 Amplifier of the Input

Characteristic 7

6.2.8 Lower and Upper Limit 8

6.2.9 Selection Set Point-/
Auxiliary Input 9

6.2.10 Summary Description

Analog Outputs 10

6.2.11 Output Signals 11

6.2.12 Analog Output / Functions 11

6.2.13 Analog Output / Display 11

6.2.14 Amplifier of the Output

Characteristic 11

6.2.15 Period ANOUT3 13

6.2.16 Digital Settings 13

6.2.17 Used Parameters 14

Chapter 6	Section 2	Page 2	Date 12.04.02	Name: Basis KEB COMBIVERT F5	© KEB Antriebstechnik, 2002 All rights reserved
---------------------	---------------------	------------------	------------------	--	--

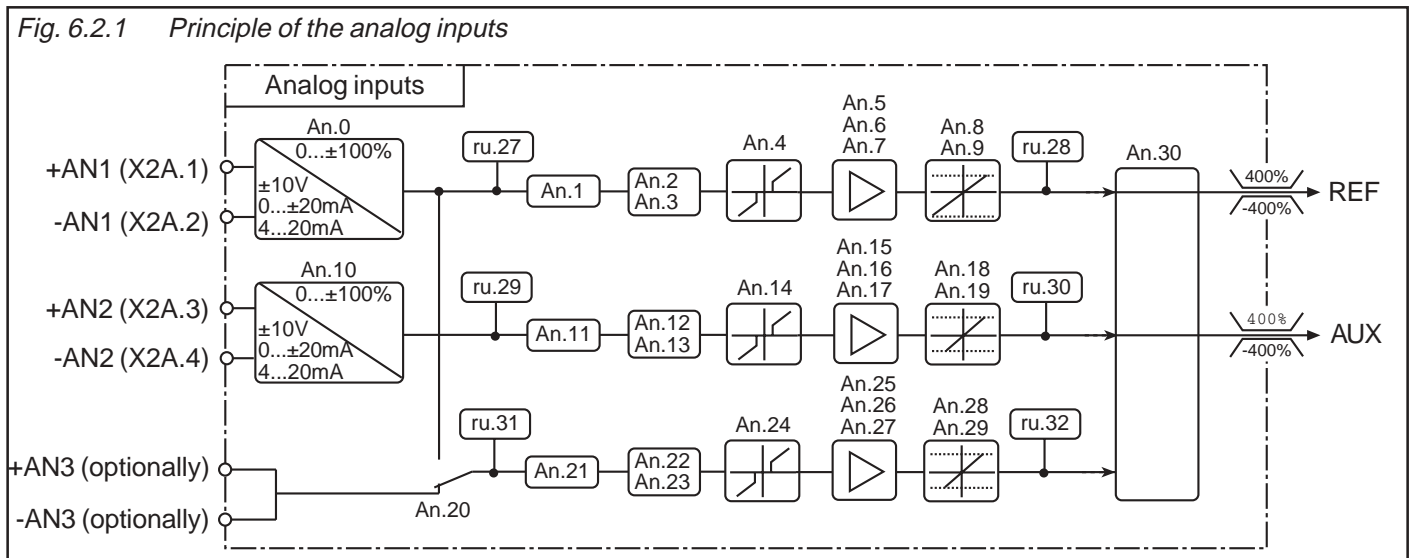
6.2 Analog In- and Outputs

6.2.1 Summary Description Analog Inputs

! *Observe the different functional range of the hard- and software of the different control cards (see chapter 3).*

By selecting an input interface (An.0 / 10) input AN1, e.g. AN2 can be adjusted to the applied input signal. By An.20 the third analog input can be switched additionally to AN1. Subsequently the analog inputs are smoothed in an electronic filter (An.1 / 11 / 21) by averaging. With An.2 / 12 / 22 a save mode can be adjusted and activated with a programmable input (An.3 / 13 / 23). To avoid voltage fluctuations and ripple voltages around the zero point the analog signal can be faded out around the zero point up to $\pm 10\%$ (An.4 / 14 / 24). In the characteristics amplifier the input signals can be influenced in X and Y direction as well as in the rise (An.5...7 / 15...17 / 25...27). At the output of the characteristic amplifier the signal can be limited to a minimum and a maximum value (An.8, 9 / 18, 19 / 28, 29). At the output of the block it can be defined with An.30 which analog signal serves as reference value and which one serves as auxiliary value. The ru-parameters are used for the indication of the analog signal before and after the amplification. The internal values are limited to $\pm 400\%$.

Fig. 6.2.1 Principle of the analog inputs



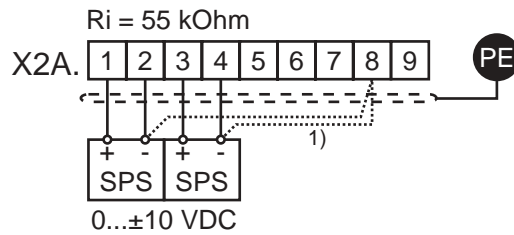
An. 0	AN1 Interface selection	An. 19	AN2 Upper limit
An. 1	AN1 Interference suppression filter	An. 20	AN3 Interface selection
An. 2	AN1 Save mode	An. 21	AN3 Interference suppression filter
An. 3	AN1 Input selection	An. 22	AN3 Save mode
An. 4	AN1 Zero point hysteresis	An. 23	AN3 Input selection
An. 5	AN1 Amplification	An. 24	AN3 Zero point hysteresis
An. 6	AN1 Offset X	An. 25	AN3 Amplification
An. 7	AN1 Offset Y	An. 26	AN3 Offset X
An. 8	AN1 Lower limit	An. 27	AN3 Offset Y
An. 9	AN1 Upper limit	An. 28	AN3 Lower limit
An. 10	AN2 Interface selection	An. 29	AN3 Upper limit
An. 11	AN2 Interference suppression filter	An. 30	Selection REF-input / AUX-function
An. 12	AN2 Save mode	ru. 27	AN1 Display before amplification
An. 13	AN2 Input selection	ru. 28	AN1 Display after amplification
An. 14	AN2 Zero point hysteresis	ru. 29	AN2 Display before amplification
An. 15	AN2 Amplification	ru. 30	AN2 Display after amplification
An. 16	AN2 Offset X	ru. 31	AN3 Display before amplification
An. 17	AN2 Offset Y	ru. 32	AN3 Display after amplification
An. 18	AN2 Lower limit		

6.2.2 Interface Selection (An.0; An.10)

Depending on the selected interface (An.0/An.10) the analog inputs AN1 and AN2 can process following input signals:

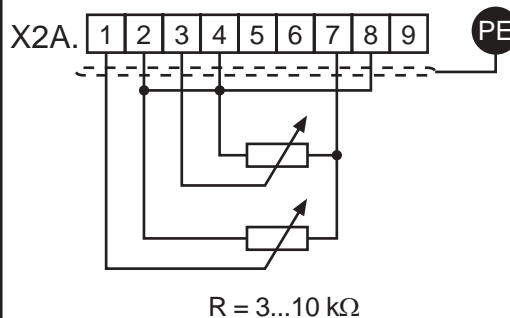
- An.0 / An.10 = 0 0...±10 V (default)
- = 1 0...±20 mA
- = 2 4...20 mA

Fig. 6.2.2.a Connection as differential voltage inputs 0...±10V DC



1) Connect equipotential bonding conductor only, if a potential difference of > 30V exists between the controls. The internal resistance is reduced to 30 kOhm.

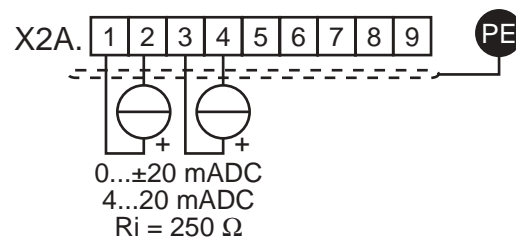
Fig. 6.2.2.b Control with potentiometer and internal reference voltage



0...10V DC
 Ri=30kΩ
 (An.0 / An.10 = 0)

The output CRF KI. X2A.7 may be loaded with maximal 6mA!

Fig. 6.2.2.c Control with current signal



An.0 / An.10 = 1 or 2

0...±20 mADC
 4...20 mADC
 Ri = 250 Ω

Interface Selection (An.20)

With An.20 it is determined from where the 3. analog setpoint signal is received. Following values can be defined:

Value	Function
0	Analog value from the optional analog input (default)
1	Analog value via the terminals of AN1

6.2.3 Interference Suppression Filter (An.1; An.11; An.21)

The interference suppression filters shall suppress disturbances and ripples of the input signals. If the interference suppression filter is switched off the analog inputs are queried every 1 ms (control card BASIC 2 ms) and the recorded value is then transferred. With the interference suppression filters the inputs can now be queried 2-, 4-, 8- or 16-times. From these values an average value is determined which is then transferred.

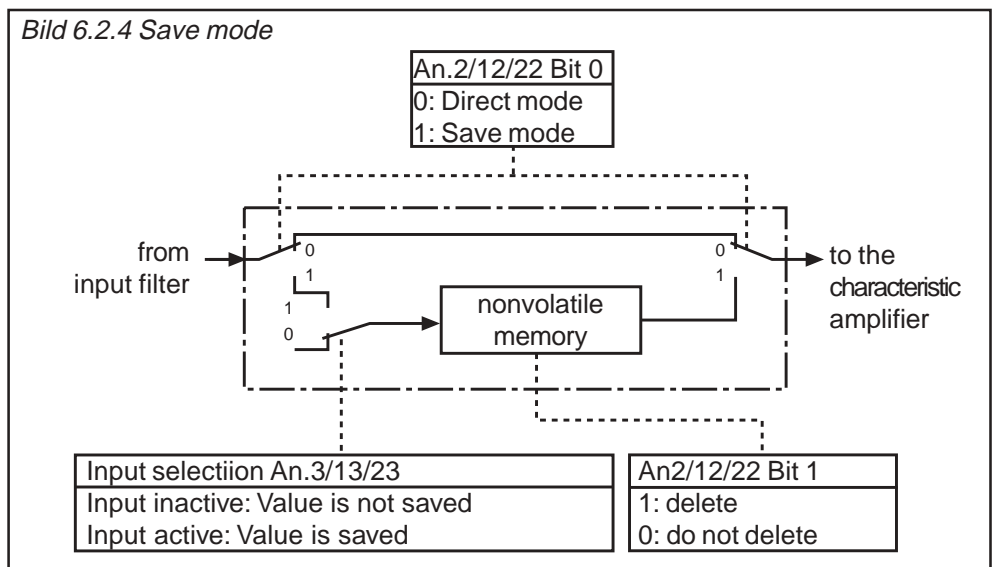
An.1 / 11 / 21	Function
0	no averaging (default)
1	averaging over 2 values
2	averaging over 4 values
3	averaging over 8 values
4	averaging over 16 values

6.2.4 Save Mode (An.2; An.12; An.22)

Coming from the input filter the save mode can be switched on with An.2 / An.12 / An.22. If now the programmable digital input (value 1) is set the analog signal is processed directly and written parallel into the nonvolatile memory. As soon as the digital input is disconnected (value 0), the inverter continuous to run with value stored in the memory. Moreover, with An.2 / An.12 / An.22 it can be determined whether the memory contents are saved or deleted upon switch off. The parameter is bit-coded, the sum of the decimal values must be entered.

Bit	Dez.	Meaning
0	0	Direct mode (default)
	1	Save mode
1	0	Do not delete memory contents at switch off (default)
	2	Delete memory contents at switch off

Bild 6.2.4 Save mode



6.2.5 Input Selection (An.3; An.13; An.23)

With An.3 / 13 / 23 the digital inputs for storing are selected according to the table on the next page (also see Chapter 6.3.11 „Assignment of inputs“). In order to save an analog value, the save mode (An.2 / 12 / 22 = 1) must be switched on under An2 / 12 / 22 and the selected input must be activated.

Input selection table

Bit -No.	Decimal value	Input	Terminal
0	1	ST (prog. input „control release/Reset“)	X2A.16
1	2	RST (prog. input „Reset“)	X2A.17
2	4	F (prog. input „forward“)	X2A.14
3	8	R (prog. input „reverse“)	X2A.15
4	16	I1 (prog. input 1)	X2A.10
5	32	I2 (prog. input 2)	X2A.11
6	64	I3 (prog. input 3)	X2A.12
7	128	I4 (prog. input 4)	X2A.13
8	256	IA (internal input A)	none
9	512	IB (internal input B)	none
10	1024	IC (internal input C)	none
11	2048	ID (internal input D)	none

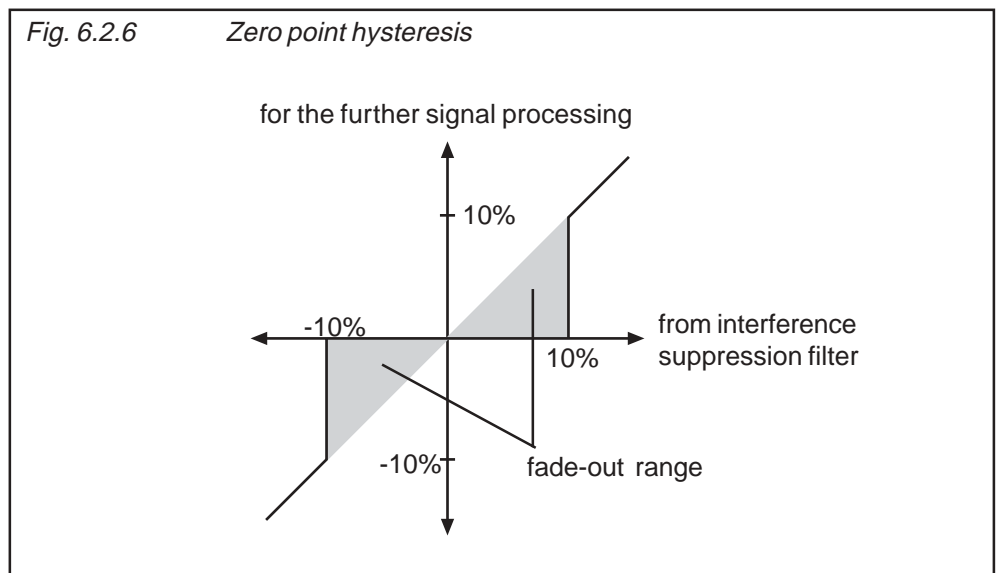
6.2.6 Zero Point Hysteresis (An.4; An.14; An.24)

Through capacitive as well as inductive coupling on the input lines or voltage fluctuations of the signal source, the motor connected to the inverter can still drift (tremble) during standstill in spite of the analog input filter. It is the task of the zero point hysteresis to suppress this.

With the parameters An.4 / 14 / 24 the respective analog signals can be faded out within a range of 0...10% . The adjusted value is applicable for both directions of rotation.

If a negative percent value is adjusted the hysteresis acts in addition to the zero point around the current setpoint. Setpoint changes are accepted only if they are larger than the adjusted hysteresis.

Fig. 6.2.6 Zero point hysteresis



Value range

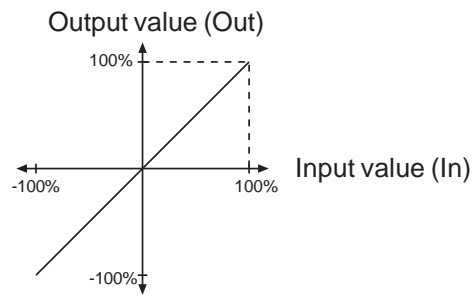
Input	Parameter	Value range	Resolution	Default value
AN1	An.4	0...±10%	0,1%	0,2%
AN2	An.14	0...±10%	0,1%	0,2%
AN3	An.24	0...±10%	0,1%	0,2%

6.2.7 Amplifier of the Input Characteristic (An.5...7; An.15...17; An.25...27)

With these parameters the input signals can be adapted in X and Y direction as well as in the rise to the requirements. In the case of factory setting no zero point offset is adjusted, the rise (gain) is 1, i.e. the input value corresponds to the output value of this step (see Fig. 6.2.7.a) The output value is calculated according to following formula:

$$\text{Out} = \text{Amplification} \cdot (\text{In} - \text{Offset X}) + \text{Offset Y}$$

Fig. 6.2.7.a Factory setting: no Offset, Gain 1

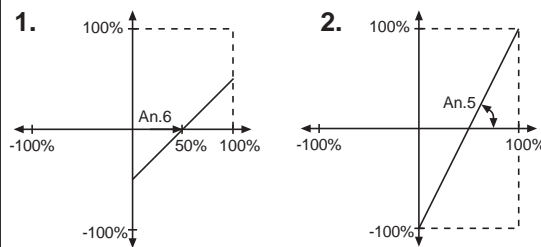


Input	AN1	AN2	AN3	Value range	Resolution	Default value
Amplification	An.5	An.15	An.25	-20,00...20,00	0,01	1,00
Offset X	An.6	An.16	An.26	-100,0%...100,0%	0,1%	0,0%
Offset Y	An.7	An.17	An.27	-100,0%...100,0%	0,1%	0,0%

By means of some examples, we want to show the possibilities of this function. According to Fig. 6.2.7.b

1. adjustment of the X-Offset for input AN1 to 50 (%)
2. adjustment of the amplification to 2

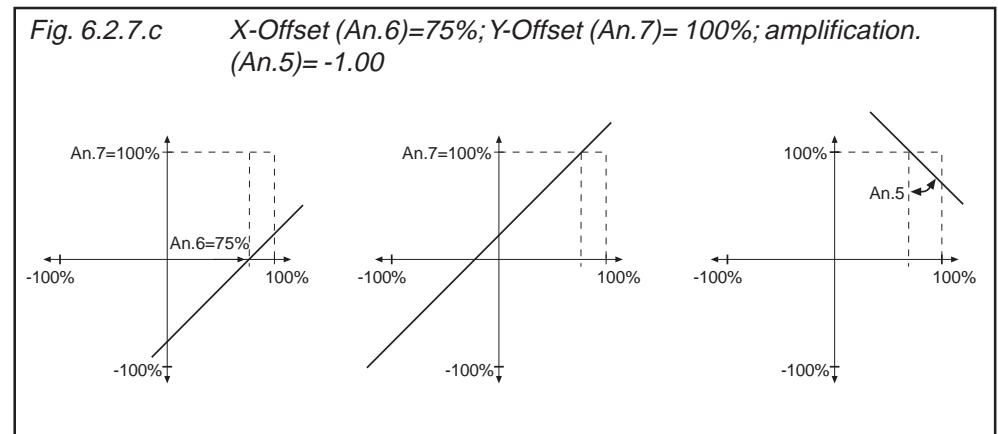
Fig. 6.2.7.b X-Offset (An.6)=50%; amplification (An.5)=2.00



With these settings the entire speed range can be driven with 0...10 V via input AN1.
(rotation direction = ±analog)
0% In corresponds to -100% Out
50% In corresponds to 0% Out
100% In corresponds to 100% Out

According to Fig. 6.2.7.c

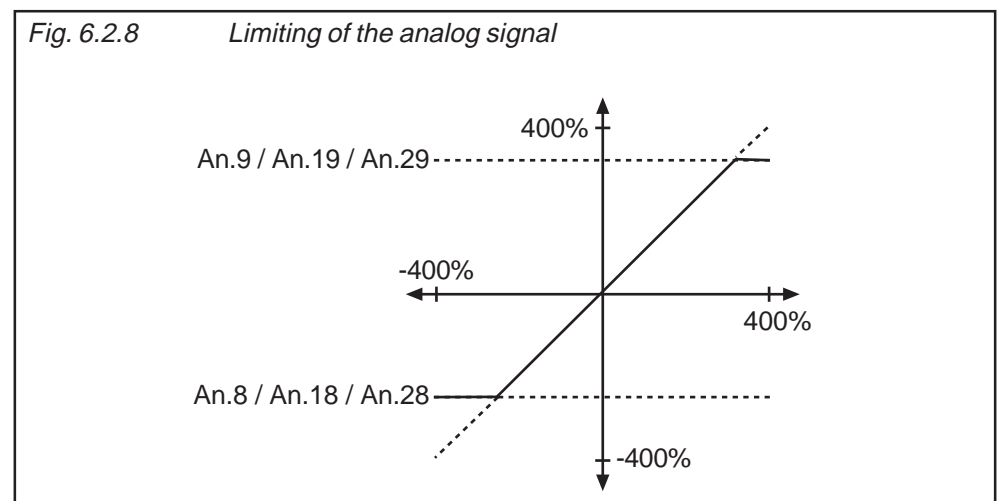
1. adjustment of the X-Offset for input AN1 to 75 (%)
2. adjustment of the Y-Offset for input AN1 to 100 (%)
3. adjustment of the amplification to -1



6.2.8 Lower and Upper Limit (An.8; An.9; An.18; An.19; An.28; An.29)

These parameters serve for the limiting of the analog signals after the amplifier stage. All parameters are adjustable in the range of -400...400 %. Since no mutual locking exists, it is to be ensured, that the lower limit is adjusted smaller than the upper limit (exception F5-M: if lower limit > upper limit then the output value is the lower limit).

- An.8 AN1 lower limit
- An.9 AN1 upper limit
- An.18 AN2 lower limit
- An.19 AN2 upper limit
- An.28 AN3 lower limit
- An.29 AN3 upper limit



6.2.9 Selection Set Point-/Auxiliary Input (An.30)

Following functions are combined in An.30:

- Bit 0..2 Selection of the analog input (AN1, AN2, AN3) as REF analog
- Bit 3..5 Mode of the AUX-Function
- Bit 6..10 Selection source 1 for the AUX-Function
- Bit 11..15 Selection source 2 for the AUX-Function

For possible expansions not all values are defined in the bit groups. Not defined values have the same function as value 0. The sum of the respective values is to be entered.

Assignment of the analog inputs:

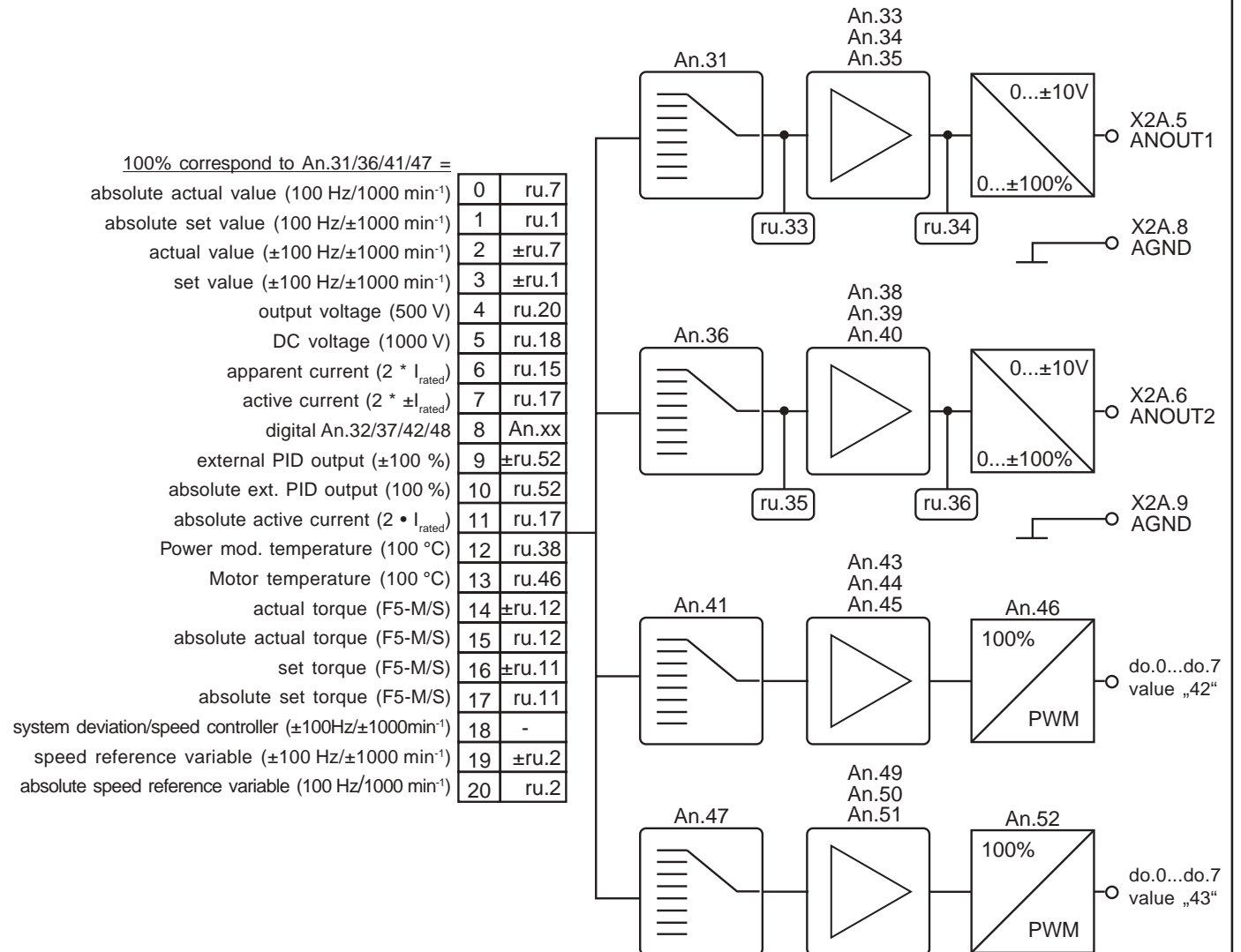
Bit 0..2 Value	Function REF analog	
0	AN1 (ru.28) (default)	
1	AN2 (ru.30)	x
2	AN3 (ru.32)	x
Bit 3..5 Value	Function Mode of the AUX-Function	
0	Source 1 (default)	
8	Source 1 + Source 2	
16	Source 1 * (100% + Source 2)	
24	Source1 * Source 2	
Bit 6..10 Value	Function Aux-input source 1	
0	AN1 (ru.28)	
64	AN2 (ru.30) (default)	x
128	Percental setpoint value (op.5)	
192	Motorpoti (ru.37)	
256	Process controller output (ru.52)	
320	AN3 (ru.32)	x
Bit 11..15 Value	Function Aux-input source 2	
0	AN1 (ru.28)	
2048	AN2 (ru.30) (default)	x
4096	Percental setpoint value (op.5)	
6144	Motorpoti (ru.37)	
8192	Process controller output (ru.52)	
11240	AN3 (ru.32)	x

x: not for control card BASIC

**6.2.10 Brief Description
Analog Outputs**

The KEB COMBIVERT has three programmable analog outputs (ANOUT1...4). Parameters An.31 and An.36 allow the selection of one size each which is given out at the outputs X2A.5 / 6. The third and fourth analog output (An.41/47) is not led to the terminal strip, it can be output as switching condition 42, e.g. 43 with the digital outputs as PWM-signal. By means of the characteristic amplifier (An.33...35 / 38...40 / 43...45 / 49...51) the analog signals can be adapted to the requirements. The ru-parameters show the current size before and after the amplification. The period time for the PWM-signal can be adjusted with An.46/52.

Fig. 6.2.10 Principle of analog output



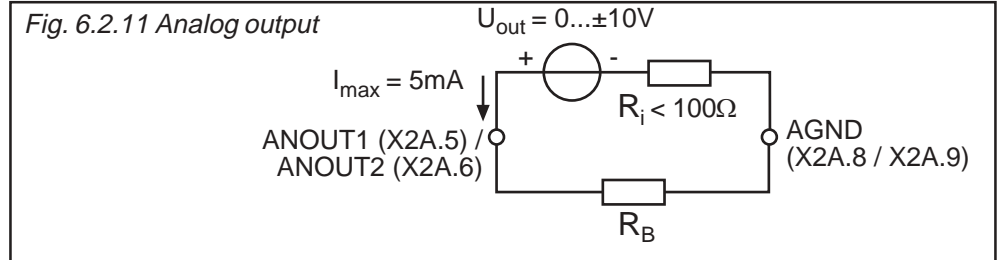
Observe the different functional range of the hard- and software of the different control cards!
The reference values of real and set values depends on ud.2.

100% correspond to An.31/36/41/47 =

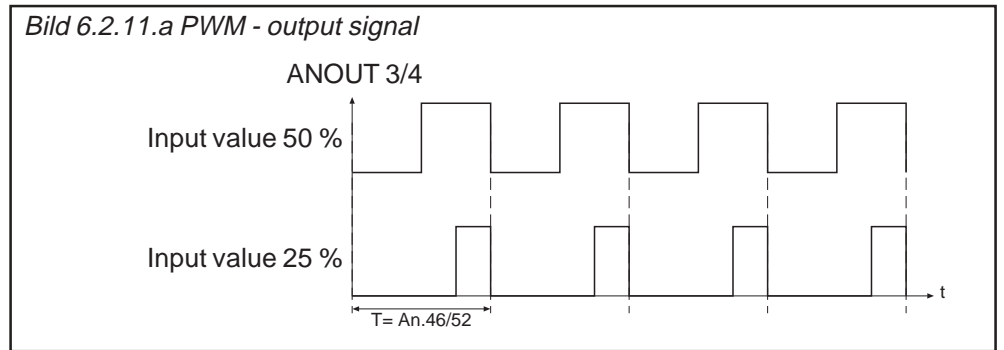
0	ru.7
1	ru.1
2	±ru.7
3	±ru.1
4	ru.20
5	ru.18
6	ru.15
7	ru.17
8	An.xx
9	±ru.52
10	ru.52
11	ru.17
12	ru.38
13	ru.46
14	±ru.12
15	ru.12
16	±ru.11
17	ru.11
18	-
19	±ru.2
20	ru.2

6.2.11 Output signals

A voltage of 0...±11,5 VDC represents the selected size in the range of 0...±115 % with a resolution of ±10 Bit at the output. 100% correspond to the bracket values specified in Fig. 6.2.10. In order to be able to balance load-dependent voltage drops, the limitation at the output of the characteristic amplifiers is ±115 %.



Process variables, that change only slowly, as for example the power module temperature, can be output over two virtual analog outputs (ANOUT3 and 4). This is realised through generation of a PWM-signal (pulse-width-modulation) on a digital output. At that the period T is adjustable from 1...240 s.



6.2.12 Analog Output / Functions (An.31/An.36/An.41)

These parameters define the function which controls the respective output. Following adjustments are possible:

An.xx	Function	Scaling factor 0...100 %
0	absolute actual value	0...100 Hz/1000 min ^{-1 2)}
1	absolute set value	0...100 Hz/1000 min ^{-1 2)}
2	actual value ru.7	0...±100 Hz/±1000 min ^{-1 2)}
3	set value ru.1	0...±100 Hz/±1000 min ^{-1 2)}
4	output voltage ru.20	0...500 V
5	DC voltage ru.18	0...1000 V
6	apparent current ru.15	0...2 • I _{rated} ¹⁾
7	active current ru.17	0...2 • ±I _{rated} ¹⁾
8	digital An.32/An.37/An.42	0...100 %
9	external PID output ru.52	0...±100 %
10	absolute ext. PID output ru.52	0...100 %
11	absolute active current ru.17	0...2 • I _{rated} ¹⁾
12	power mod. temperature ru.38	0...100°C
13	Motor temperature ru.46	0...100°C
14	actual torque (F5-M/S)	0...± 3 • rated torque
15	absolute actual torque (F5-M/S)	0...3 • rated torque
16	set torque (F5-M/S)	0...± 3 • rated torque
17	absolute set torque (F5-M/S)	0...3 • rated torque
18	system deviation/speed controller	0...±100 Hz/±1000 min ^{-1 2)}
19	speed reference variable ru.2	0...±100 Hz/±1000 min ^{-1 2)}
20	absolute speed reference variable ru.2	0...100 Hz/1000 min ^{-1 2)}

¹⁾ dependent of inverter rated current (In.1) ²⁾ dependent of ud.2

6.2.13 Analog Output / Display

Following parameters are used for the indication of the analog outputs, before and after the characteristic amplification:

ru.33 ANOUT1 pre ampl. display	0...±400 %
ru.34 ANOUT1 post ampl. display	0...±115 %
ru.35 ANOUT2 pre ampl. display	0...±400 %
ru.36 ANOUT2 post ampl. display	0...±115 %

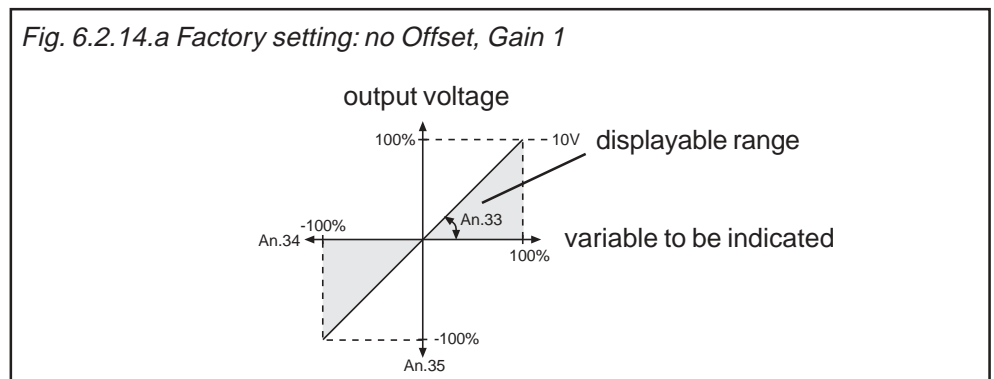
At the outputs ANOUT 3 and 4 there is no display provided.

6.2.14 Gain of Output Characteristic (An.33...35 / An.38...40 / An.43...45)

After selecting the signal to be given out it can be adapted to the requirements by means of characteristic amplifier in X/Y-direction or gain. With factory setting no zero point offset is adjusted, the gain is 1, i.e. 100% of the variable to be given out correspond to 10V at the analog output (see Fig. 6.2.14.a).

Function	ANOUT1	-2	-3	-4	Value range	Resolution	Default
Gain	An.33	An.38	An.43	An.49	±20,00	0,01	1,00
X-Offset	An.34	An.39	An.44	An.50	±100,0%	0,1%	0,0%
Y-Offset	An.35	An.40	An.45	An.51	±100,0%	0,1%	0,0%

Fig. 6.2.14.a Factory setting: no Offset, Gain 1

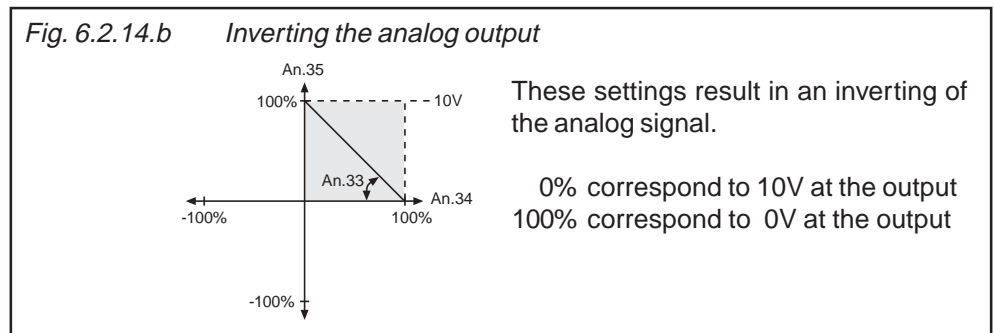


Inverting the analog output

An example for using the characteristic amplifier is shown in Fig. 6.2.14.b:

1. adjustment of the X-Offset (An.34) to 100 (%)
2. adjustment of the amplification (An.33) to -1.00

Fig. 6.2.14.b Inverting the analog output

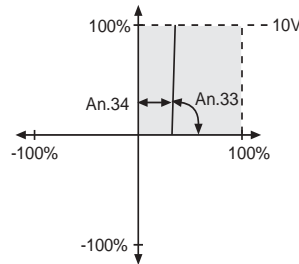


These settings result in an inverting of the analog signal.

0% correspond to 10V at the output
100% correspond to 0V at the output

Analog output as switch An example for using the analog output as 0/10V-switch is shown in Fig. 6.2.14.c:
 1. adjustment of the amplification (An.33) to 20.00
 2. adjustment of the X-Offset (An.34) to the desired switching level

Fig. 6.2.14.c Analog output as switch



Because of the high amplification the analog output switches in a relative small switching window.

Computation of the amplification Since the analog output always works firmly onto the values defined under 6.2.10, one can adjust the characteristic with the aid of the amplification so that the complete range of 0...±10V is utilized.

$$\frac{\text{defined value}}{\text{desired value}} = \text{Amplification (An.33 / 38 / 43 / 49)}$$

Example output frequency

$$\frac{100\text{Hz}}{68\text{Hz}} = 1,47$$









6.2.15 Period ANOUT3 (An.46)





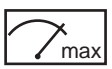



The amount of the selected process variable (An.41/47) is converted into a percentage. The output of the characteristic amplifier (An.43...45 / An.49...51) is limited to values from 0...100 %. The multiplication of the base value with the cycle duration (An.46 / 52) results in the ON period of the digital output (selection in do.0..7 value „42/43“). The period can be adjusted in a range from 1...240 s.









6.2.16 ANOUT 1...4 Digital Settings (An.32/37/42/48)

With these parameters analog values can be adjusted in percent for the respective input. For that purpose the value „8 digital setting“ must be adjusted as process variable. The setting is done within the range ±100 %.

6.2.17 Used Parameters

Param.	Adr.								
ru.1	0201h	-	-	-	-400 Hz	400 Hz	0,0125 Hz	-	resolution and value range see ud.2
ru.2	0202h	-	-	-	-400 Hz	400 Hz	0,0125 Hz	-	resolution and value range see ud.2
ru.7	0207h	-	-	-	-400 Hz	400 Hz	0,0125 Hz	-	resolution and value range see ud.2
ru.15	020Fh	-	-	-	0 A	6553,5 A	0,1 A	-	-
ru.17	0211h	-	-	-	-3276,7 A	3276,7 A	0,1 A	-	-
ru.18	0212h	-	-	-	0 V	1000 V	1 V	-	-
ru.20	0214h	-	-	-	0 V	778 V	1 V	-	-
ru.27	021Bh	-	-	-	-100,0 %	100,0 %	0,1 %	-	-
ru.28	021Ch	-	-	-	-400,0 %	400,0 %	0,1 %	-	-
ru.29	021Dh	-	-	-	-100,0 %	100,0 %	0,1 %	-	-
ru.30	021Eh	-	-	-	-400,0 %	400,0 %	0,1 %	-	-
ru.31	021Fh	-	-	-	-100,0 %	100,0 %	0,1 %	-	-
ru.32	0220h	-	-	-	-400,0 %	400,0 %	0,1 %	-	-
ru.33	0221h	-	-	-	-400,0 %	400,0 %	0,1 %	-	-
ru.34	0222h	-	-	-	-100,0 %	100,0 %	0,1 %	-	-
ru.35	0223h	-	-	-	-400,0 %	400,0 %	0,1 %	-	-
ru.36	0224h	-	-	-	-100,0 %	100,0 %	0,1 %	-	-
ru.38	0226h	-	-	-	0 °C	150 °C	1 °C	-	-
ru.46	022Fh	-	-	-	0 °C	255 °C	1 °C	-	0; 253...255 see description
ru.52	0234h	-	-	-	-100,0 %	100,0 %	0,1 %	-	-
An.0	0A00h	✓	-	✓	0	2	1	0	-
An.1	0A01h	✓	-	✓	0	4	1	0	-
An.2	0A02h	✓	-	✓	0	3	1	0	-
An.3	0A03h	✓	-	✓	0	4095	1	0	-
An.4	0A04h	✓	-	-	-10,0 %	10,0 %	0,1 %	0,2 %	-
An.5	0A05h	✓	✓	-	-20,00	20,00	0,01	1,00	-
An.6	0A06h	✓	✓	-	-100,0 %	100,0 %	0,1 %	0,0 %	-
An.7	0A07h	✓	✓	-	-100,0 %	100,0 %	0,1 %	0,0 %	-
An.8	0A08h	✓	✓	-	-400,0 %	400,0 %	0,1 %	-400,0 %	-
An.9	0A09h	✓	✓	-	-400,0 %	400,0 %	0,1 %	400,0 %	-
An.10	0A0Ah	✓	-	✓	0	2	1	0	-
An.11	0A0Bh	✓	-	✓	0	4	1	0	-
An.12	0A12h	✓	-	✓	0	3	1	0	-
An.13	0A13h	✓	-	✓	0	4095	1	0	-

Param.	Adr.								
An.14	0A0Eh	✓	-	-	0,0 %	10,0 %	0,1 %	0,2 %	-
An.15	0A0Fh	✓	✓	-	-20,00	20,00	0,01	1,00	-
An.16	0A10h	✓	✓	-	-100,0 %	100,0 %	0,1 %	0,0 %	-
An.17	0A11h	✓	✓	-	-100,0 %	100,0 %	0,1 %	0,0 %	-
An.18	0A12h	✓	✓	-	-400,0 %	400,0 %	0,1 %	-400,0 %	-
An.19	0A13h	✓	✓	-	-400,0 %	400,0 %	0,1 %	400,0 %	-
An.20	0A14h	✓	-	✓	0	1	1	0	-
An.21	0A15h	✓	-	✓	0	4	1	0	-
An.22	0A16h	✓	-	✓	0	3	1	0	-
An.23	0A17h	✓	-	✓	0	4095	1	0	-
An.24	0A18h	✓	-	-	-10,0 %	10,0 %	0,1 %	0,2 %	-
An.25	0A19h	✓	✓	-	-20,00	20,00	0,01	1,00	-
An.26	0A1Ah	✓	✓	-	-100,0 %	100,0 %	0,1 %	0,0 %	-
An.27	0A1Bh	✓	✓	-	-100,0 %	100,0 %	0,1 %	0,0 %	-
An.28	0A1Ch	✓	✓	-	-400,0 %	400,0 %	0,1 %	-400,0 %	-
An.29	0A1Dh	✓	✓	-	-400,0 %	400,0 %	0,1 %	400,0 %	-
An.30	0A1Eh	✓	✓	✓	0	12287	1	2112	-
An.31	0A1Fh	✓	✓	✓	0	12	1	2	-
An.32	0A20h	✓	✓	-	-100,0 %	100,0 %	0,1 %	0,0 %	-
An.33	0A21h	✓	✓	-	-20,00	20,00	0,01	1,00	-
An.34	0A22h	✓	✓	-	-100,0 %	100,0 %	0,1 %	0,0 %	-
An.35	0A23h	✓	✓	-	-100,0 %	100,0 %	0,1 %	0,0 %	-
An.36	0A24h	✓	✓	✓	0	12	1	6	-
An.37	0A25h	✓	✓	-	-100,0 %	100,0 %	0,1 %	0,0 %	-
An.38	0A26h	✓	✓	-	-20,00	20,00	0,01	1,00	-
An.39	0A27h	✓	✓	-	-100,0 %	100,0 %	0,1 %	0,0 %	-
An.40	0A28h	✓	✓	-	-100,0 %	100,0 %	0,1 %	0,0 %	-
An.41	0A29h	✓	✓	✓	0	12	1	12	-
An.42	0A2Ah	✓	✓	-	-100,0 %	100,0 %	0,1 %	0,0 %	-
An.43	0A2Bh	✓	✓	-	-20,00	20,00	0,01	1,00	-
An.44	0A2Ch	✓	✓	-	-100,0 %	100,0 %	0,1 %	0,0 %	-
An.45	0A2Dh	✓	✓	-	-100,0 %	100,0 %	0,1 %	0,0 %	-
An.46	0A2Eh	✓	✓	✓	1 s	240 s	1 s	1 s	-
An.47	0A2Fh	✓	✓	✓	0	20	1	12	-
An.48	0A30h	✓	✓	-	-100,0 %	100,0 %	0,1 %	0,0 %	-

Param.	Adr.								
An.49	0A31h	✓	✓	-	-20,00	20,00	0,01	1,00	-
An.50	0A32h	✓	✓	-	-100,0 %	100,0 %	0,1 %	0,0 %	-
An.51	0A33h	✓	✓	-	-100,0 %	100,0 %	0,1 %	0,0 %	-
An.52	0A34h	✓	✓	✓	1 s	240 s	1 s	1 s	-

1. Introduction

2. Summary

3. Hardware

4. Operation

5. Parameter

6. Functions

7. Start-up

8. Special Operation

9. Error Assistance

10. Project Planning

11. Networks

12. Annex

6.1 Operating and Appearance Date

6.2 Analog In- and Outputs

6.3 Digital In- and Outputs

6.4 Set Value and Ramp Adjustment

6.5 Voltage-/Frequency Characteristic (U/f) Adjustment

6.6 Motor Data Adjustment

6.7 Protective Functions

6.8 Parameter Sets

6.9 Special Functions

6.10 Encoder Interface

6.11 SMM, Posi, Synchron

6.12 Technology Control

6.13 CP-Parameter Definition

6.3.1 Summary Description

6.3.1.1 Digital Inputs 3

6.3.2 Input Signals 3

6.3.3 Setting of Digital Inputs by Software 4

6.3.4 Terminal Status 5

6.3.5 Digital Filter 5

6.3.6 Inversion of Inputs 5

6.3.7 Edge-triggering 5

6.3.8 Strobe-dependent Inputs 6

6.3.9 Inputs Status 8

6.3.10 Reset/Input Selection and Edge Evaluation 8

6.3.11 Assignment of the Inputs 8

6.3.12 Summary Description

6.3.12.1 Digital Outputs 11

6.3.13 Output Signals 12

6.3.14 Output filter 12

6.3.15 Switching Conditions 13

6.3.16 Inverting of Switching Conditions for Flags 16

6.3.17 Selection of Switching Conditions for Flags 16

6.3.18 Linking the Switching Conditions for Flags 16

6.3.19 Inverting of Flags 17

6.3.20 Selection of Flags 17

6.3.21 Linking the Flags 17

6.3.22 Inversion of Outputs 18

6.3.23 Output Terminal Status 18

6.3.24 Example 19

6.3.25 Used Parameters 20

Chapter 6	Section 3	Page 2	Date 16.04.02	Name: Basis KEB COMBIVERT F5	© KEB Antriebstechnik, 2002 All rights reserved
---------------------	---------------------	------------------	------------------	--	--

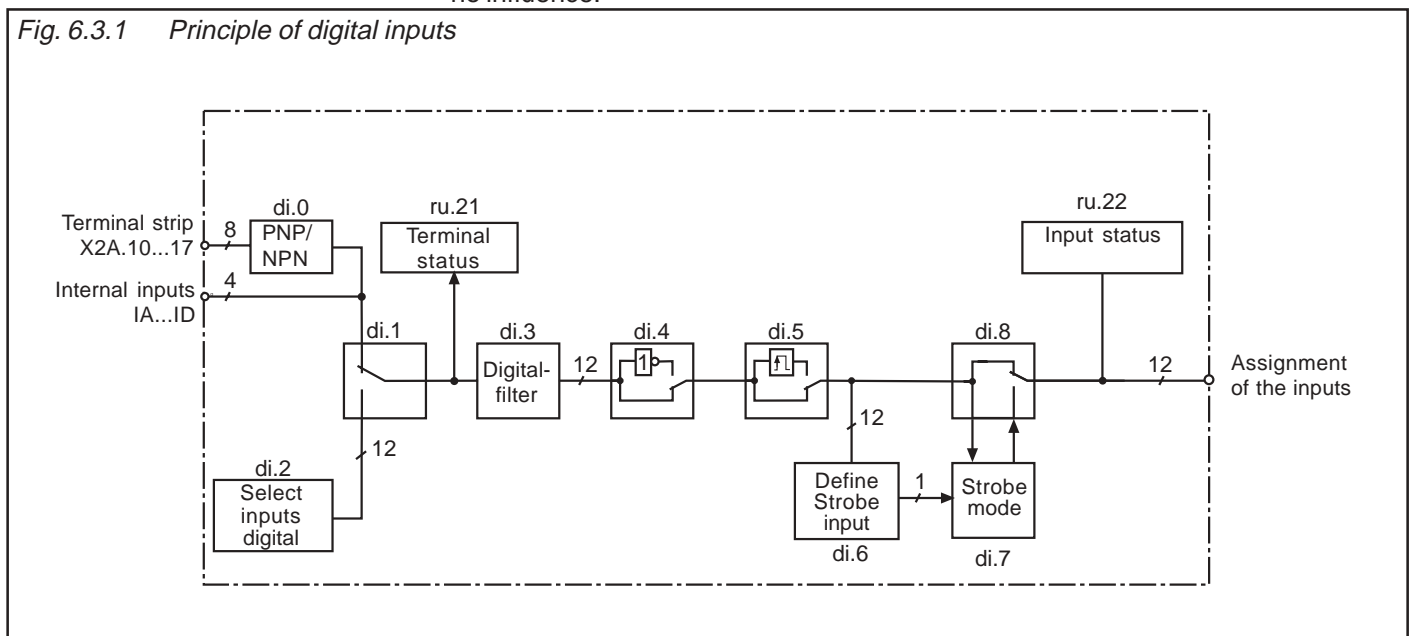
6.3 Digital In- and Outputs

6.3.1 Summary Description Digital Inputs

! Observe the different functional range of the hard- and software of the different control cards (see chapter 3).

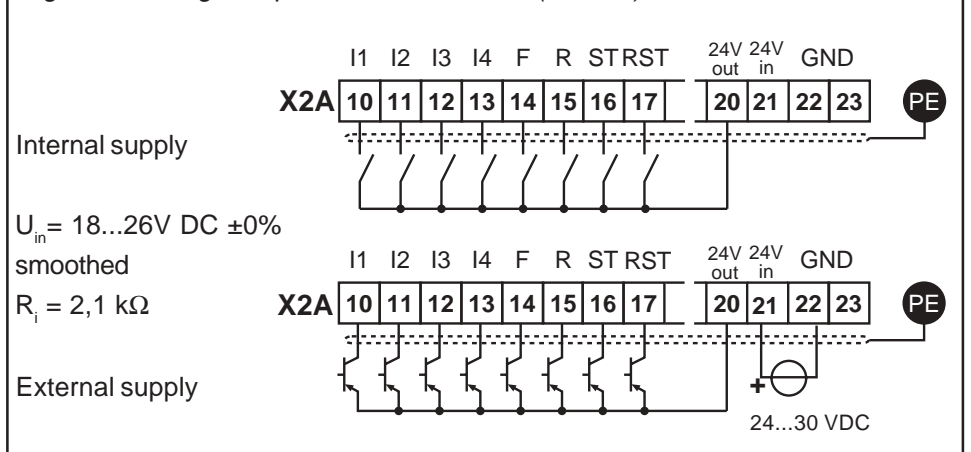
The KEB COMBIVERT has 8 external digital inputs and 4 internal inputs (IA...ID). All inputs can be assigned to one or several functions. Coming from the terminal strip it can be defined with parameter di.0 (not at F5-B), whether external inputs shall be controlled in PNP or NPN (not at safety relais) wiring. Parameter ru.21 shows the currently controlled input. Each input can optionally (di.1) be set via terminal strip or by means of software with di.2. A digital filter (di.3) reduces the interference susceptibility of the inputs. The inputs can be inverted with di.4 and with di.5 one can switch to edge-triggering. With the parameters di. 6...di. 8 a Strobe-mode can be activated. The input status (ru.22) shows the inputs that are actually set for processing. The function(s), that a programmed input carries out, is defined by means of the input selection of the corresponding function or by di.11...22. For safety reasons the control release (ST) must generally be switched by means of hardware. Edge-triggering, inversion and strobe signal can be adjusted but have no influence.

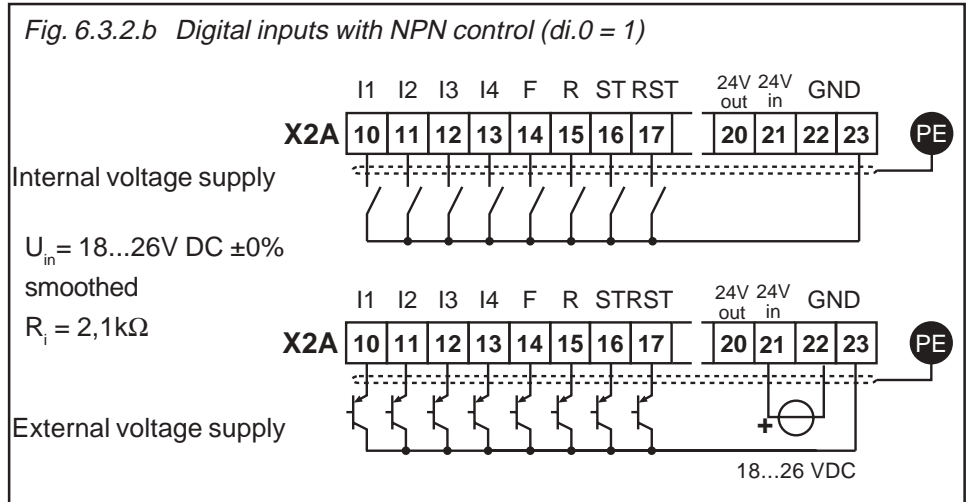
Fig. 6.3.1 Principle of digital inputs



6.3.2 Input Signals PNP / NPN (di.0)

Fig. 6.3.2.a Digital inputs with PNP control (di.0 = 0)

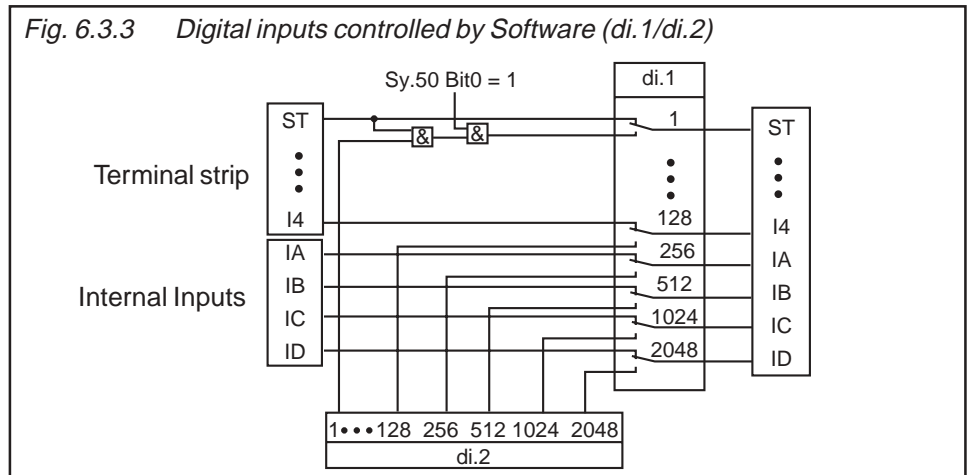




6.3.3 Setting of Digital Inputs by Software (di.1, di.2)

! The control release must generally be switched by means of hardware even if one switches by software (see Fig. 6.3.3 AND-operation with di.2 and Sy.50)!

With the aid of parameter di.1 and di.2 the digital input can be set without external wiring.



As shown in Fig. 6.3.3, it can be selected with di.1, whether the inputs shall be switched from the terminal strip (default) or by way of parameter di.2. Both parameters are bit-coded, i.e. according to following table, the appropriate value for the input is to be entered. In the case of several inputs the sum is to be formed. (Exception: Control release must always be bridged at the terminal strip).

Bit -No.	Decimal value	Input	Terminal
0	1	ST (Prog. input „Control release/Reset“)	X2A.16
1	2	RST (Prog. input „Reset“)	X2A.17
2	4	F (Prog. input „Forward“)	X2A.14
3	8	R (Prog. input „Reverse“)	X2A.15
4	16	I1 (Prog. input 1)	X2A.10
5	32	I2 (Prog. input 2)	X2A.11
6	64	I3 (Prog. input 3)	X2A.12
7	128	I4 (Prog. input 4)	X2A.13
8	256	IA (Internal input A)	none
9	512	IB (Internal input B)	none
10	1024	IC (Internal input C)	none
11	2048	ID (Internal input D)	none

6.3.4 Terminal Status (ru.21)

The terminal status shows the logic level on the input terminals. It is unimportant, whether the inputs are internally active or not. If a terminal is controlled, then the appropriate decimal value according to the table below is output. If several terminals are active, then the sum of the decimal values is output.

Bit -No.	Decimal value	Input	Terminal
0	1	ST (Prog. input „Control release/Reset“)	X2A.16
1	2	RST (Prog. input „Reset“)	X2A.17
2	4	F (Prog. input „Forward“)	X2A.14
3	8	R (Prog. input „Reverse“)	X2A.15
4	16	I1 (Prog. input 1)	X2A.10
5	32	I2 (Prog. input 2)	X2A.11
6	64	I3 (Prog. input 3)	X2A.12
7	128	I4 (Prog. input 4)	X2A.13
8	256	IA (Internal input A)	none
9	512	IB (Internal input B)	none
10	1024	IC (Internal input C)	none
11	2048	ID (Internal input D)	none

Example: ST, F and IB are controlled ⇨ indicated value = 1+4+512 = **517**

6.3.5 Digital Filter (di.3)

The digital filter reduces the susceptibility to interferences on the digital inputs. With di.3 a response time is adjusted. For the duration of the adjusted time the conditions of **all** inputs must remain constant, so that a transfer occurs. The transfer takes place at the positive edge of the scanning grid (see Fig. 6.3.7).

Parameter	Setting range	Response time
di.3	0...127	(adjusted value +1) x program run time

Program run time: 1 ms at F5-General; 2 ms at F5-Basic

6.3.6 Inversion of Inputs (di.4)

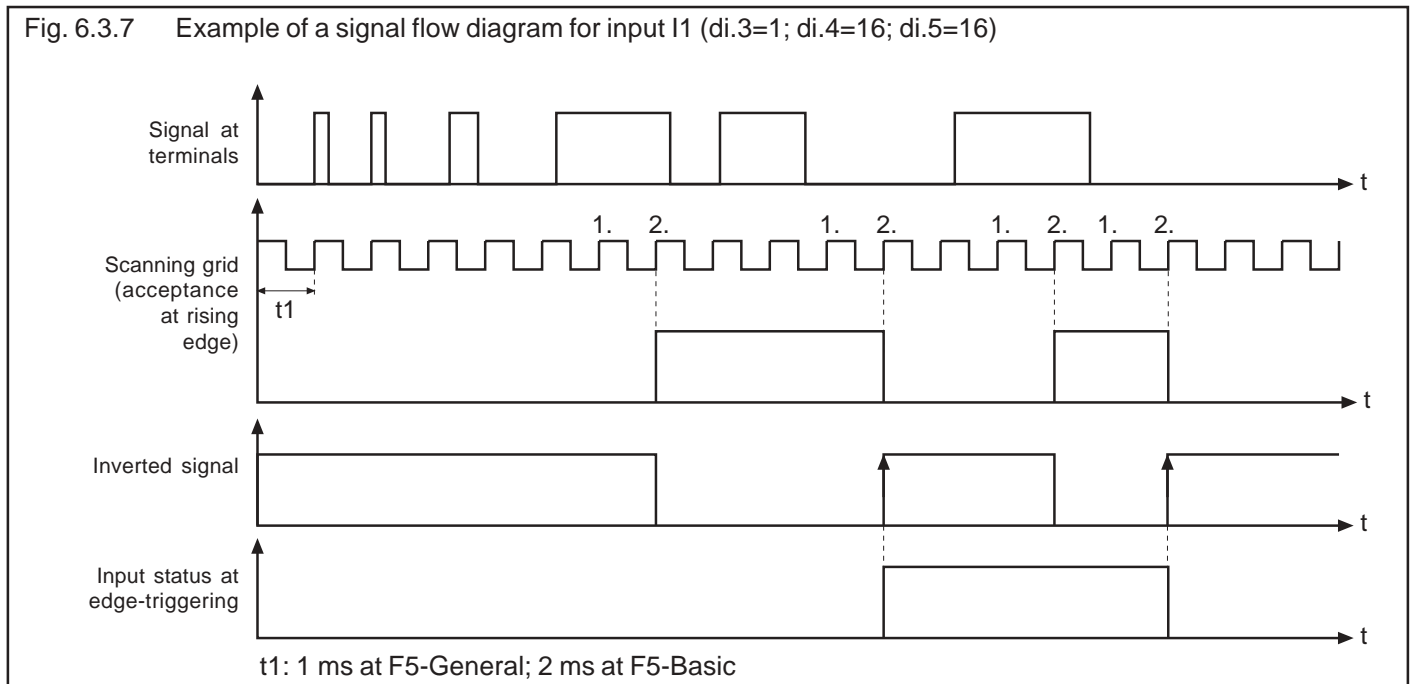
With parameter di.4 it can be adjusted, whether a signal is 1- or 0-active (inverted). The parameter is bit-coded, i.e. according to the table below, the appropriate value for the input is to be entered. If several inputs shall be inverted, then the sum is to be formed. (Exception: An inversion of the control release remains without function).

6.3.7 Edge-triggering (di.5)

As a standard the inverter is controlled with static signals, i.e. an input is set for as long as a signal is applied. However, practice has shown that a signal may be available for a limited time only, but the input shall still remain set. In that case the input or several inputs can be adjusted to edge-triggering. Then a rising edge with a pulse duration that is longer than the response time of the digital filter is sufficient for switch-on. Switch-off is effected with the next rising edge.

Control release (ST) can be set to edge-triggering, but remains without affect on the function, since it is a pure static signal.

Bit -No.	Decimal value	Input	Terminal
0	1	ST (Prog. input „Control release/Reset“)	X2A.16
1	2	RST (Prog. input „Reset“)	X2A.17
2	4	F (Prog. input „Forward“)	X2A.14
3	8	R (Prog. input „Reverse“)	X2A.15
4	16	I1 (Prog. input 1)	X2A.10
5	32	I2 (Prog. input 2)	X2A.11
6	64	I3 (Prog. input 3)	X2A.12
7	128	I4 (Prog. input 4)	X2A.13
8	256	IA (Internal input A)	none
9	512	IB (Internal input B)	none
10	1024	IC (Internal input C)	none
11	2048	ID (Internal input D)	none



6.3.8 Strobe-dependent Inputs (di.6, di.7, di.8)

A Strobe signal is used mainly for triggering the input signals. For example, two inputs shall be used for the parameter set selection. But the signals for the control do not arrive exactly even, so for a short time it would be switched into an unintended set. With active Strobe (scanning signal) the current input signals of the Strobe-dependent inputs are accepted and kept until the next scanning.

Which inputs are switched by Strobe?

With di.8 any input can be selected as Strobe-dependent input. With the control release di.8 has no function since this is a static input.

From where comes the Strobe signal?

With parameter di.6 the Strobe input is set. If several inputs are adjusted as Strobe they are linked in **OR-operation**. At the next rising edge of the clock signal, the Strobe signal is triggered.

di.8 Strobe-dependent inputs
di.6 Selection strobe signal

Bit -No.	Decimal value	Function di.6 / di.8 / ru.22 / di.9 / di.10	Terminal
0	1 *	ST (Prog. input „Control release/Reset“)	X2A.16
1	2	RST (Prog. input „Reset“)	X2A.17
2	4	F (Prog. input „Forward“)	X2A.14
3	8	R (Prog. input „reverse“)	X2A.15
4	16	I1 (Prog. input 1)	X2A.10
5	32	I2 (Prog. input 2)	X2A.11
6	64	I3 (Prog. input 3)	X2A.12
7	128	I4 (Prog. input 4)	X2A.13
8	256	IA (Internal input A)	none
9	512	IB (Internal input B)	none
10	1024	IC (Internal input C)	none
11	2048	ID (Internal input D)	none

* No function at di.8, as the control release works static.

Edge-active or static Strobe? As a standard the Strobe is edge-active, i.e. the input conditions on the Strobe input are accepted with rising edge and maintained until the next edge. For some applications it is sensible to use the Strobe in a manner of a gate function. In that case the Strobe signal is static, i.e. the input signals are accepted for as long as the Strobe signal is set (or for as long as the gate is open).

di.7 Strobe-mode

Parameter	Setting range	Function
di.7	0	edge-active Strobe (default)
	1	static strobe - frooze if strobe is not activ
	2	static strobe - only activ at activ strobe

Fig. 6.3.8.a Edge-active Strobe (di.7=0)

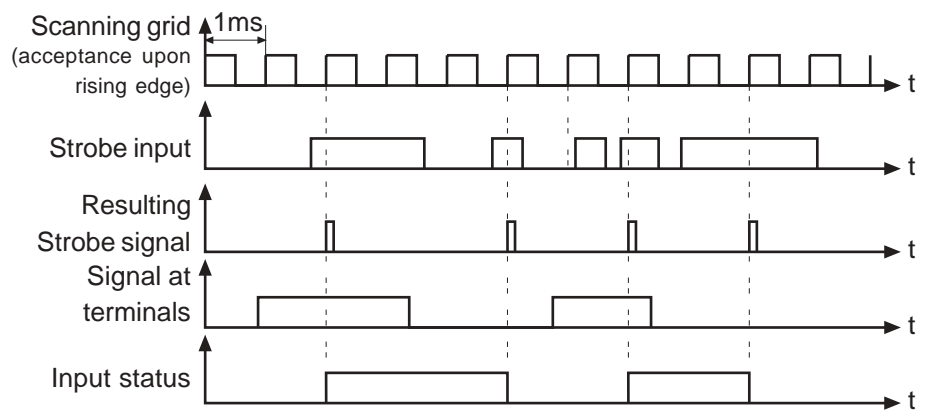


Fig. 6.3.8.b Static Strobe Mode 1 (di.7=1)

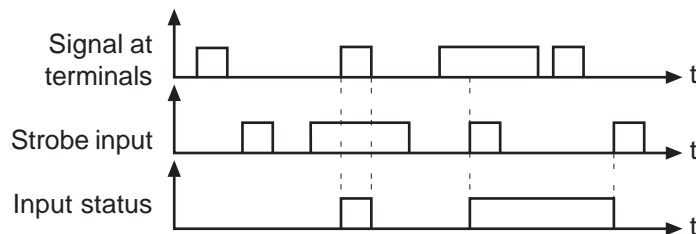
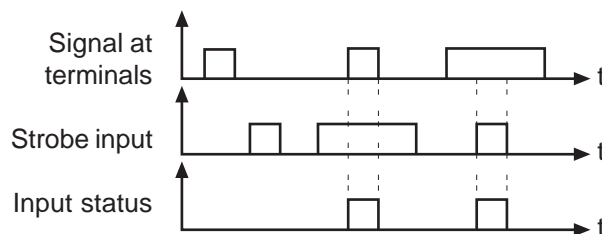


Fig. 6.3.8.c Static Strobe Mode 2 (di.7=2)



6.3.9 Input Status (ru.22)

The internal input status shows the logic condition of the digital inputs which are internally set for processing. It is unimportant, whether the external terminals are active or not. If an input is set, the appropriate decimal value according to the table under 6.3.8 is output. If several inputs are set, then the sum of the decimal values is output.

6.3.10 Reset/Input Selection and Edge Evaluation (di.9 / di.10)

With di.9 the reset input is defined according to the table under 6.3.8. If the reset input shall react to an edge, one or several of the reset inputs defined with di.9 can be switched to edge evaluation with di.10.

6.3.11 Assignment of the Inputs

There are two different procedures for the assignment of inputs. Both variants are locked against each other to give the user maximum flexibility.

List of parameters, that can be assigned with inputs:

Parameter	Name	Preadjustment
oP.19	Fixed value / input selection 1	16 (I1)
oP.20	Fixed value / input selection 2	32 (I2)
oP.56	Motorpoti increase / input selection	0
oP.57	Motorpoti decrease / input selection	0
oP.58	Motorpoti Reset / input selection	0
oP.60 ¹⁾	Rotation forward (Run) / input selection	4 (F)
oP.61 ¹⁾	Rotation reverse (Stop) / input selection	8 (R)
di. 9	Reset / input selection	3 (ST+RST)
di.10 ²⁾	Edge evaluation for Reset / input selection	3 (ST+RST)
Pn. 4	External fault / input selection	64 (I3)
Pn.23	Ramp stop / input selection	0
Pn.29	DC-braking / input selection	128 (I4) 0 at F5-M
uF. 8	Energy-saving function / input selection	0
Fr. 7	Parameter set / input selection	0
Fr.11	Reset set / input selection	0
An. 3	AN1 save trigger / input selection	0
An.13	AN2 save trigger / input selection	0
An.23	AN3 save trigger / input selection	0
LE.17	Timer 1 Start / input selection	0
LE.19	Timer 1 Reset / input selection	0
LE.22	Timer 2 Start / input selection	0
LE.24	Timer 2 Reset / input selection	0
cn.11	PID reset / input selection	0
cn.12	I reset / input selection	0
cn.13	Fade in reset / input selection	0

¹⁾ By selecting the source of rotation (oP.1) the adjustment can be changed from forward/reverse to Run/Stop.

²⁾ see chapter 6.3.10

• **Input-related assignment**

A parameter is assigned to each input (di.11...22) which adjusts the desired function(s).

The appropriate function is determined by the input of the decimal value. If several functions should be selected, then the sum of the decimal values must be entered.

Fig. 6.3.11a Input-related assignment

Input	Parameter	Function
		2^0 oP.19 1
		2^1 oP.20 2
		2^2 oP.56 4
		2^3 oP.57 8
I1	di.11	2^4 oP.58 16
		2^5 oP.60 32
I2	di.12	2^6 oP.61 64
		2^7 di. 9 128
I3	di.13	2^8 Pn.23 256
		2^9 Pn.29 512
I4	di.14	2^{10} uF. 8 1.024
		2^{11} Fr. 7 2.048
IA	di.15	2^{12} Fr.11 4.096
		2^{13} Pn. 4 8.192
IB	di.16	2^{14} An. 3 16.384
		2^{15} An.13 32.768
IC	di.17	2^{16} An.23 65.536
		2^{17} LE.17 131.072
ID	di.18	2^{18} LE.19 262.144
		2^{19} LE.22 524.288
F	di.19	2^{20} LE.24 1.048.576
		2^{21} cn.11 2.097.152
R	di.20	2^{22} cn.12 4.194.304
		2^{23} cn.13 8.388.608
RST	di.21	* 2^{24} PS.2 16.777.216
		* 2^{25} PS.3 32.554.432
ST	di.22	* 2^{26} PS.18 67.108.864
		* 2^{27} PS.19 134.217.728
		2^{28} Pn.64 268.435.456
		* 2^{29} PS.29 536.870.912
		* 2^{30} PS.10 1.073.741.824

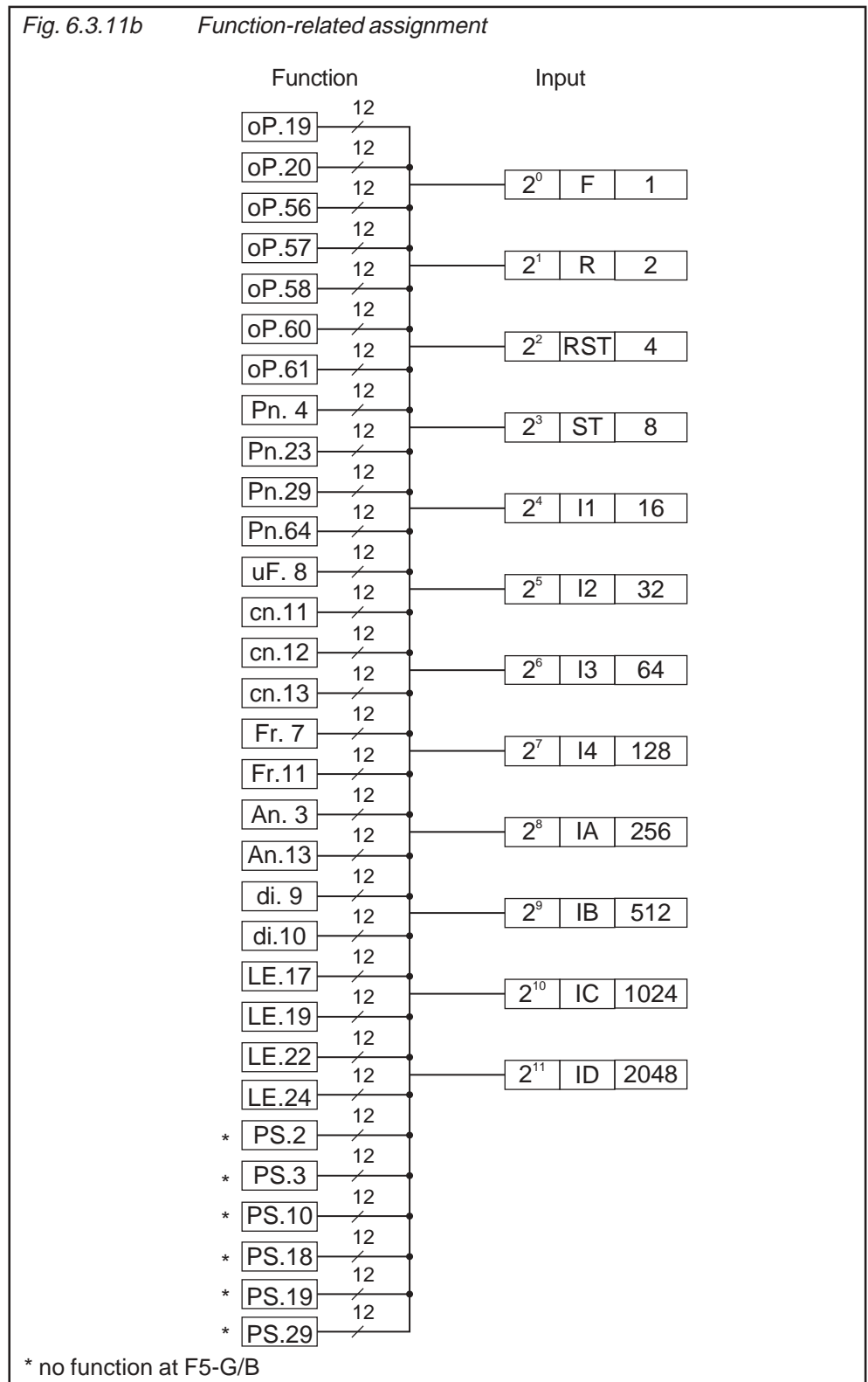
* no function at F5-G/B

The input ST is assigned by hardware means with the function „control release“. Further functions can be adjusted only „additionally“.

• **Function-related assignment**

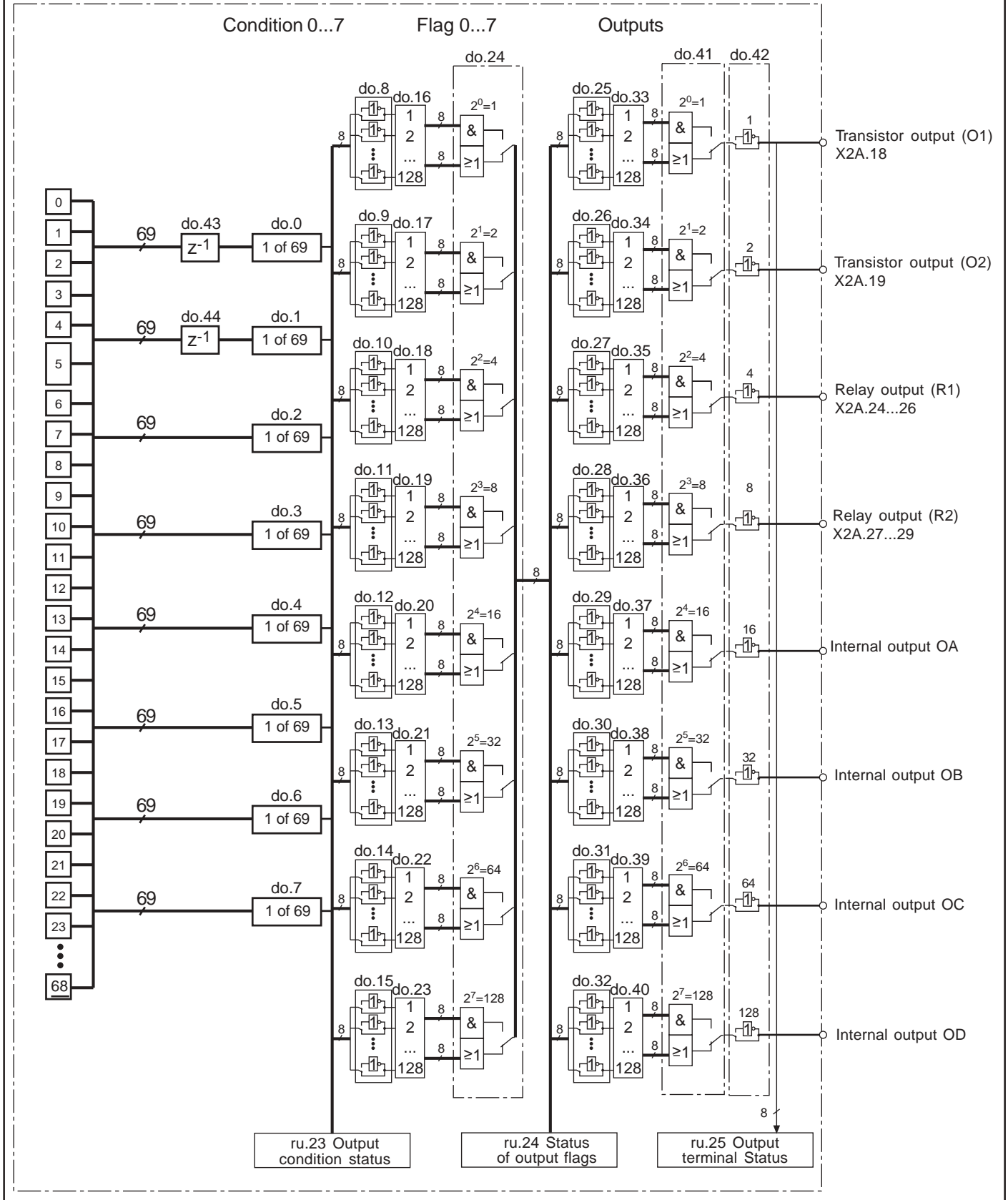
A parameter is assigned to each function which adjusts the desired input(s). The appropriate input is determined by the input of the decimal value. If several inputs should be selected, then the sum of the decimal values must be entered.

Fig. 6.3.11b Function-related assignment



6.3.12 Summary Description - Digital Outputs

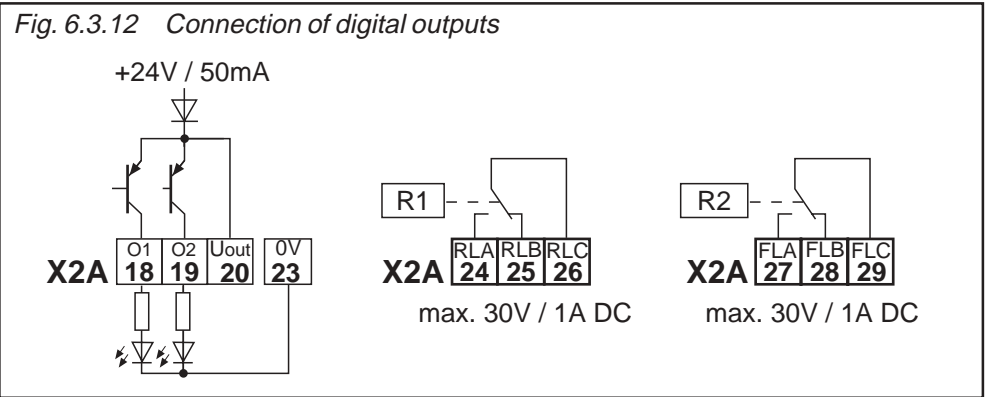
Fig. 6.3.12 Principle of digital outputs



Description For the switching of the digital outputs one can choose up to 8 conditions from the 69 different conditions. These are entered in do.0...do.7. Switching condition 0 and 1 can be filtered by do.43 and do.44. Parameter ru.23 shows, if one or several of these conditions are met. For each channel it can now be selected which of the 8 conditions shall apply to it (do.16...do.23). Each condition can still be inverted before selection (do.8...do.15). As a standard all conditions (if several are selected) are OR-operated, i.e. if one of the selected conditions is fulfilled, the channel is set. With do.24 this can be changed to AND-operation, i.e. all conditions selected for this channel must be fulfilled before it is set. Parameter ru.24 shows the channels which are set in this stage. do.33...40 form a second logic step with which a selection of the channels from logic step 1 can be made. Every individual condition can be inverted with do.25...32. do.41 adjusts the manner of the linkage (AND/OR). Parameter do.42 is used for inverting one or several outputs. ru.25 is used to indicate the outputs switched real or through inversion. The internal outputs OA...OD are directly connected with the internal inputs IA...ID.

6.3.13 Output Signals

! The total current of X2A.18...20 is limited to 50mA. In case of inductive load at the relay outputs or at the transistor output a **protective wiring** is to be provided (free-wheeling diode)!



6.3.14 Output filter (do.43, do.44)

With do.43 a filter can be set for switching condition 0, with do.44 for switching condition 1. The change of a switching condition must be applied for the filter time, then it becomes active at the output of the filter. If the change of a switching condition is cancelled during the filter time, the filter time is reset and restarted at the next change. The filter time is adjustable within the range of 0 (off)...1000 ms.

6.3.15 Switching Conditions (do.0...do.7)

From the following switching conditions one can select up to 8 for further processing. The values are then entered in the parameters do.0...do.7.

Value	Function
0	Off
1	Always active
2	Run signal; also at DC-braking
3	Ready for operation; if no fault exists (ru.0 <> error)
4	Fault relay trips, when the inverter is switched off with an error
5	Fault relay, as at 2, but not for errors which are reset automatically with activated „Auto-restart-function“
6	Warning or error signal is given, when the inverter fulfills an abnormal-stopping condition (ru.0).
7	Overload-prewarning! ru.39 is an overload counter, that counts in steps of 1%. On reaching 100 % the inverter switches off. Upon exceeding the level of Pn.9 (default 80%) the overload warning is given. The performance in case of an warning can be adjusted with Pn.8 (response to OL-warning)
8	Overheating-prewarning (OH)! Depending on the power circuit the inverter switches off between 60...95°C power module temperature. The prewarning is output, when the level OH-warning (Pn.11) is reached (default 70°C). The behaviour in case of an warning can be adjusted with Pn.10 (response to OH-warning).
9	PTC-prewarning (dOH), on tripping of the motor-PTC connected to the terminals T1/T2. After expiration of an adjustable switch-off time Pn.13 (0...120s) the inverter switches off. the behaviour in case of an error can be adjusted with Pn.12 (response to dOH-warning).
10	Motor protection prewarning (OH2), if the motor protection triggering time defined according to VDE has expired. The response to the warning can be adjusted with Pn.14 (response to motor protective function)(see Chapter 6.7 „Motor protective function“).
11	Interior temperature-prewarning (OHI) is output, when the interior temperature of the inverter exceeds the level OHI-warning (Pn.17). The behaviour in case of an error can be adjusted with Pn.16 (response to OHI-warning). Not at Pn.16 = 7
12	Cable breakage at 4...20mA setpoint adjustment at AN1; Trips, if the setpoint current drops below 2mA (An.0 = 2).
13	Cable breakage at 4...20mA setpoint adjustment at AN2; Trips, if the setpoint current drops below 2mA (An.10 = 2).
14	Max. constant current (Stall) exceeded (Pn.17). See chapter 6.7 „Constant current limit“.
15	Ramp stop function active (LA-/LD-Stop), current (Pn.22) or voltage (Pn.23) exceeded during acceleration/ deceleration. See chapter 6.7 „Ramp stop“.
16	DC-braking active; see chapter 6.9 „DC-brake“
17	Power-Off function active (see chapter 6.9 „Power-Off“), in case of an error or SSF the condition is not fulfilled
18	Brake control is set, when the brake shall be released (see chapter 6.9 „Brake control“)
19	Control difference > level
20	Actual value = setpoint at constant run; not at ru.0 = noP, LS, Error or SSF.
21	Inverter is in the acceleration phase, at ru.0 = FAcc, rAcc and LAS (acceleration stop)
22	Inverter is in the deceleration phase, at ru.0 = Fdec, rdec and LDS (deceleration stop)
23	Actual direction of rotation = set direction of rotation
24	Utilization (ru.13) > level
25	Active current (ru.17) > level
26	DC-link voltage > level
27	Actual value (ru.7) > level
28	Setpoint value (ru.1) > level
29	Ref. point run completed (only F5-M/S)
30	Actual torque > level (only F5-M/S)
31	AN1 on output of characteristic amplifier > level; without sign evaluation
32	AN2 on output of characteristic amplifier > level; without sign evaluation

33	AN3 on output of characteristic amplifier > level; without sign evaluation																										
34	AN1 on output of characteristic amplifier > level; with sign evaluation																										
35	AN2 on output of characteristic amplifier > level; with sign evaluation																										
36	AN3 on output of characteristic amplifier > level; with sign evaluation																										
37	Timer 1 > level																										
38	Timer 2 > level																										
39	Angle difference > level (only F5-M/S)																										
40	Hardware current limit active																										
41	Modulation on-signal																										
42	Output of analog signal ANOUT3 as PWM-signal. The period is adjusted with An.46.																										
43	Output of analog signal ANOUT4 as PWM-signal. The period is adjusted with An.52.																										
44	Inverter state (ru.0) = Level																										
45	Power module temperatur (ru.38) > Level																										
46	Motor temperatur (ru.46) > Level																										
47	Ramp output value (ru.2) > Level																										
48	Apparent current (ru.15) > Level																										
49	Clockwise rotation (not at noP, LS, abnormal stopping, error)																										
50	Counter clockwise (not at noP, LS, abnormal stopping, error)																										
51	Warning E.OL2																										
52	Current control at the limit (only F5-M/S)																										
53	Speed control at the limit																										
54	Target window reached (Posi module at F5-M/S)																										
55	Current position > Level (Posi module at F5-M/S)																										
56	Positioning active (Posi module at F5-M/S)																										
57	Position inaccessible (Posi module at F5-M/S)																										
58	Profile processing active (Posi module at F5-M/S)																										
59	AND-operation of the selected inputs. The condition is active, if all selected inputs are active. The selection is done with the switching levels (LE.0...7) according to following table: <table border="1" data-bbox="146 1261 1166 1323"> <thead> <tr><th>Input</th><th>ST</th><th>RST</th><th>F</th><th>R</th><th>I1</th><th>I2</th><th>I3</th><th>I4</th><th>IA</th><th>IB</th><th>IC</th><th>ID</th></tr> </thead> <tbody> <tr><td>Value</td><td>1</td><td>2</td><td>4</td><td>8</td><td>16</td><td>32</td><td>64</td><td>128</td><td>256</td><td>512</td><td>1024</td><td>2048</td></tr> </tbody> </table> The sum of the inputs to be queried is entered in the switching levels. Example: If the inputs I3 and I4 are active, the condition do.4 shall be set. Adjust switching condition 4 (do.4) to „59“. Adjust switching level 4 (LE.4) to „192“ („64“ for I3 + „128“ for I4).	Input	ST	RST	F	R	I1	I2	I3	I4	IA	IB	IC	ID	Value	1	2	4	8	16	32	64	128	256	512	1024	2048
Input	ST	RST	F	R	I1	I2	I3	I4	IA	IB	IC	ID															
Value	1	2	4	8	16	32	64	128	256	512	1024	2048															
60	OR-operation of the selected inputs. The condition is active, if at least one of the selected inputs is active. Adjustment as at value „59“.																										
61	NAND-operation of the selected inputs. The condition is active, if at least one of the selected inputs is inactive. Adjustment as at value „59“.																										
62	NOR-operation of the selected inputs. The condition is active, if all of the selected inputs are inactive. Adjustment as at value „59“.																										
63	Absolute value ANOUT1 > Level																										
64	Absolute value ANOUT2 > Level																										
65	ANOUT1 > Level																										
66	ANOUT2 > Level																										
67	Active relative position > Level. The output is set, if the distance covered after the starting position is larger than the adjusted level. That means, the function works relative to the starting position. If the positioning is completed, the output is reset (Posi module at F5-M/S).																										
68	Active position to the target > Level. The output is set, if the distance to be covered to the target is larger than the adjusted level. If the positioning is completed, the output is reset (Posi module at F5-M/S).																										
Chapter	Section	Page	Date	Name: Basis	©	KEB Antriebstechnik, 2002 All rights reserved																					
6	3	14	16.04.02	KEB COMBIVERT F5																							

Level 0...7 These parameters defines the level of the switching conditions. Level 0 (LE.0) applies
LE.0...LE.7 for switching condition 0; LE.1 for switching condition 1 ... and so forth.

Setting range:	-30000,00...30000,00
Step:	0,01
Default:	see parameter table

Bei der Vorgabe in Inkrementen entspricht ein Inkrement gleich 0,01.

Hysteresis 0...7 The hysteresis, in reference to the adjusted values, defines the parameters
LE. 8...LE.15 LE. 8...LE.15. Hysteresis 0 (LE.8) applies for comparison level 0; LE.9 for comparison level 1 ... and so forth.

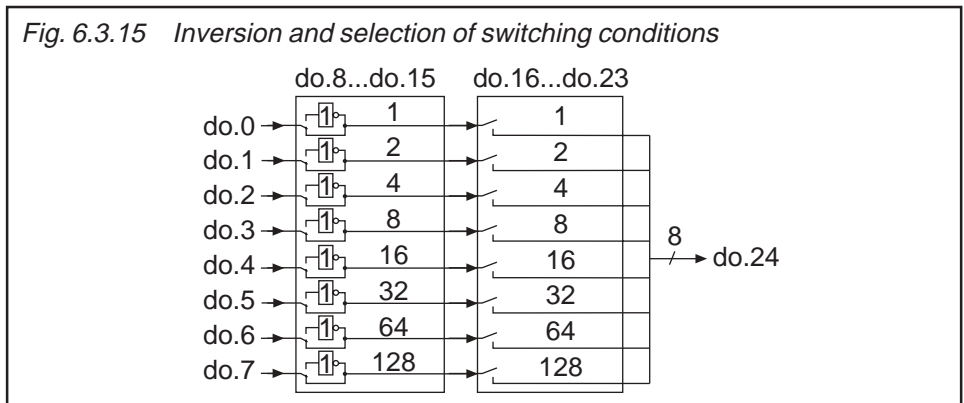
Default:	
Frequency:	0,5 Hz
Voltage:	1 V
Analog values:	0,5 %
Current:	0,5 A
Temperature:	1 °C

Frequency hysteresis LE.16 LE.16 defines the hysteresis for the status constant-run and tripping frequencies for the DC-brake.

Response to warning signals These parameters determine the behaviour of the inverter in case of warning signals.
Pn.8, Pn.10, Pn.12, Pn.14, To learn more about the adjustment possibilities as well as the performance of the
Pn.16 appropriate drive please refer to Chapter 6.7 „Protective functions“.

6.3.16 Inverting of Switching Conditions for Flags (do.8...do.15)

Fig. 6.3.15 Inversion and selection of switching conditions



With the parameters do.8...do.15 each of the 8 switching conditions (do.0...do.7) can be inverted for each flag separately. Through this function it is possible to set any chosen switching condition as Non-condition. The parameter is bit-coded. According to Fig. 6.3.15 the weighting of the switching conditions to be inverted must be entered in do.8...do.15. If several conditions shall be inverted, the sum is to be formed.

Example: Output X2A.19 shall be set when the inverter is not accelerating. In this case we assign the switching condition 21 (inverter accelerates) for example to do.1 (enter value 21). We invert the switching condition with do.9, so enter value 2.

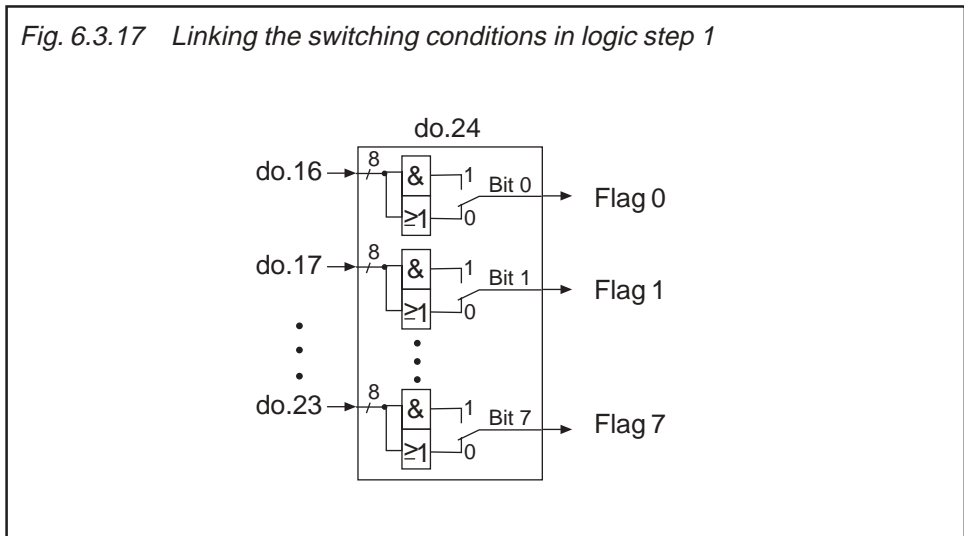
6.3.17 Selection of Switching Conditions for Flags (do.16...do.23)

The parameters do.16...do.23 serve for the selection of the 8 defined switching conditions. The selection is done for each channel separately, where one can choose between no one and up to all 8 switching conditions. According to Fig. 6.3.15 the weighting of the selected switching conditions is to be entered into do.16...do.23. If several conditions are selected, the sum is to be formed.

6.3.18 Linking the Switching Conditions for Flags (do.24)

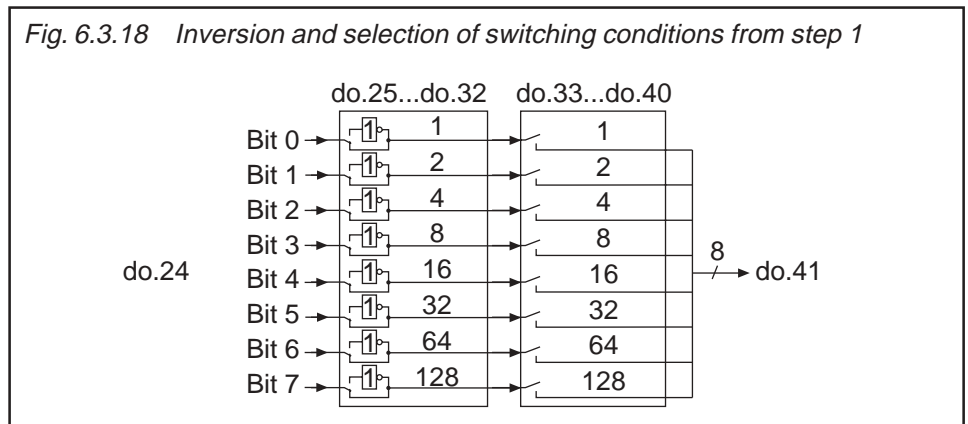
After the switching conditions are selected for each output, it can now be determined, how these are linked. As a default all conditions are OR-operated, i.e. if one of the selected conditions is met, the output switches. Another possibility is the AND-operation which can be adjusted with do.24. AND-operation means that all selected conditions must be fulfilled before the output switches. Parameter do.24 is bit-coded. The table under 6.3.17 shows the assignment.

Fig. 6.3.17 Linking the switching conditions in logic step 1



6.3.19 Inverting of Flags (do.25...do.32)

Fig. 6.3.18 Inversion and selection of switching conditions from step 1



With the parameters do.25...do.32 each of the 8 flags (bit 0...7) from logic step 1 can be inverted separately. Through this function it is possible to set any chosen flag as Non-flag. The parameter is bit-coded. According to Fig. 6.3.18 the weighting of the switching conditions to be inverted must be entered in do.25...do.32. If several flags shall be inverted, the sum is to be formed.

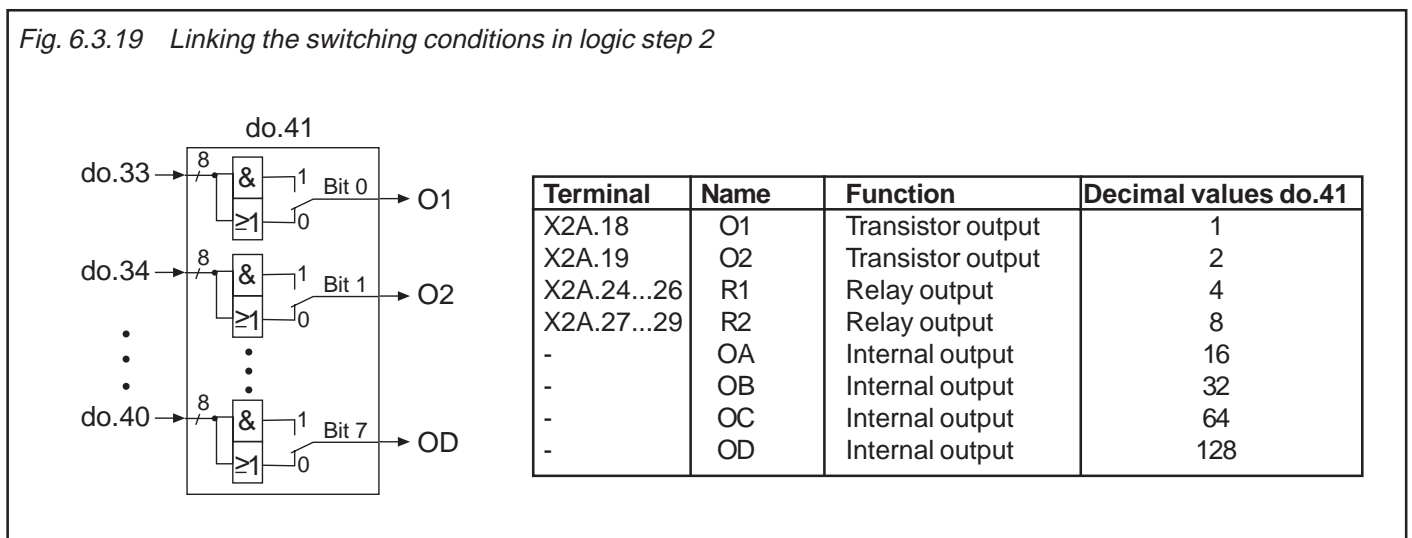
6.3.20 Selection of Flags (do.33...do.40)

In the second logic step a selection of the flags of the first logic step can be made. The selection is done for each output separately, where one can choose between no one and up to all 8 flags. According to Fig. 6.3.18 the weighting of the selected flags is to be entered into do.33...do.40. If several flags shall be selected, the sum is to be formed.

6.3.21 Linking the Flags (do.41)

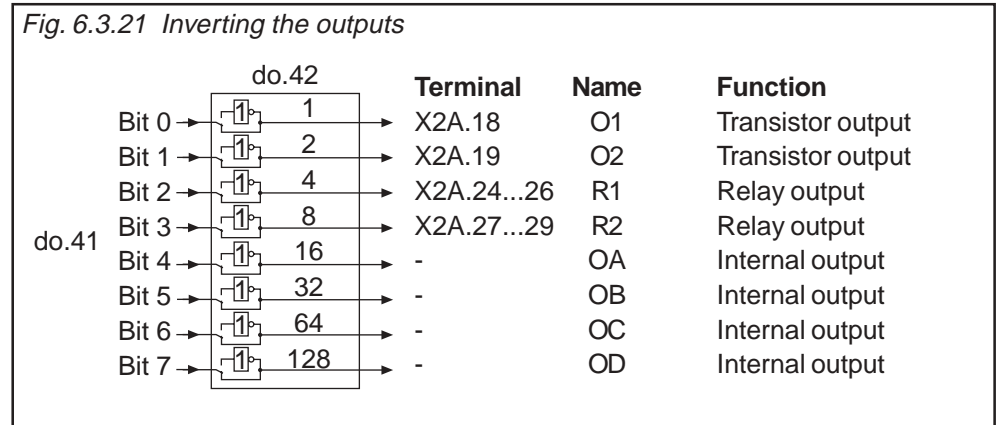
After the switching conditions are selected for each output, it can now be determined, how these are linked. As a default all conditions are OR-operated, i.e. if one of the selected conditions is met, the output switches. Another possibility is the AND-operation, which is adjusted with do.41. AND-operation means, that all selected conditions must be fulfilled before the output switches. Parameter do.41 is bit-coded. The table under 6.3.20 shows the assignment.

Fig. 6.3.19 Linking the switching conditions in logic step 2



6.3.22 Inversion of Outputs (do.42)

As shown in Fig. 6.3.21, with parameter do.42 the outputs can be once again inverted after the linking. The parameter is bit-coded, i.e. according to following table the value belonging to this output must be entered. If several outputs shall be inverted the sum is to be formed



6.3.23 Output Terminal Status (ru.25)

The output terminal status shows the logical status of the digital outputs. It is unimportant whether the output is set on the basis of conditions or by inversion. If an output is set, the appropriate decimal value, according to the table below, is output. If several outputs are set, then the sum of the decimal values is output.

Terminal	Name	Function	Decimal values ru.25
X2A.18	O1	Transistor output	1
X2A.19	O2	Transistor output	2
X2A.24...26	R1	Relay output	4
X2A.27...29	R2	Relay output	8
-	OA	Internal output	16
-	OB	Internal output	32
-	OC	Internal output	64
-	OD	Internal output	128

6.3.24 Programming Example

For a better understanding, the correlations shall be explained by means of a little more complex example. Following conditions are required:

- Condition 1: Output X2A.19 switches, if the inverter accelerates
- Condition 2: Relais X2A.24...26 switches, if the inverter load is > 100 %
- Condition 3: Relais X2A.27...29 switches, if the actual frequency is > 4 Hz
- Output X2A.18 switches, if the conditions 2 and 3 are realized, but the inverter **does not** accelerate.

Solution proposal:

Set switching conditions, levels and hysteresis

First set the switching conditions and levels.

Set do.0 to „21“ (inverter accelerates)

Set do.1 to „24“ (inverter utilization > level); set LE.1 to „100“ (load level for do.1 100 %); set LE.9 to „5“ (5 % hysteresis for level 1; not required but reasonable for optimal switching performance)

Set do.2 to „27“ (actual frequency > level); set LE.2 to „4“ (frequency level for do.2=4 Hz); set LE.10 to „0.5“ (0.5 Hz hysteresis for level 3; not required but reasonable for optimal switching performance)

Set switching conditions of stage 1

Set do.16 to „1“ (evaluate switching condition of do.0)

Set do.17 to „2“ (evaluate switching condition of do.1)

Set do.18 to „4“ (evaluate switching condition of do.2)

Set do.8, do.9 and do.10 to „0“ (no inverting)

The setting of do.24 is independent for this example, as only one condition each is set at do.16...18.

Set flags

Output O1 (terminal X2A.18)

Set do.33 to „7“ (evaluate flags 1...3)

Set do.25 to „1“ (flag 1 is inverted, it means that the condition is fulfilled if the inverter does not accelerate.

Set do.41 to „1“ (the conditions selected with do.33 become AND-operated)

Output O2 (terminal X2A.19)

Set do.34 to „1“ (evaluate flag 1)

Set do.26 to „0“ (no inverting)

The setting of do.41 is independent for this example, as only one condition is set at do.34.

Relais output R1 (terminal X2A.24...26)

Set do.35 to „2“ (evaluate flag 2)

Set do.27 to „0“ (no inverting)

The setting of do.41 is independent for this example, as only one condition is set at do.35.




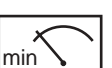




Relais output R2 (terminal X2A.27...29)

Set do.36 to „4“ (evaluate flag 3)




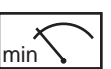




Set do.28 to „0“ (no inverting)




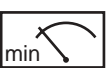
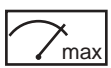



The setting of do.41 is independent for this example, as only one condition is set at do.36.

6.3.25 Used Parameters

Param.	Adr.								
di.0	0B00h	✓	-	✓	0	1	1	0	0: PNP 1:NPN
di.1	0B01h	✓	-	✓	0	4095	1	0	-
di.2	0B02h	✓	-	✓	0	4095	1	0	-
di.3	0B03h	✓	-	✓	0	127	1	0	-
di.4	0B04h	✓	-	✓	0	4095	1	0	-
di.5	0B05h	✓	-	✓	0	4095	1	0	-
di.6	0B06h	✓	-	✓	0	4095	1	0	-
di.7	0B07h	✓	-	✓	0	2	1	0	-
di.8	0B08h	✓	-	✓	0	4095	1	0	-
di.9	0B09h	✓	-	✓	0	4095	1	3	-
di.10	0B0Ah	✓	-	✓	0	4095	1	3	-
di.11	0B0Bh	✓	-	✓	0	2 ³¹ - 1	1	1	-
di.12	0B0Ch	✓	-	✓	0	2 ³¹ - 1	1	2	-
di.13	0B0Dh	✓	-	✓	0	2 ³¹ - 1	1	8192	-
di.14	0B0Eh	✓	-	✓	0	2 ³¹ - 1	1	512	-
di.15	0B0Fh	✓	-	✓	0	2 ³¹ - 1	1	0	-
di.16	0B10h	✓	-	✓	0	2 ³¹ - 1	1	0	-
di.17	0B11h	✓	-	✓	0	2 ³¹ - 1	1	0	-
di.18	0B12h	✓	-	✓	0	2 ³¹ - 1	1	0	-
di.19	0B13h	✓	-	✓	0	2 ³¹ - 1	1	32	-
di.20	0B14h	✓	-	✓	0	2 ³¹ - 1	1	64	-
di.21	0B15h	✓	-	✓	0	2 ³¹ - 1	1	128	-
di.22	0B16h	✓	-	✓	0	2 ³¹ - 1	1	128	-
do.0	0C00h	✓	✓	✓	0	68	1	20	-
do.1	0C01h	✓	✓	✓	0	68	1	3	-
do.2	0C02h	✓	✓	✓	0	68	1	4	-
do.3	0C03h	✓	✓	✓	0	68	1	27	-
do.4	0C04h	✓	✓	✓	0	68	1	0	-
do.5	0C05h	✓	✓	✓	0	68	1	0	-
do.6	0C06h	✓	✓	✓	0	68	1	0	-
do.7	0C07h	✓	✓	✓	0	68	1	0	-
do.8	0C08h	✓	✓	✓	0	255	1	0	-
do.9	0C09h	✓	✓	✓	0	255	1	0	-
do.10	0C0Ah	✓	✓	✓	0	255	1	0	-

Param.	Adr.	RW	PROG.	ENTER	min	max	Step	default	
do.11	0C0Bh	✓	✓	✓	0	255	1	0	-
do.12	0C0Ch	✓	✓	✓	0	255	1	0	-
do.13	0C0Dh	✓	✓	✓	0	255	1	0	-
do.14	0C0Eh	✓	✓	✓	0	255	1	0	-
do.15	0C0Fh	✓	✓	✓	0	255	1	0	-
do.16	0C10h	✓	✓	✓	0	255	1	1	-
do.17	0C11h	✓	✓	✓	0	255	1	2	-
do.18	0C12h	✓	✓	✓	0	255	1	4	-
do.19	0C13h	✓	✓	✓	0	255	1	8	-
do.20	0C14h	✓	✓	✓	0	255	1	16	-
do.21	0C15h	✓	✓	✓	0	255	1	32	-
do.22	0C16h	✓	✓	✓	0	255	1	64	-
do.23	0C17h	✓	✓	✓	0	255	1	128	-
do.24	0C18h	✓	✓	✓	0	255	1	0	-
do.25	0C19h	✓	✓	✓	0	255	1	0	-
do.26	0C1Ah	✓	✓	✓	0	255	1	0	-
do.27	0C1Bh	✓	✓	✓	0	255	1	0	-
do.28	0C1Ch	✓	✓	✓	0	255	1	0	-
do.29	0C1Dh	✓	✓	✓	0	255	1	0	-
do.30	0C1Eh	✓	✓	✓	0	255	1	0	-
do.31	0C1Fh	✓	✓	✓	0	255	1	0	-
do.32	0C20h	✓	✓	✓	0	255	1	0	-
do.33	0C21h	✓	✓	✓	0	255	1	1	-
do.34	0C22h	✓	✓	✓	0	255	1	2	-
do.35	0C23h	✓	✓	✓	0	255	1	4	-
do.36	0C24h	✓	✓	✓	0	255	1	8	-
do.37	0C25h	✓	✓	✓	0	255	1	16	-
do.38	0C26h	✓	✓	✓	0	255	1	32	-
do.39	0C27h	✓	✓	✓	0	255	1	64	-
do.40	0C28h	✓	✓	✓	0	255	1	128	-
do.41	0C29h	✓	✓	✓	0	255	1	0	-
do.42	0C2Ah	✓	✓	✓	0	255	1	0	-
do.43	0C2Bh	✓	✓	✓	0 ms	1000 ms	1 ms	0 ms	-
do.44	0C2Ch	✓	✓	✓	0 ms	1000 ms	1 ms	0 ms	-

Param.	Adr.								
LE. 0	0D00h	✓	✓	-	-30000,00	30000,00	00,1	0,00	-
LE. 1	0D01h	✓	✓	-	-30000,00	30000,00	00,1	0,00	-
LE. 2	0D02h	✓	✓	-	-30000,00	30000,00	00,1	100,00	-
LE. 3	0D03h	✓	✓	-	-30000,00	30000,00	00,1	4,00	-
LE. 4	0D04h	✓	✓	-	-30000,00	30000,00	00,1	0,00	-
LE. 5	0D05h	✓	✓	-	-30000,00	30000,00	00,1	0,00	-
LE. 6	0D06h	✓	✓	-	-30000,00	30000,00	00,1	0,00	-
LE. 7	0D07h	✓	✓	-	-30000,00	30000,00	00,1	0,00	-
LE. 8	0D08h	✓	✓	-	0,00	300,00	0,01	0,00	-
LE. 9	0D09h	✓	✓	-	0,00	300,00	0,01	0,00	-
LE.10	0D0Ah	✓	✓	-	0,00	300,00	0,01	5,00	-
LE.11	0D0Bh	✓	✓	-	0,00	300,00	0,01	0,50	-
LE.12	0D0Ch	✓	✓	-	0,00	300,00	0,01	0,00	-
LE.13	0D0Dh	✓	✓	-	0,00	300,00	0,01	0,00	-
LE.14	0D0Eh	✓	✓	-	0,00	300,00	0,01	0,00	-
LE.15	0D0Fh	✓	✓	-	0,00	300,00	0,01	0,00	-
LE.16	0D10h	✓	-	-	0 Hz	20 Hz	0,0125 Hz	0,8 Hz	dependend on ud.2
LE.17	0D11h	✓	-	✓	0	4095	1	0	-
LE.19	0D13h	✓	-	✓	0	4095	1	0	-
LE.22	0D16h	✓	-	✓	0	4095	1	0	-
LE.24	0D18h	✓	-	✓	0	4095	1	0	-
ru.21	0215h	-	-	-	0	4095	1	-	-
ru.22	0216h	-	-	-	0	4095	1	-	-
ru.23	0217h	-	-	-	0	255	1	-	-
ru.24	0218h	-	-	-	0	255	1	-	-
ru.25	0219h	-	-	-	0	255	1	-	-
oP.19	0313h	✓	-	✓	0	4095	1	16	l1
oP.20	0314h	✓	-	✓	0	4095	1	32	l2
oP.56	0337h	✓	-	✓	0	4095	1	0	-
oP.57	0338h	✓	-	✓	0	4095	1	0	-
oP.58	0339h	✓	-	✓	0	4095	1	0	-
oP.60	033Bh	✓	-	✓	0	4095	1	4	F
oP.61	033Ch	✓	-	✓	0	4095	1	8	R
Pn. 4	0404h	✓	-	✓	0	4095	1	64	l3
Pn.23	0417h	✓	-	✓	0	4095	1	0	-

Param.	Adr.								
Pn.29	041Dh	✓	-	✓	0	4095	1	128	default 0 at F5-M/S
Pn.64	0440h	✓	-	✓	0	4095	1	0	-
uF.8	0508h	✓	-	✓	0	4095	1	0	-
Fr.7	0907h	✓	-	✓	0	4095	1	0	-
Fr.11	090Bh	✓	-	✓	0	4095	1	0	-
An.3	0A03h	✓	-	✓	0	4095	1	0	-
An.13	0A0Dh	✓	-	✓	0	4095	1	0	-
An.23	0A17h	✓	-	✓	0	4095	1	0	-
LE.17	0D11h	✓	-	✓	0	4095	1	0	-
LE.19	0D13h	✓	-	✓	0	4095	1	0	-
LE.22	0D16h	✓	-	✓	0	4095	1	0	-
LE.24	0D18h	✓	-	✓	0	4095	1	0	-
cn.11	070Bh	✓	-	✓	0	4095	1	0	-
cn.12	070Ch	✓	-	✓	0	4095	1	0	-
cn.13	070Dh	✓	-	✓	0	4095	1	0	-
di.9	0B09h	✓	-	✓	0	4095	1	3	ST+RST
di.10	0B0Ah	✓	-	✓	0	4095	1	3	ST+RST

Chapter 6	Section 3	Page 24	Date 16.04.02	Name: Basis KEB COMBIVERT F5	© KEB Antriebstechnik, 2002 All rights reserved
---------------------	---------------------	-------------------	------------------	--	--

1. Introduction

2. Summary

3. Hardware

4. Operation

5. Parameter

6. Functions

7. Start-up

8. Special Operation

9. Error Assistance

10. Project Planning

11. Networks

12. Annex

6.1 Operating and Appli-
cance Date

6.2 Analog In- and Outputs

6.3 Digital In- and Outputs

**6.4 Set Value and Ramp
Adjustment**

6.5 Voltage-/Frequency
Characteristic (*U/f*)
Adjustment

6.6 Motor Data Adjustment

6.7 Protective Functions

6.8 Parameter Sets

6.9 Special Functions

6.10 Encoder Interface

6.11 SMM

6.12 Technology Control

6.13 CP-Parameter Definition

6.4.1	Summary Description	3
6.4.2	Setpoint Selection	4
6.4.3	Rotation Selection	6
6.4.4	Fixed Frequencies	9
6.4.5	Setpoint Limits	11
6.4.6	Setpoint Computation	12
6.4.7	Ramp Generator	13
6.4.8	Limiter	15
6.4.9	Ramp with constant time	15
6.4.10	Used Parameters	18

6.4 Setpoint-, Rotation- and Ramp Adjustment

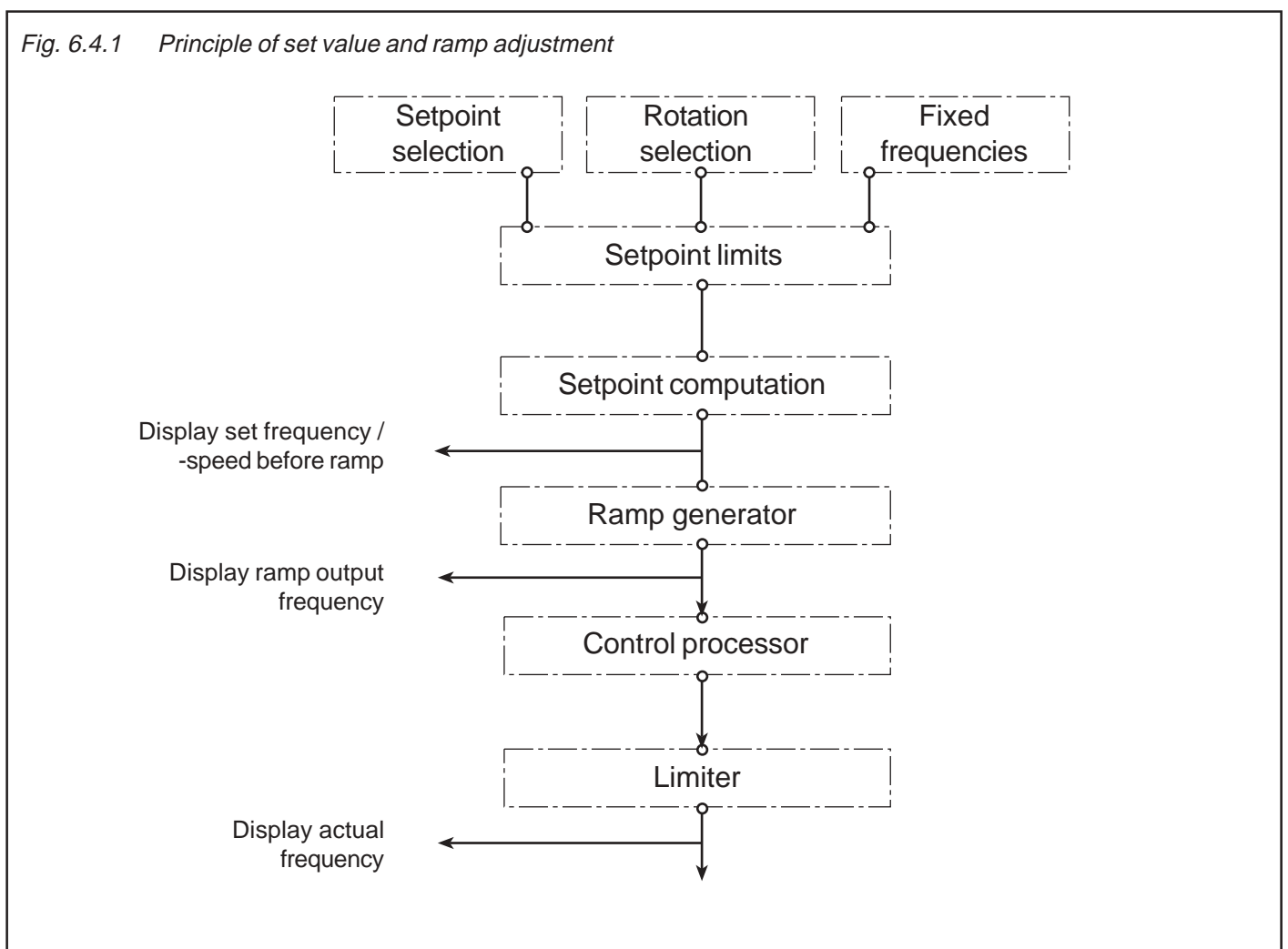
6.4.1 Summary Description

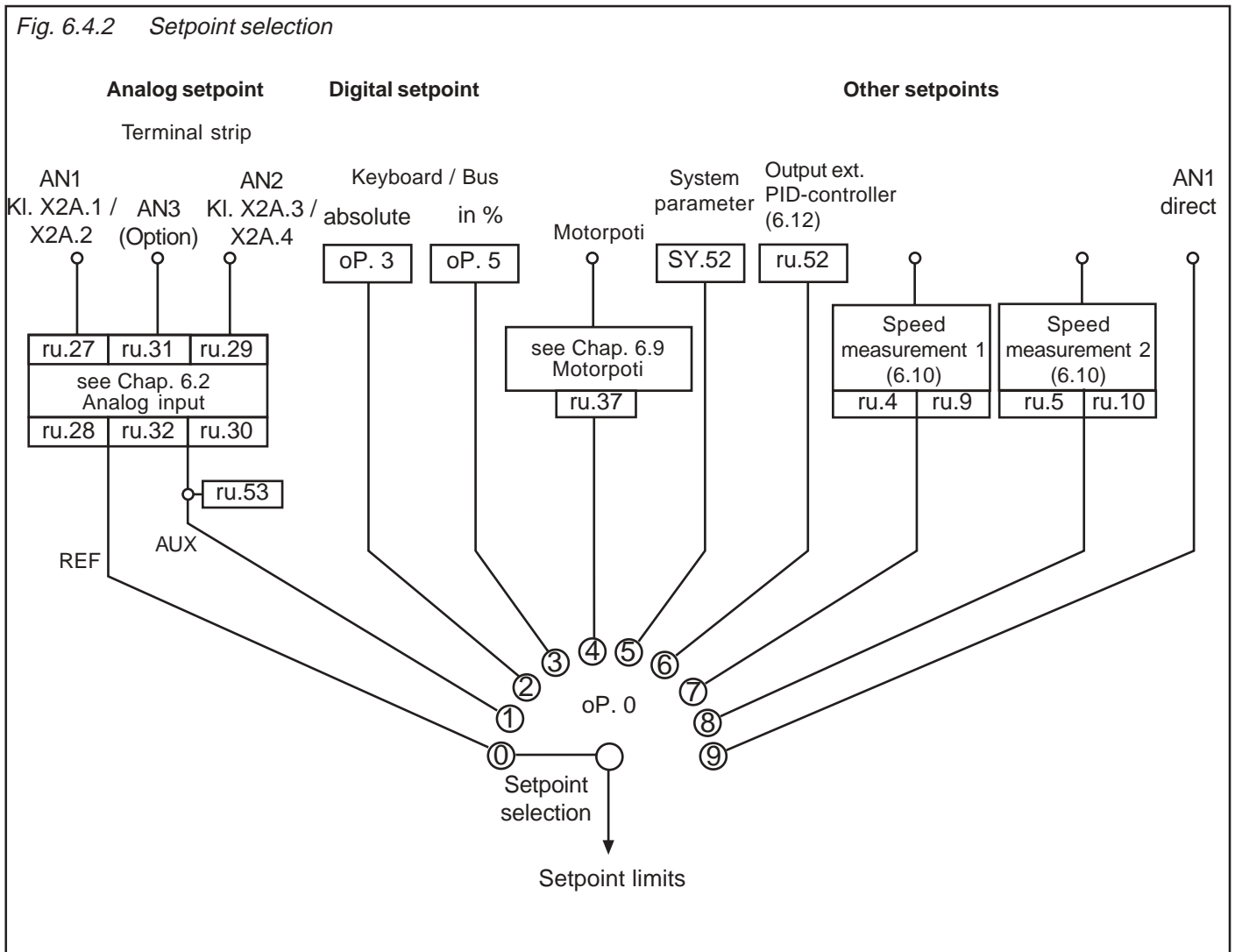
The setpoint values of the KEB COMBIVERT F5 can be preadjusted analog as well as digital. The AUX-function adds or multiplies an analog setpoint to/with other setpoint settings.

The setpoint and rotation selection links the different setpoint sources with the possible sources of rotation direction. The signal thus obtained is used for further setpoint calculation.

Only after interrogation of the absolute setpoint limits, all the data that is required for the ramp calculation is available.

Fig. 6.4.1 Principle of set value and ramp adjustment





6.4.2 Setpoint Selection oP.0

With oP.0 it is determined how the setpoint is adjusted.

Analog setpoint The analog setpoints are adjusted via AN1, AN2 or AN3 (option). Chapter 6.2 „Analog In- and Outputs“ describes the analog signal processing. The indication of the setpoints can occur either before or after the signal processing (ru.27...32, ru.53).

Digital setpoint With parameter oP.3 „Absolute digital setpoint adjustment“ a setpoint frequency of -400... 400 Hz can be adjusted. With parameter oP.5 „Digital setpoint adjustment in percent“ a setpoint of -100% ... +100% of the maximal frequency (oP.10 / oP.11) can be adjusted.

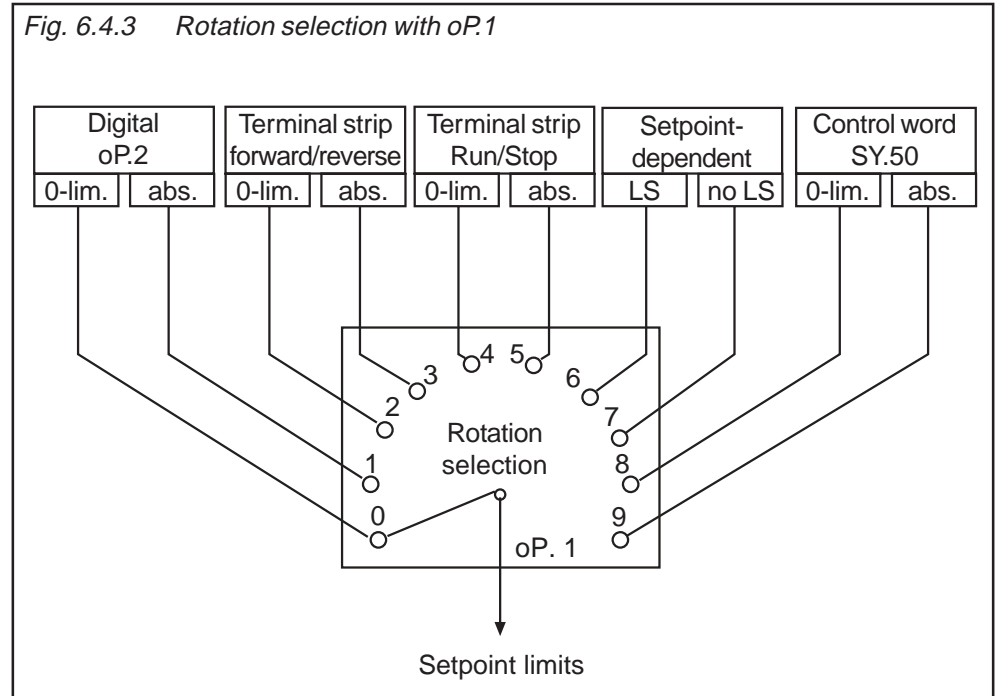
Motorpoti function With the motorpoti function a setpoint of -100%...0...100% between the limits adjusted in the parameters oP.6 / oP.7 and oP.10 / oP.11 can be adjusted via digital inputs (see 6.9.3 „Motorpoti function“).

System parameters Adjustment of absolute setpoint speed in rpm (SY.52) via the system parameters.

Output external PID-controller	Adjustment of the setpoint value from the output of the technology controller (see 6.12).
Speed measurement (not at B-control)	Adjustment of the setpoint value via one of the two speed measurements (see 6.10).
Direct analog setpoint adjustment (AN1 direct) (not at B-control)	<p>The cycle time of the software is 1 ms (BASIC: 2). During this time the analog input/output status is updated once. Additionally the inverter requires a processing time of 1...3 ms before the new setpoint value is calculated. If the inverter is used as secondary final control element of a superior control, this time can impair the dynamics of the entire closed-loop control system.</p> <p>In such cases the analog setpoint value can be processed directly to the control processor (direct setpoint adjustment). Thus a sampling time of 250 μs is possible. To enable this fast response to an analog setpoint value, some restrictions must be accepted:</p> <ul style="list-style-type: none"> • The setpoint limitations oP. 6 / oP. 7 / oP. 11 do not have any function; the frequency setpoint is only limited by oP. 14 (for both directions). • The calculation formula of the analog setpoint value changes. The parameters oP.6 / oP. 7 are without influence on the setpoint calculation. $n_{\text{set}} = (\text{analog value}/10\text{V} * 100\% - \text{An. 6}) * \text{An. 5} * \text{oP.10}$ <ul style="list-style-type: none"> • The acceleration / deceleration and S-curve time have no effect; it is operated internally without ramps. • The parameters An.1...4 and An. 7...9 are without any function. • The maximal filter time for the analog inputs is 2 ms.

6.4.3 Rotation Selection oP.1

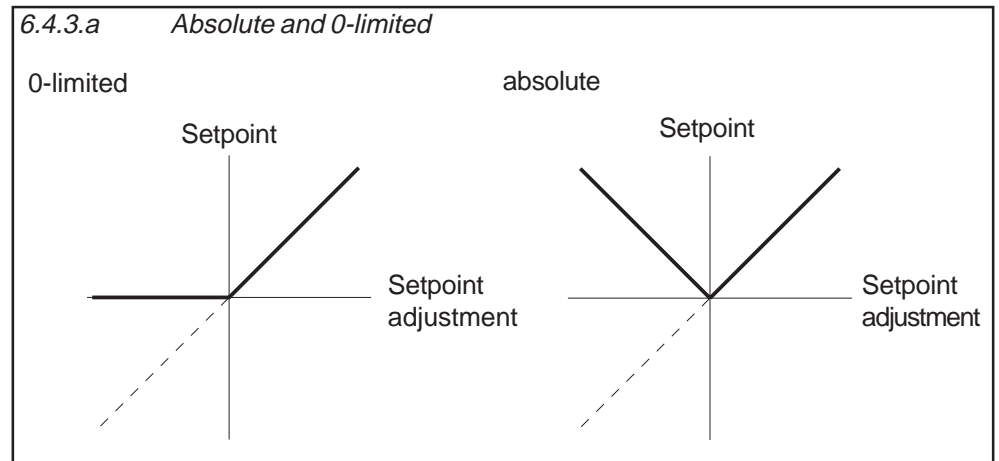
The selection of rotation direction determines the manner in which the rotation direction is adjusted. One can choose between following possibilities:



0-limited or absolute

Concerning the adjustment of direction of rotation it is differentiated between two evaluations:

- 0-limited - negative setpoints are set to zero, i.e. only positive setpoints are driven in accordance with the selected rotation direction
- absolute - no sign of the setpoint is evaluated and it is always driven with the amount in accordance with the selected rotation direction



Digital rotation adjustment (oP.2)

oP.2	Display	Setpoint rotation
0	LS	Standstill (Low Speed)
1	F	Forward (Forward)
2	r	Reverse (Reverse)

Rotation adjustment via terminal strip

The rotation selection via terminal strip allows the adjustment of the direction of rotation via switch or from a primary control.

Input selection
 Rotation direction F (Run/Stop) oP.60
 Rotation direction R (forward/reverse) oP.61

With parameter oP.60 one input is determined for rotation direction forward (or run/stop) and with oP.61 one input for rotation direction reverse (or forward/reverse).

Bit -No.	Decimal value	Input	Terminal
0	1	ST (Prog. input „Control release/Reset“)	X2A.16
1	2	RST (Prog. input „Reset“)	X2A.17
2	4	F (Prog. input „Forward“) ¹⁾	X2A.14
3	8	R (Prog. input „Reverse“) ²⁾	X2A.15
4	16	I1 (Prog. input 1)	X2A.10
5	32	I2 (Prog. input 2)	X2A.11
6	64	I3 (Prog. input 3)	X2A.12
7	128	I4 (Prog. input 4)	X2A.13
8	256	IA (Internal input A)	none
9	512	IB (Internal input B)	none
10	1024	IC (Internal input C)	none
11	2048	ID (Internal input D)	none

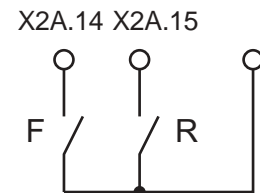
1) default at oP.60

2) default at oP.61

oP.1 = „2“ or „3“

In the case of rotation selection forward/reverse (oP.1= „2“ or „3“) the inputs determined with oP.60 and oP.61 work as follows:

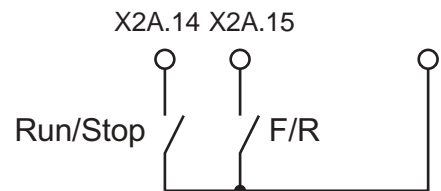
Forward	Revers	Input
F	R	Function
0	0	LS
0	1	Reverse
1	0	Forward
1	1	Forward



oP.1 = „4“ or „5“

In the case of rotation selection run/stop and forward/reverse (oP.1= „4“ or „5“) the inputs determined with oP.60 and oP.61 work as follows:

Revers	Forward	Input
F/R	Run/Stop	Function
0	0	LS
0	1	Forward
1	0	LS
1	1	Reverse



Rotation direction is dependent on the sign of the setpoint

The direction of rotation can be defined with the preadjusted setpoint signal. In the case of analog signals through adjustment of positive or negative voltages. In the case of digital signals through adjustment of positive frequencies (without sign) or negative frequencies (negative sign in the display). Following settings are possible:

Evaluation with LS
(switch-off of modulation)

In this case a direction of rotation must be adjusted via a digital input, digitally via oP.2 or via control word SY.50 in order for the inverter to modulate. It is unimportant which direction of rotation is adjusted, as the direction of rotation is dependent on the setpoint.

- no rotation direction set -> LS (Modulation disabled)
- oP.1 = 6 set direction of rot.;pos. value (also 0) -> rotation direction forward
- set direction of rot.;negative value -> rotation direction revers

Evaluation without LS

In this case the inverter always modulates. No direction of rotation needs to be adjusted.

- oP.1 = 7 positive value (also 0) -> rotation direction forward
- negative value -> rotation direction reverse

Rotation direction is dependent on the control word SY.50

The control word is used for the state control of the inverter via bus. In order for the inverter to react to the control word, the respective control process must be enabled (oP.1=8 or 9). When adjusting the direction of rotation via the control word, the setpoint can be evaluated 0-limited (oP.1 = 8) or absolute (oP.1 = 9).

Control word (low) Sy.50

Bit	Function	Description
0	Control release	0 = control release not enabled; 1 = control release enabled This bit takes effect only if di.1 Bit 0 is set. Then the AND-operation with di.2 Bit 0 and the terminal ST is effective); control release ST (hardware) must be set additionally.
1	Reset	Triggers reset when changing from 0 => 1
2	Run / Stop	0 = setpoint rotation Stop; 1 = setpoint rotation Run (source of setpoint direction op.1 = 8 or 9)
3	For / Rev	0 = setpoint rotation forward; 1 = setpoint rotation reverse (source of setpoint rotation op.1 = 8 or 9)
4-6	Current set	Source of set selection fr.2 = 5
7	Free	
8	Fast stop	0 = fast stop not activated; 1 = fast stop activated (OR-operation with further sources for fast stop)
9-15	Free	

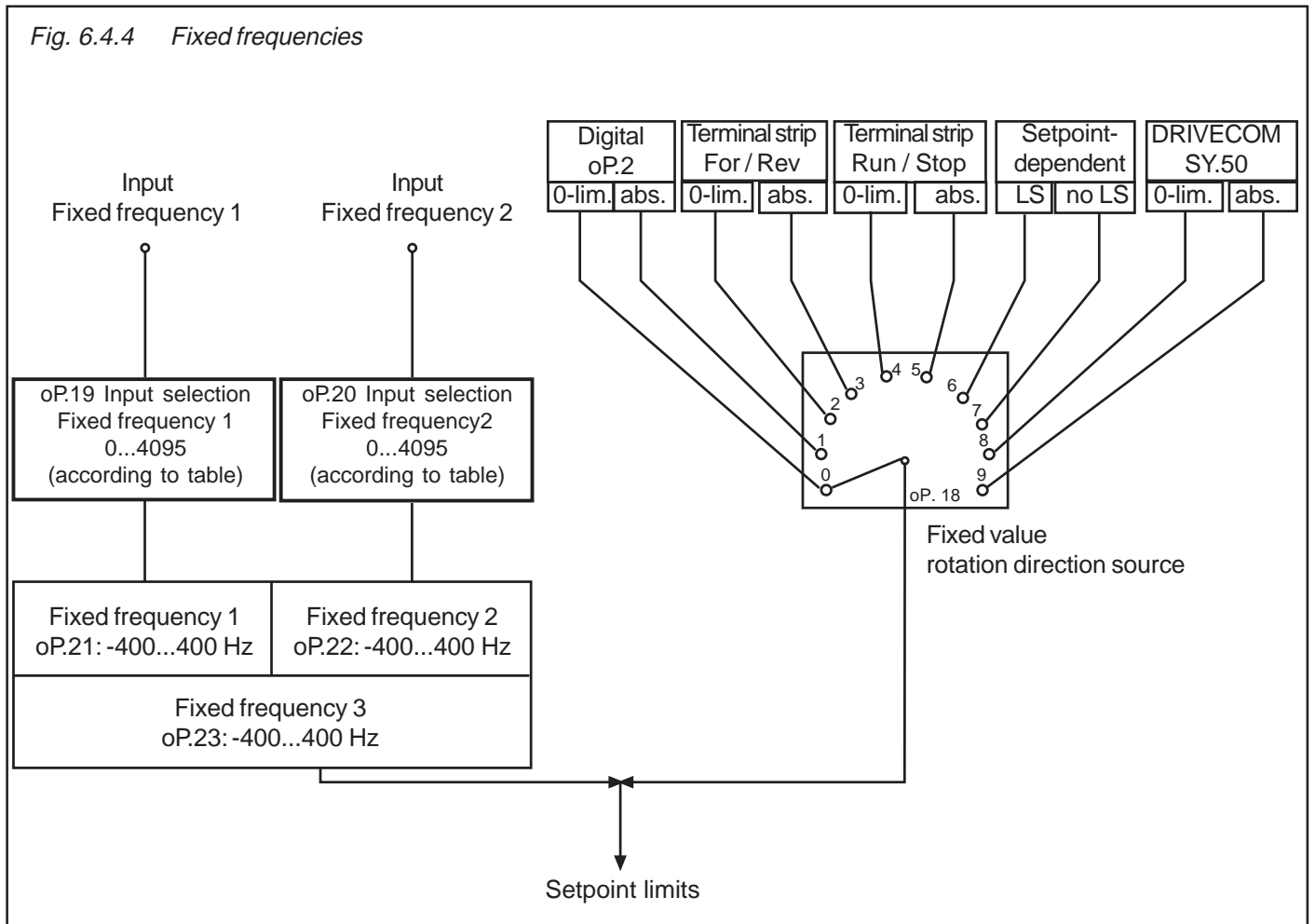


If Run/Stop is to be adjusted over the control word, oP.2 must be set to „0“. The terminals F/R may not be wired (OR-operation of terminal, oP.2 and Sy.50).

6.4.4 Fixed Frequencies (oP.18...23)

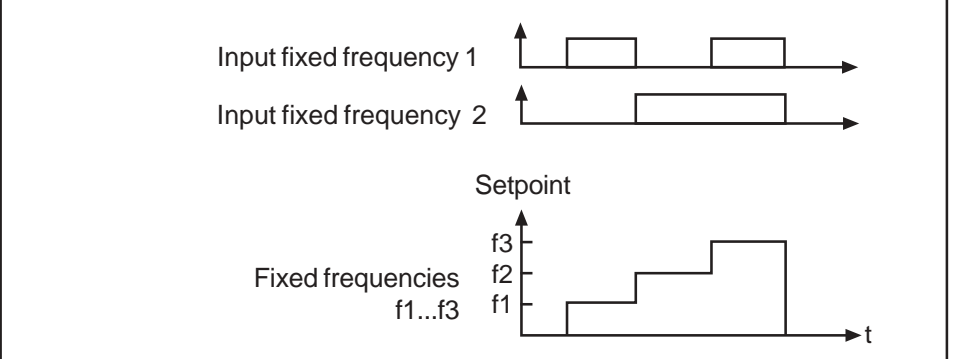
The KEB COMBIVERT supports up to 3 fixed frequencies for each parameter set, which can be selected via two digital inputs. With oP.19 and oP.20 the inputs required for the selection are defined (also see „Digital inputs“ Chapt. 6.3.11). The rotation direction source for fixed frequency mode is defined with oP.18. The adjustment is independent of oP.1 and is valid exclusively for the fixed frequencies. The adjustment of a fixed frequency has priority over the „normal“ setpoint adjustment.

Fig. 6.4.4 Fixed frequencies



Selection of fixed frequencies

Fig. 6.4.4.a Selection of fixed frequencies



Fixed-value rotation direction source (oP.18) With oP.18 it is defined how the direction of rotation is determined in case of active fixed frequency. The function and the value range correspond to oP.1.

oP.18	Rotation direction source for fixed frequencies
0	digital via oP.2; setpoint 0-limited
1	digital via oP.2; setpoint absolute
2	terminal strip F/R; setpoint 0-limited
3	terminal strip F/R; setpoint absolute
4	terminal strip Run/Stop; setpoint 0-limited
5	terminal strip Run/Stop; setpoint absolute
6	setpoint-dependent with LS-recognition
7	setpoint-dependent without LS-recognition
8	control word SY.50; 0-limited
9	control word SY.50; 0-absolute

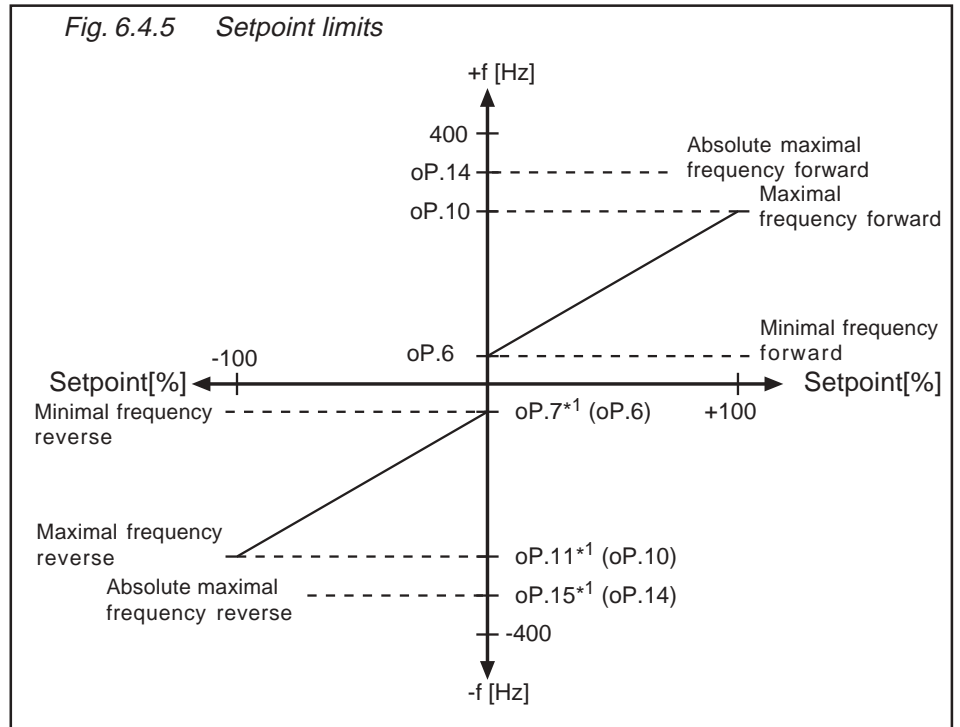
Fixed-value input selection 1 and 2 (oP.19; oP.20)

Bit -No.	Decimal value	Input	Terminal
0	1	ST (Prog. input „Control release/Reset“)	X2A.16
1	2	RST (Prog. input „Reset“)	X2A.17
2	4	F (Prog. input „Forward“)	X2A.14
3	8	R (Prog. input „Reverse“)	X2A.15
4	16	I1 (Prog. input 1)	X2A.10
5	32	I2 (Prog. input 2)	X2A.11
6	64	I3 (Prog. input 3)	X2A.12
7	128	I4 (Prog. input 4)	X2A.13
8	256	IA (Internal input A)	none
9	512	IB (Internal input B)	none
10	1024	IC (Internal input C)	none
11	2048	ID (Internal input D)	none

Fixed frequency 1...3 (oP.21, oP.22, oP.23) The three fixed frequencies oP.21...23 are set-programmable and can be adjusted in the range of -400...400 Hz.

6.4.5 Setpoint Limits

Following limit values can be preadjusted:



*1 If the value „=For“ is adjusted in these parameters (limit values rotation direction reverse), then the adjusted values for rotation direction forward (oP.6, oP.10 and oP.14) are valid.

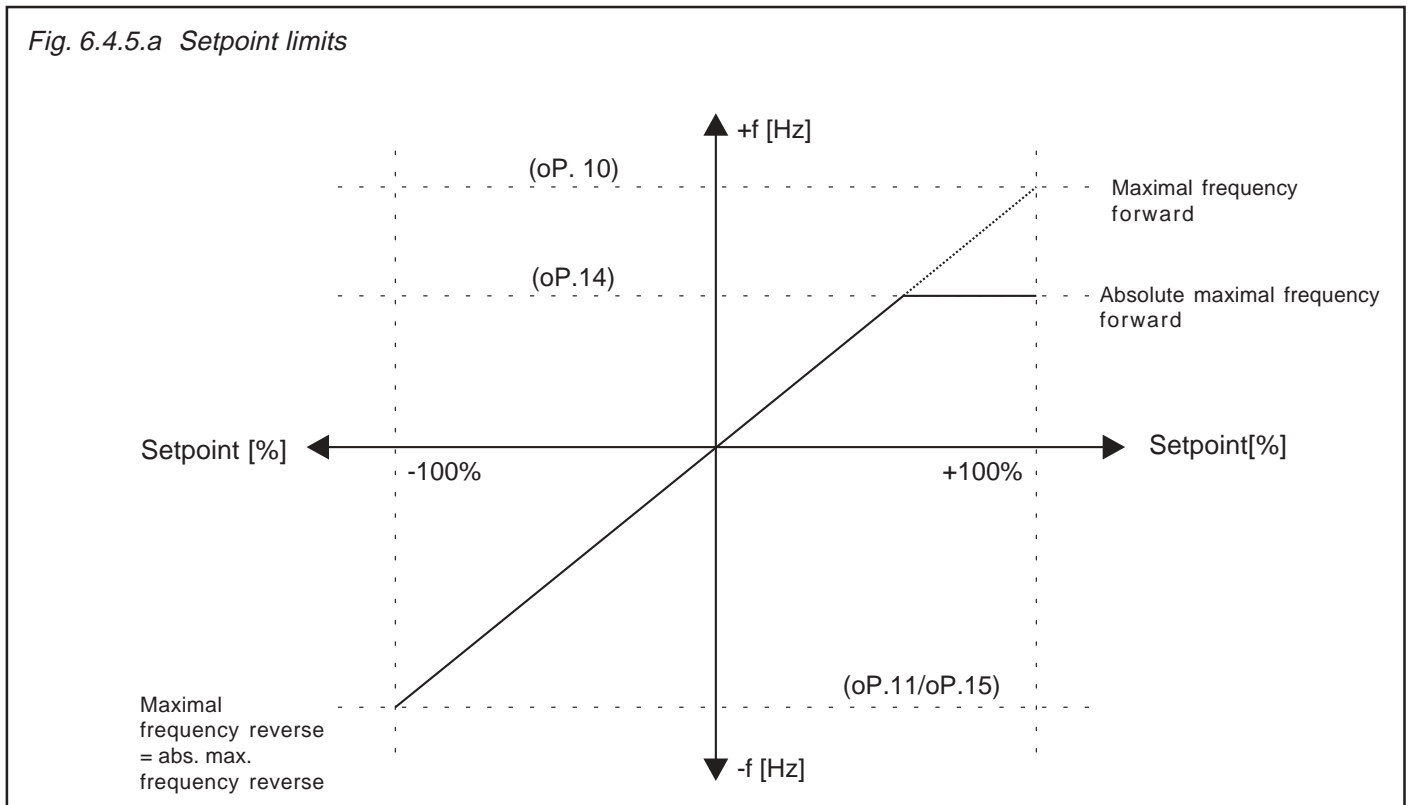
Minimal- / Maximal frequency (oP.6, oP.7, oP.10, oP.11)

In case of setpoint adjustment in percent the minimal and maximal frequencies form the characteristic for the frequency calculation (0% = minimal frequency; 100% = maximal frequency). In case of absolute setpoint adjustment the minimal and maximal frequencies limit the setpoint. Separate limits can be adjusted for both rotation directions. If the value „For“ is adjusted for rotation direction „Reverse“, then the values for „Forward“ are valid.

Setting range:	oP.6: 0...400 Hz	Default: 0 Hz
	oP.10: 0...400 Hz	Default: 70 Hz
	oP.7: =For, 0...400 Hz	Default: =For
	oP.11: =For, 0...400 Hz	Default: =For

Absolute maximal frequency (oP.14, oP.15)

After the minimal and maximal frequencies the setpoint is limited through the absolute maximal frequency and subsequently transferred to the ramp generator. Since the analog setpoint is always calculated onto the maximal frequencies (oP.10, oP.11), it is possible, to adjust the characteristic of the analog setpoint with the same gain for both rotation directions (see Fig. 6.4.5.a) in spite of different maximal output frequencies. If the value „=For“ is adjusted in oP.15, then the absolute maximal frequency of oP.14 is valid for both rotation directions.



6.4.6 Setpoint Computation

The unit differentiates between two setpoint adjustments:

- the setpoint adjustment
With the adjusted setpoint limits the frequency range 0%...100% is defined. In this case the adjustment 0% corresponds to the minimal frequency and 100% to the maximal frequency. The frequency is calculated according to the following formula:

$$\text{positive setpoint [Hz]} = \text{oP.6} + (\text{setpoint adjustment [\%]} \times \frac{\text{oP.10} - \text{oP.6}}{100\%})$$

$$\text{negative setpoint [Hz]} = \text{oP.7} + (\text{setpoint adjustment [\%]} \times \frac{\text{oP.11} - \text{oP.7}}{100\%})$$

The frequency is limited through the corresponding maximal frequencies.

- the absolute setpoint adjustment, i.e. the setpoint is directly adjusted as frequency and limited through the corresponding minimal and maximal frequencies as well as through the absolute maximal frequency.

The setpoint sources are assigned as follows:

Setpoint adjustment in percent

- Terminal strip (analog setpoint)
- Keyboard/Bus in %
- Motorpoti
- PID-controller

Absolute setpoint adjustment

- Keyboard/Bus absolute
- Set speed value SY.52
- Speed detection

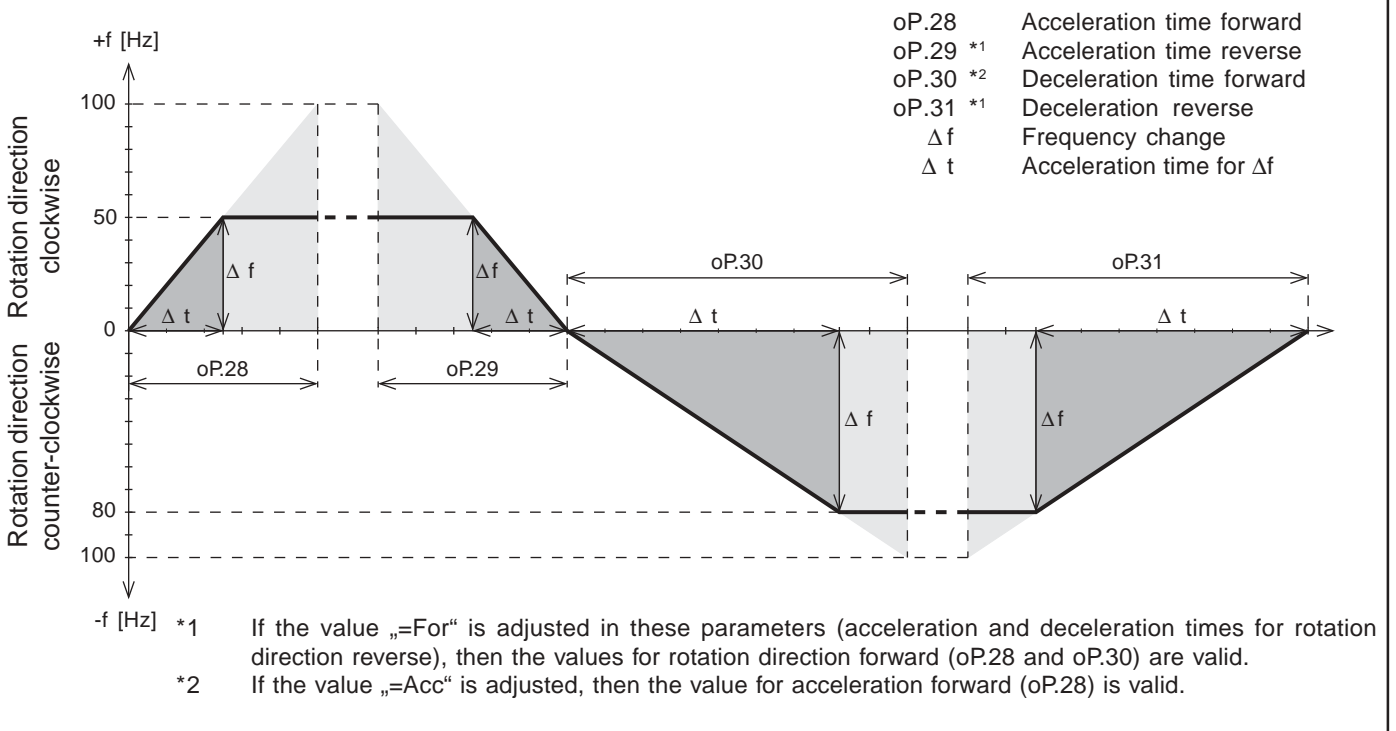
6.4.7 Ramp Generator

The ramp generator assigns an adjustable time to a frequency change, during this time the change stall take place. The acceleration time (for pos. frequency changes) and deceleration time (for neg. frequency changes) can be adjusted separately for both directions of rotation. To enable jerk-free acceleration and deceleration, so-called S-curves can be adjusted in addition to it.

The adjusted ramp times refer to 100Hz (at ud.2=0). The ramp times changes in proportion to the frequency change. The times to be adjusted are calculated as follows:

$$\frac{\text{desired ramp time}}{\text{ramp time to be adjusted (oP.28...oP.31)}} = \frac{\text{frequency change } (\Delta f)}{100 \text{ Hz (dep. on ud.2)}}$$

Fig. 6.4.7 Acceleration and deceleration times



ACC/DEC time factor (oP.62)

The time factor extends the standard ramp time (oP.28...31) by the adjusted value. The S-curve time do not change.

Value	Ramp time
0	adjusted value x 1
1	adjusted value x 2
2	adjusted value x 4
3	adjusted value x 8
4	adjusted value x 16

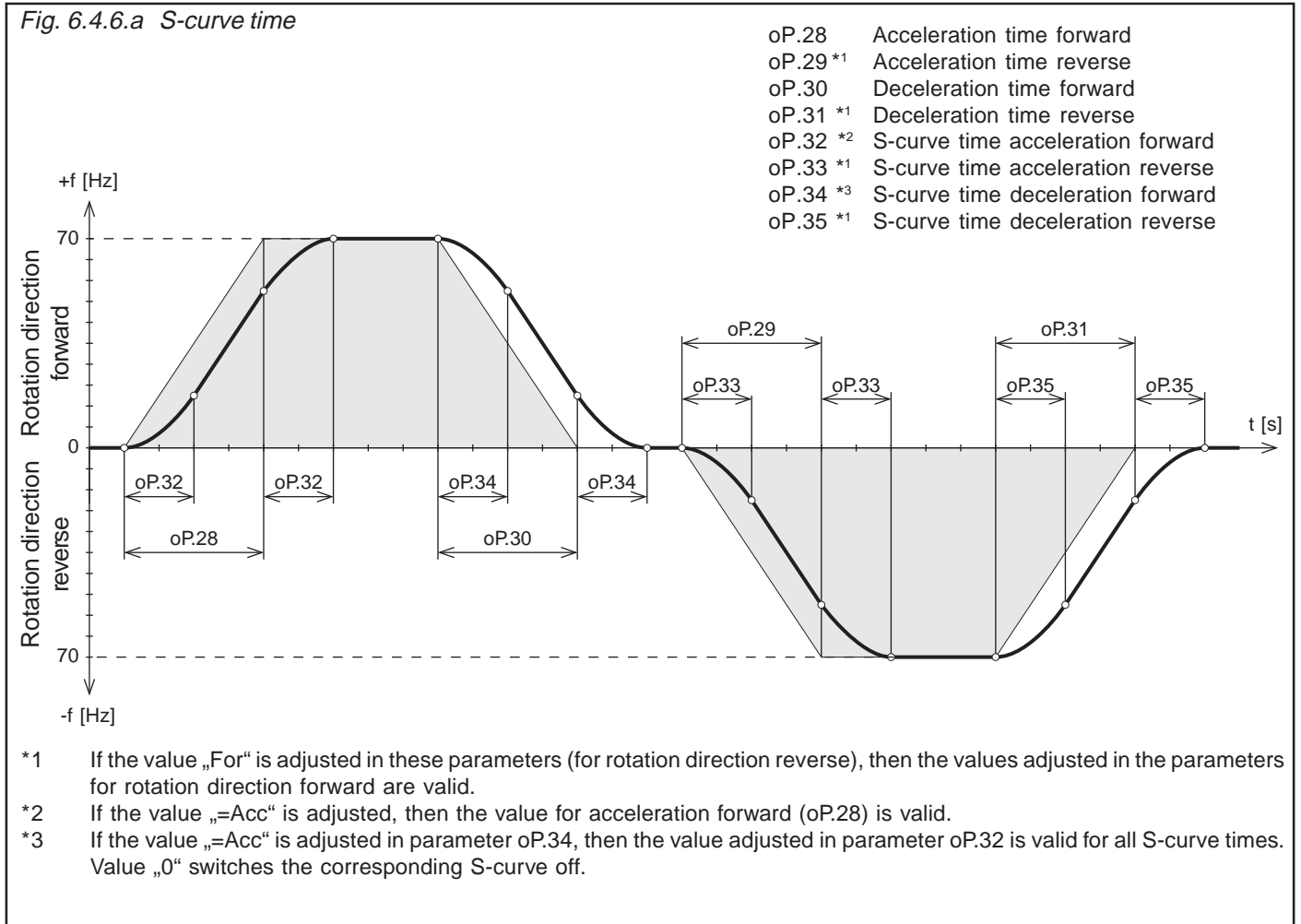
Calculation of the acceleration and deceleration times:

$$oP.28...oP.31 = \frac{100\text{Hz} \times \text{real ramp time}}{\Delta f}$$

Example A drive shall accelerate from 10Hz to 70Hz in 5s.

$$oP.28 = \frac{5\text{s} \times 100\text{Hz}}{(70\text{Hz}-10\text{Hz})} = 8,33\text{s}$$

S-curve time For some applications it is of advantage if the drive starts and stops nearly jerk-free. This function is achieved by straightening the acceleration and deceleration ramps. The straightening time, also called S-curve time, can be preadjusted with the parameters oP.32...oP.35. But S-curves are executed only with the adjustment „Ramp with constant rise“.



! In order to drive defined ramps with activated S-curve time, the preadjusted acceleration and deceleration times (oP.28...oP.31) must be larger than the S-curve time (oP.32...oP.34) belonging to it. !

Example for acceleration with rotation direction forward

At the beginning and the end of the acceleration ramp a parabolic curve is driven for the time adjusted in parameter oP.32. As a result the adjusted ramp time is extended by oP.32.

$$\text{Total acceleration time} = \text{oP.28} + \text{oP.32}$$

6.4.8 Limiter (oP.36...41)

The setpoint after the ramp generator can be changed for example through slip compensation. Before the setpoint triggers the modulator, it is once again limited. So the limiter determines the minimal and maximal output frequency and can be programmed differently in all sets.

Minimal output frequency clockwise rotation (oP.36) If the frequency drops below the adjusted minimal output frequency, the modulation is switched off. For oP.37 = „=For“, the value for clockwise-rotation oP.36 is valid.

Minimal output frequency counter-clockwise rotation (oP.37)

Setting range oP.36 0...400 Hz Default: 0 Hz
 Setting range oP.37 =For; 0...400 Hz Default: =For

Maximal output frequency clockwise rotation (oP.40)
 Maximal output frequency counter-clockwise rotation (oP.41)

If the frequency rises above the adjusted maximal output frequency, it is limited onto the adjusted value. For oP.41 = „=For“, the value for clockwise-rotation oP.40 is valid.

Setting range oP.40 0...400 Hz Default: 200 Hz
 Setting range oP.41 =For; 0...400 Hz Default: =For

6.4.9 Ramp with constant time

At the ramp with constant time the acceleration and deceleration times adjusted with oP.28...oP.31 always equal the real ramp times, independent of the set value. In this operating mode S-curves are not possible.

Here a little example for the use of ramps with constant time:

Two conveyor belts run with different speeds. Both of them receive the Stop-command at the same time. The belts reduce the speed in proportion to the adjusted time and come to a standstill simultaneously.

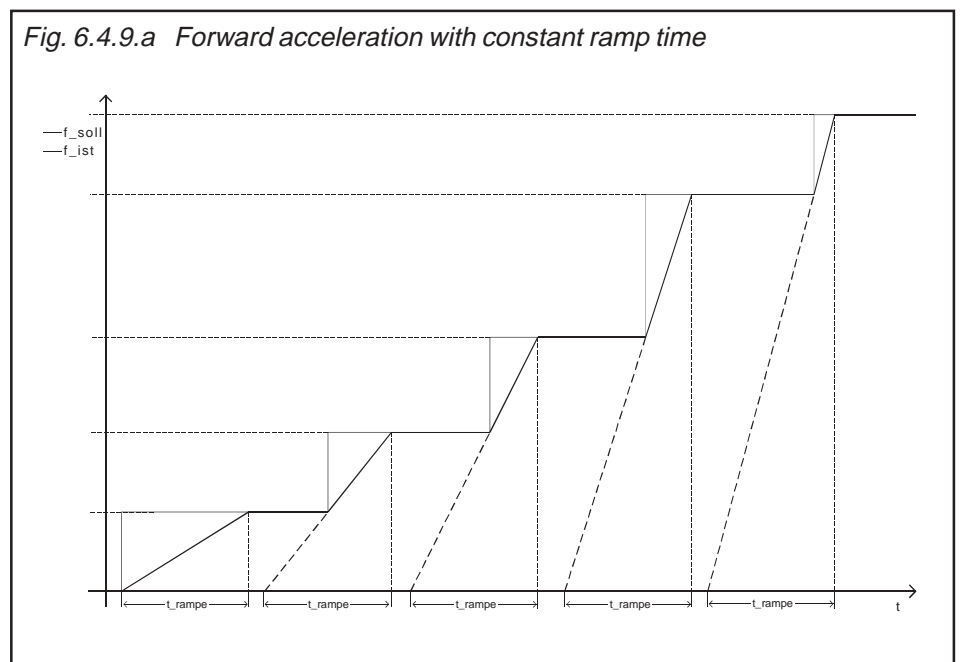
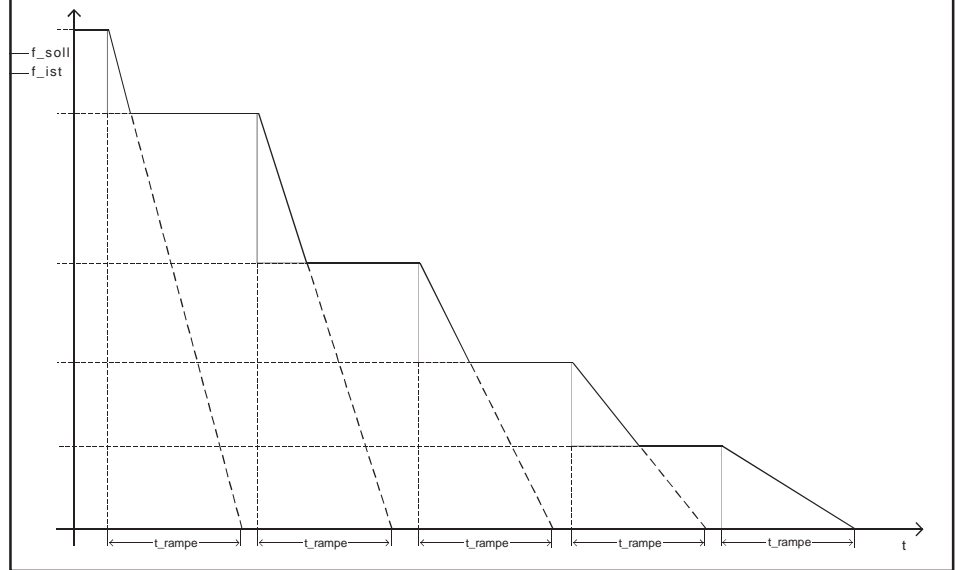


Fig. 6.4.9.b Forward deceleration with constant ramp time

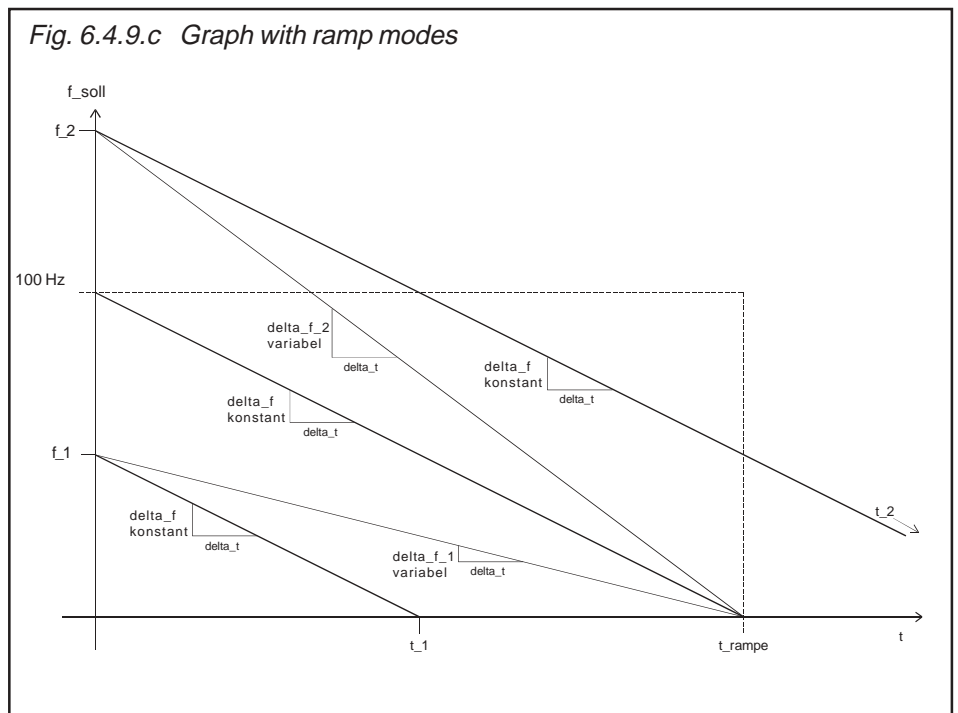


Ramp mode (oP.27) The different ramp functions can be adjusted separately for every frequency change (acceleration forward, deceleration forward and so on). The selection is made with oP.27 and is adjustable separately in each set. The function is activated after pressing „ENTER“.

Ramp	Bit-No	Value	Mode	Reference frequency
Acc. forward	0 + 1	0	const. ascent	100 Hz (dep. of ud.2)
		1	const. time	actual set value
		2	*const. time	last set value at constant run
		3	reserved	
Dec. forward	2 + 3	0	const. ascent	100 Hz (dep. of ud.2)
		4	*const. time	actual set value
		8	const. time	last set value at constant run
		12	reserved	
Acc. reverse	4 + 5	0	const. ascent	100 Hz (dep. of ud.2)
		16	const. time	actual set value
		32	*const. time	last set value at constant run
		48	reserved	
Dec. reverse	6 + 7	0	const. ascent	100 Hz (dep. of ud.2)
		64	*const. time	actual set value
		128	const. time	last set value at constant run
		192	reserved	

* Do not adjust these values - they are only sensible, if acceleration does not take place from standstill or deceleration is not made to standstill.

If the mode constant time is activated for a ramp, then the s-curve function is deactivated for this ramp. The ascent is limited to minimum 100 Hz / 4800 s.



Calculations

The frequency change per raster scan Δt (step size Δf) for the mode constant ascent is calculated from the ramp time t_{ramp} and the reference frequency (100 Hz dependent on ud.2) as follows:

$$\Delta f = \frac{100 \text{ Hz}}{t_{\text{rampe}} / \Delta t}$$

For different set values the real ramp time is calculated according to following formula:

$$t = t_{\text{ramp}} * \frac{f_{\text{set}}}{100 \text{ Hz}}$$

The actual step size for the mode constant time is calculated from the step size Δf and the actual set value f_{set} as follows:

$$\Delta f(\text{variabel}) = \Delta f * \frac{f_{\text{set}}}{100 \text{ Hz}}$$

For the simplification of the internal calculation as frequency reference 102.4 Hz (e.g. 204.8 Hz or 409.6 Hz dependent on ud.2) is used :

$$\Delta f(\text{variabel}) = \Delta f * \frac{f_{\text{set}}}{102.4 \text{ Hz}}$$




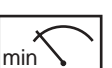




As a result an error of -2,4 % for the real ramp time occurs. If a certain real ramp time has to be adjusted, the desired value must be divided by 1.024.

Example:

desired ramp time = 10 s

adjusted ramp time = 10 s / 1.024 = 9.77 s

6.4.10 Used Parameters

Param.	Adr.								
oP.0	0300h	✓	✓	✓	0	9	1	0	-
oP.1	0301h	✓	✓	✓	0	9	1	2	-
oP.2	0302h	✓	✓	✓	0	2	1	0	-
oP.3	0303h	✓	✓	-	-400 Hz	400 Hz	0,0125 Hz	0 Hz	dependent on ud.2
oP.5	0305h	✓	✓	-	-100 %	100 %	0,1 %	0,0 %	-
oP.6	0306h	✓	✓	-	0 Hz	400 Hz	0,0125 Hz	0 Hz	dependent on ud.2
oP.7	0307h	✓	✓	-	-0,0125 Hz	400 Hz	0,0125Hz	-0,0125 Hz	-0,0125 Hz: =For
oP.10	030Ah	✓	✓	-	0 Hz	400 Hz	0,0125 Hz	70 Hz	dependent on ud.2
oP.11	030Bh	✓	✓	-	-0,0125 Hz	400 Hz	0,0125Hz	-0,0125 Hz	-0,0125Hz: =For
oP.14	030Eh	✓	✓	-	0 Hz	400 Hz	0,0125 Hz	200 Hz	dependent on ud.2
oP.15	030Fh	✓	✓	-	-0,0125 Hz	400 Hz	0,0125Hz	-0,0125 Hz	-0,0125Hz: =For
oP.18	0312h	✓	✓	✓	0	9	1	2	-
oP.19	0313h	✓	-	✓	0	4095	1	16	-
oP.20	0314h	✓	-	✓	0	4095	1	32	-
oP.21	0315h	✓	✓	-	-400 Hz	400 Hz	0,0125 Hz	5 Hz	dependent on ud.2
oP.22	0316h	✓	✓	-	-400 Hz	400 Hz	0,0125 Hz	50 Hz	dependent on ud.2
oP.23	0317h	✓	✓	-	-400 Hz	400 Hz	0,0125 Hz	70 Hz	dependent on ud.2
oP.27	031Bh	✓	✓	✓	0	255	1	0	-
oP.28	031Ch	✓	✓	-	0,00 s	300,00 s	0,01 s	5,00 s	-
oP.29	031Dh	✓	✓	-	-0,01 s	300,00 s	0,01 s	-0,01 s	-0,01 s =For
oP.30	031Eh	✓	✓	-	-0,01 s	300,00 s	0,01 s	5,00 s	-0,01 s: =Acc
oP.31	031Fh	✓	✓	-	-0,01 s	300,00 s	0,01 s	-0,01 s	-0,01 s: = For
oP.32	0320h	✓	✓	-	0,00 s	5,00 s	0,01 s	0,00 s	0,00 s = off
oP.33	0321h	✓	✓	-	-0,01 s	5,00 s	0,01 s	-0,01 s	-0,01 s: =For; 0.00 s = off
oP.34	0322h	✓	✓	-	-0,01 s	5,00 s	0,01 s	-0,01 s	-0,01 s: =Acc; 0.00 s = off
oP.35	0323h	✓	✓	-	-0,01 s	5,00 s	0,01 s	-0,01 s	-0,01 s: =For; 0.00 s = off
oP.36	0324h	✓	✓	-	0 Hz	400 Hz	0,0125 Hz	0 Hz	dependent on ud.2
oP.37	0325h	✓	✓	-	-0,0125 Hz	400 Hz	0,0125 Hz	-0,0125 Hz	-0,0125Hz: =For; dep. on ud.2
oP.40	0328h	✓	✓	-	0 Hz	400 Hz	0,0125 Hz	400 Hz	dependent on ud.2
oP.41	0329h	✓	✓	-	-0,0125 Hz	400 Hz	0,0125Hz	0,0125 Hz	-0,0125Hz: =For; dep. on ud.2
oP.60	033Ch	✓	-	✓	0	4095	1	4	-
oP.61	033Dh	✓	-	✓	0	4095	1	8	-
SY.52	0034h	✓	-	-	-16000 rpm	16000 rpm	1 rpm	0 rpm	-

1. Introduction

2. Summary

3. Hardware

4. Operation

5. Parameter

6. Functions

7. Start-up

8. Special Operation

9. Error Assistance

10. Project Planning

11. Networks

12. Annex

6.1 Operating and Appli-
cance Date

6.2 Analog In- and Outputs

6.3 Digital In- and Outputs

6.4 Set Value and Ramp
Adjustment

**6.5 Voltage-/Frequency
Characteristic (U/f)
Adjustment**

6.6 Motor Data Adjustment

6.7 Protective Functions

6.8 Parameter Sets

6.9 Special Functions

6.10 Encoder Interface

6.11 SMM, Posi, Synchron

6.12 Technology Control

6.13 CP-Parameter Definition

6.5.1	Control type and Max. Frequency Mode	3
6.5.2	Rated frequency and Boost	4
6.5.3	Additional Rated Point	4
6.5.4	Delta Boost	4
6.5.5	Voltage Stabilization	5
6.5.6	Maximal Voltage Mode	6
6.5.7	Switching Frequency	6
6.5.8	Used Parameters	7

Chapter 6	Section 5	Page 2	Date 17.04.02	Name: Basis KEB COMBIVERT F5	© KEB Antriebstechnik, 2002 All rights reserved
---------------------	---------------------	------------------	------------------	--	--


6.5 Voltage-/ Frequency Characteristic Adjustment

In the following chapter all parameters for the adjustment of the voltage/frequency characteristic as well as the appropriate adjustments like modulation, voltage rise (Boost) and switching frequency are described. Except for the switching frequency these adjustments apply only to F5-B, F5-G and F5-M in controlled operation (CS.0=off).

6.5.1 Control Type (ud.2) and Max Frequency Mode (only F5-B)

This parameter depends in the value range on the used control. The values 0...2 apply to open loop systems (F5-B and F5-G), the values 4...6 to closed loop systems (F5-M) and the values 7...10 to servos (F5-S). For these units a separate instruction manual is available, for that reason we do not go into details here.

This parameter defines the maximal possible output frequency/speed, the resolution and the reference values for the ramp times, the analog outputs and the dc brake. Changes effect all frequency/speed dependent parameters. The parameter can only be written with opened control release. After a change the initialization is passed through, so that no Power-On-Reset is necessary.

 The switching frequency (uF.11) must be adjusted at least 10times higher than the maximal possible output frequency!

ud.2	Control typ	Maximal frequency	Resolution
0	F5-G/B	400 Hz	0,0125 Hz
1	F5-G/B	800 Hz	0,025 Hz
2	F5-G/B	1600 Hz	0,05 Hz
3	reserved		
4	F5-M	4000 min ⁻¹	0,125 min ⁻¹
5	F5-M	8000 min ⁻¹	0,25 min ⁻¹
6	F5-M	16000 min ⁻¹	0,5 min ⁻¹
7	reserved		
8	F5-S	4000 min ⁻¹	0,125 min ⁻¹
9	F5-S	8000 min ⁻¹	0,25 min ⁻¹
10	F5-S	16000 min ⁻¹	0,5 min ⁻¹

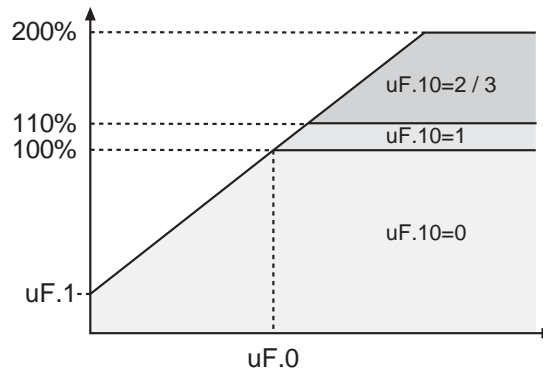
For every frequency mode COMBIVIS uses an own Config-File. In the case of a mode changeover all parameter information are read from the inverter and a new Config-File is generated should it not already exist.

6.5.2 Rated frequency (uF.0) and Boost (uF.1)

The voltage/frequency characteristic (U/f) is adjusted with the rated frequency (uF.0) and the Boost (uF.1). The rated frequency adjusts the frequency at which 100 % modulation depth (~input voltage) are achieved. The boost adjusts the output voltage to 0 Hz. Depending on uF.10 the modulation limit can be further increased in this stage up to 200 % (see Fig. 6.5.2).

Fig. 6.5.2 Rated frequency and Boost

uF.0 = 0.0000...400.00 Hz; Default = 50 Hz
 uF.1 = 0.0...25.5 %; Default = PU-Id

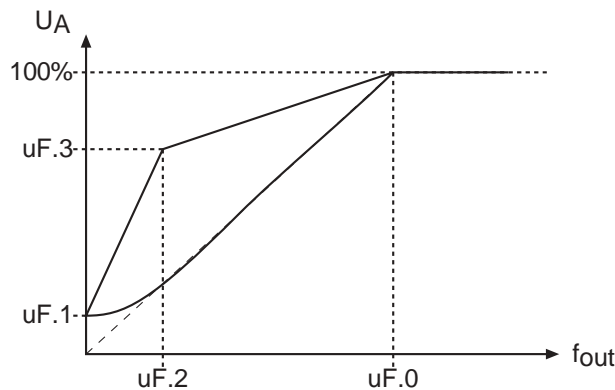


6.5.3 Additional Rated Point (uF.2/uF.3)

To adapt the U/f-characteristic to special conditions an additional point of support can be specified with uF.2 and uF.3. uF.2 defines the frequency and uF.3 the voltage. At uF.2 = 0 Hz the adjustment is ignored.

Bild 6.5.3 Additional Rated Point

uF.2 = -0,0125 = parabolic characteristic
 0,0...400 Hz; Default = 0,0 Hz
 uF.3 = 0,0...100,0 %; Default = 0,0 %

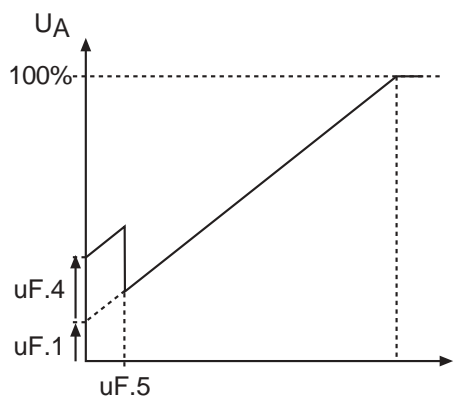


6.5.4 Delta Boost (uF.4/ uF.5)

The Delta-Boost is a time-limited Boost used to overcome large breakaway torques. The Delta-Boost acts adding to the Boost; but the sum is limited to 25.5 %.

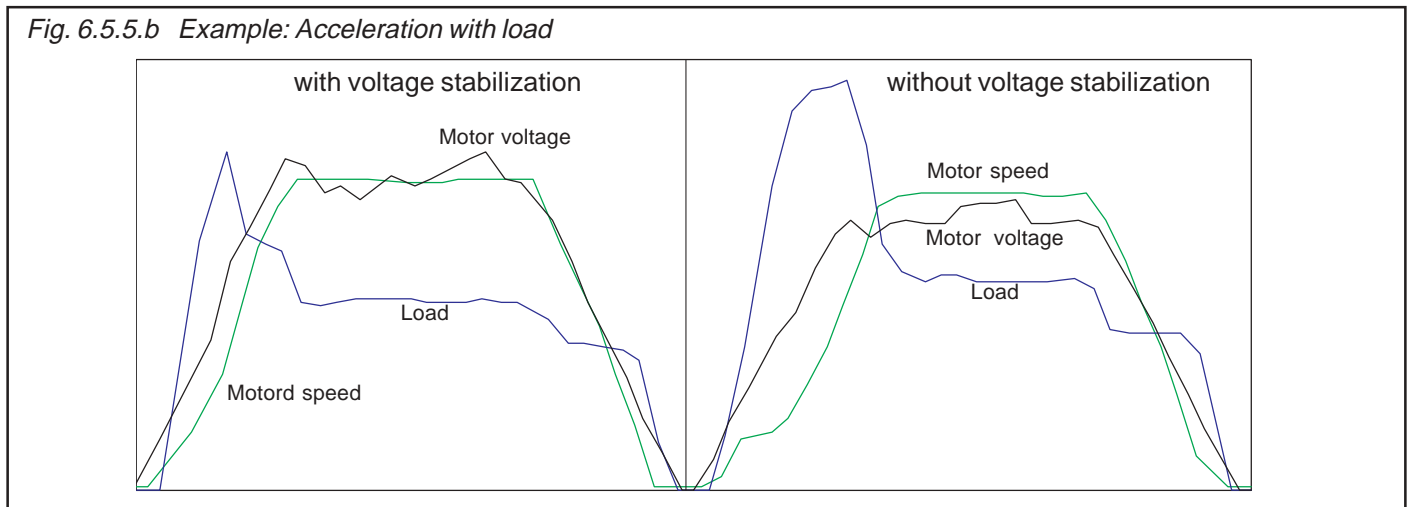
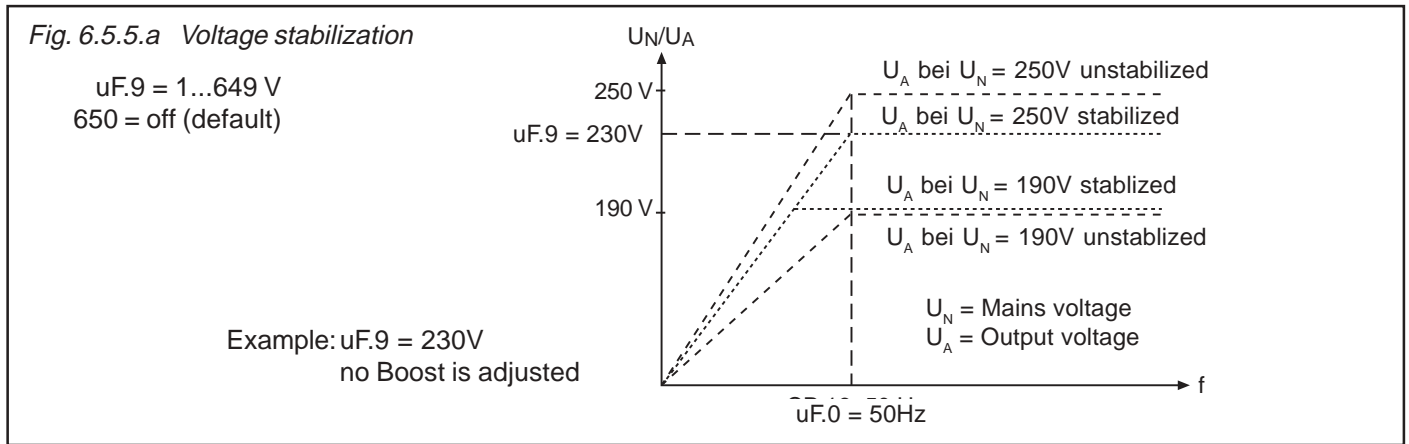
Fig. 6.5.4 Delta Boost

uF.4 = 0.0...25.5 %; Default = 0 %
 uF.5 = 0.00...10.00 s; Default = 0 s



6.5.5 Voltage Stabilization (uF.9)

Due to fluctuations of the mains voltage or the load the DC-link voltage and with it the directly dependent output voltage can change. In the case of enabled voltage stabilization the fluctuations of the output voltage are compensated. That means 100% output voltage correspond to the value adjusted in uF.9, but maximally 110 % · (DC-link voltage / $\sqrt{2}$). Furthermore, this function makes it possible to adapt motors with a smaller rated current to the inverter.



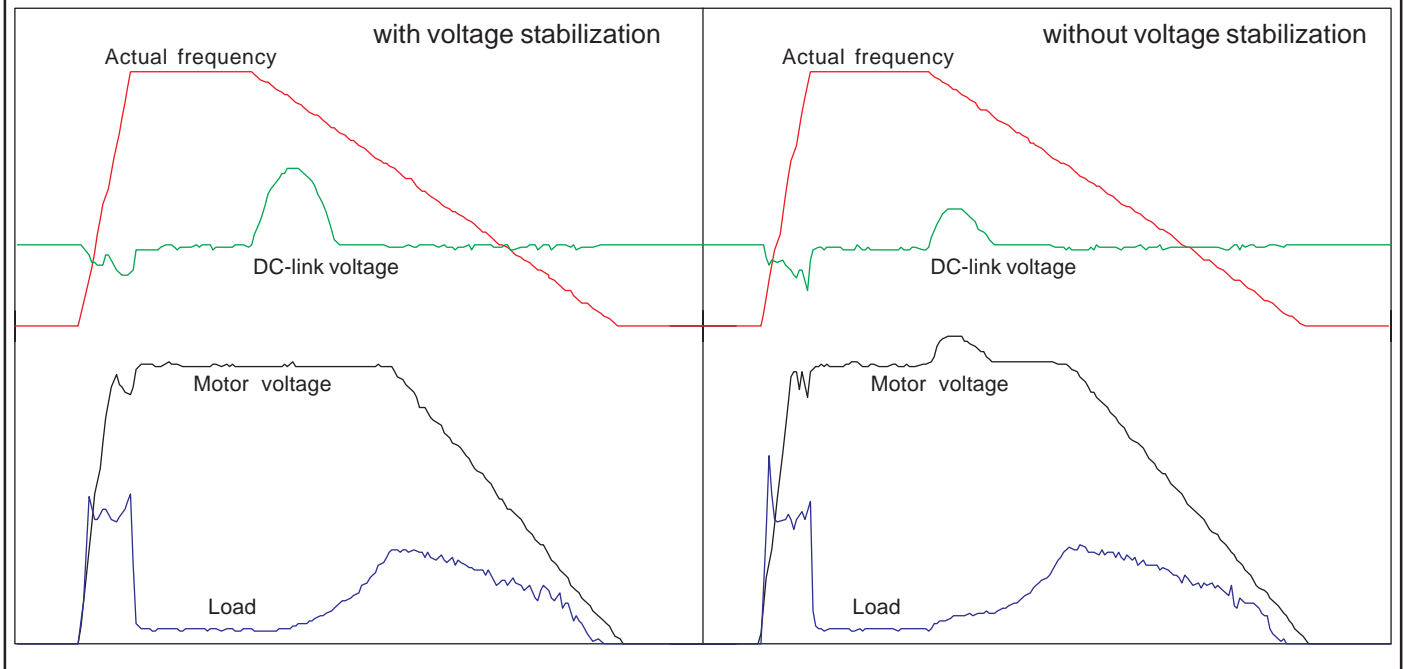
Voltage stabilization PT1-time constant (uF.19)

(only for F5-G >= D-housing)

With uF.19 the time constant of a PT1-element is defined. The PT1-element serves for the smoothing of the DC-link voltage. The initial value of the PT1-element is used as actual value for the voltage stabilization.

uF.19	PT1-time constant
0	Function off
1	2 ms
2	4 ms
3	8 ms
4	16 ms
5	32 ms
6	64 ms
7	128 ms
8	256 ms
9	512 ms
10	1024 ms

Fig. 6.5.5.c Example: Deceleration of a centrifugal-load drive from 80Hz



6.5.6 Maximal voltage mode (uF.10)


By changing the maximal voltage mode more torque can be released free above the rated frequency through overmodulation (110% voltage). Raising the U/f-characteristic has an influence at activated energy saving function or at voltage stabilization.

uF.10	Modulation	Description
0	100 % U/f / 100% voltage	without overmodulation; all limitations 100% of modulation factor
1	110 % U/f / 110% voltage	with overmodulation; all limitations 110% of modulation factor
2	200 % U/f / 100% voltage	limitations between voltage-forming functions 200%; limitation before modulator 100% of modulation factor
3	200 % U/f / 110% voltage	limitations between voltage-forming functions 200%; limitation before modulator 110% of modulation factor

6.5.7 Switching Frequency (uF.11)

The switching frequency with which the power modules are clocked, can be changed depending on the application. The maximal possible switching frequency as well as the factory setting are determined by the employed power circuit.

uF.11 Switching frequency		
Combivis	Display/Plaintext	Frequency
0	2	2 kHz
1	4	4 kHz
2	8	8 kHz
3	12	12 kHz
4	16	16 kHz

 At switching frequencies above 4 kHz absolutely consider the max. motor line length specified in chapter 2.1.6 and 2.1.7.

The current switching frequency is indicated in the parameter ru.45, the max. switching frequency in ln.3 and the switching carrier frequency in ln.4.

Influences and effects of the switching frequency are listed below:

small switching frequency	high switching frequency
<ul style="list-style-type: none"> - less inverter heating - less discharge current - fewer switching losses - fewer radio interferences - improved concentricity at small speeds 	<ul style="list-style-type: none"> - less noise development - improved sine-wave simulation - less motor losses

6.5.8 Used Parameters

Param.	Adr.	R/W	PROG.	ENTER	min	max	Step	default	
ud.2	0802h	✓	-	-	0	10	1	0/4/8	default value dep. on ud.2
uF.0	0500h	✓	✓	-	0 Hz	400 Hz	0,0125 Hz	50,0 Hz	depending on ud.2
uF.1	0501h	✓	✓	-	0,0 %	25,5 %	0,1 %	2,0 %	-
uF.2	0502h	✓	✓	-	-0,0125 Hz	400 Hz	0,0125 Hz	0,0 Hz	dep. on ud.2; -0,0125 = parabolic
uF.3	0503h	✓	✓	-	0,0 %	100,0 %	0,1 %	0,0 %	-
uF.4	0504h	✓	✓	-	0,0 %	25,5 %	0,1 %	0,0 %	-
uF.5	0505h	✓	✓	-	0,00 s	10,00 s	0,01 s	0,00 s	-
uF.9	0509h	✓	✓	-	1 V	649 V; 650: off	1 V	650:off	-
uF.10	050Ah	✓	✓	-	0	3	1	0	-
uF.11	050Bh	✓	✓	-	0	PU-Id	1	PU-Id	PU-Id: Power unit Identification
uF.19	0513h	✓	-	-	0	10	1	0	-

Chapter 6	Section 5	Page 8	Date 17.04.02	Name: Basis KEB COMBIVERT F5	© KEB Antriebstechnik, 2002 All rights reserved
---------------------	---------------------	------------------	------------------	--	--

1. Introduction

2. Summary

3. Hardware

4. Operation

5. Parameter

6. Functions

7. Start-up

8. Special Operation

9. Error Assistance

10. Project Planning

11. Networks

12. Annex

6.1 Operating and Appli-
cance Date

6.2 Analog In- and Outputs

6.3 Digital In- and Outputs

6.4 Set Value and Ramp
Adjustment

6.5 Voltage-/Frequency
Characteristic (U/f)
Adjustment

6.6 Motor Data Adjustment

6.7 Protective Functions

6.8 Parameter Sets

6.9 Special Functions

6.10 Encoder Interface

6.11 SMM

6.12 Technology Control

6.13 CP-Parameter Definition

6.6.1	Motor Name Plate	3
6.6.2	Motor Data from Name Plate ..	3
6.6.3	Motor Data from Data Sheets .	4
6.6.4	Motor Stator Resistance	4
6.6.5	Used Parameters	6

Chapter 6	Section 6	Page 2	Date 23.01.02	Name: Basis KEB COMBIVERT F5-G / B	© KEB Antriebstechnik, 2002 All rights reserved
---------------------	---------------------	------------------	------------------	--	--

6.6 Motor Data Adjustment

The adjustment of the correct motor data is important for many inverter functions, since calculations are derived from it, which the inverter requires to achieve the best possible results in the control of Boost and slip compensation.

6.6.1 Motor Name Plate

Fig. 6.6.1 Example of a motor name plate

		KEB Antriebstechnik GmbH & Co. KG		Made in Germany	
Schneeberg					
DK 160 L 4 F I /TW150				CE	
96/1632804/ 001					
dr.3	3 -Mot	IP 55	IM B 3	W.Kl. F	40 °C
dr.2	127 kg				
VDE 053 0					
dr.5	15,0 KW				
dr.4	50 Hz	230/400	V Δ/Y		
dr.1	cos φ	0,86	49,5/28,5	A	
dr.0		1455	1/min	IGR 05B	2500 Imp
		5V D0/RS		6xTTL	
U _{FL}		230/400	V		
3 ~Mot	50	Hz	M _{Br}	Nm	I _{Sp max} mm

6.6.2 Motor Data from the Name Plate (dr.0...dr.5)

Following parameters can be taken directly from the name plate (see above) and entered:

- dr.0 Rated motor current 0.0...710.0 A (Star-/Delta-connection)
- dr.1 Rated motor speed 0...64000 rpm
- dr.2 Rated motor voltage 120...500 V (Star-/Delta-connection)
- dr.3 Rated motor power 0.35...400.00 kW
- dr.4 Rated motor power factor cos(phi) 0.00...1.00
- dr.5 Rated motor frequency 0...1600.0 Hz



Parameter dr.0 and dr.2 are always to be adjusted according to the used wiring (star/delta). For above stated motor name plate that is 230 V / 49.5 A at delta-connection and 400 V / 28.5 at star-connection

6.6.3 Motor Data from Data Sheets (dr. 9)

Usually the breakdown torque factor (M_K/M_N) is not included in the motor rating plate. This data is found in the corresponding data sheet or the motor catalog. For KEB standard motors (4-pole) the information is listed in the following table:

kW	0,37	0,75	1,1	1,5	2,2	3,0	4,0	5,5	7,5
M_K/M_N	2,2	2,3	2,5	2,6	3,1	2,8	3,2	3,0	2,9

kW	11,0	15,0	18,5	22,0	30,0	37,0	45,0	55,0	75,0
M_K/M_N	3,3	3,0	2,9	2,6	2,4	2,5	2,5	2,3	2,2

kW	90,0	110,0	132,0	160,0	200,0	250,0	315,0	
M_K/M_N	2,2	2,2	2,2	2,0	2,4	2,3	2,5	

If the motor stator resistance is taken from a data sheet, then there is usually $R_{1_{20}}$ - equivalent resistance (phase value) specified. Depending on the used connection the following value must be adjusted in dr.6:

Star connection: $dr.6 = 2 \cdot R_{1_{20}}$ to $2,24 \cdot R_{1_{20}}$
 Delta connection: $dr.6 = 0,666 \cdot R_{1_{20}}$ to $0,75 \cdot R_{1_{20}}$

If only the warm resistance R_w is specified:

Star connection: $dr.6 = 1,4 \cdot R_w$ to $1,6 \cdot R_w$
 Delta connection: $dr.6 = 0,46 \cdot R_w$ to $0,53 \cdot R_w$

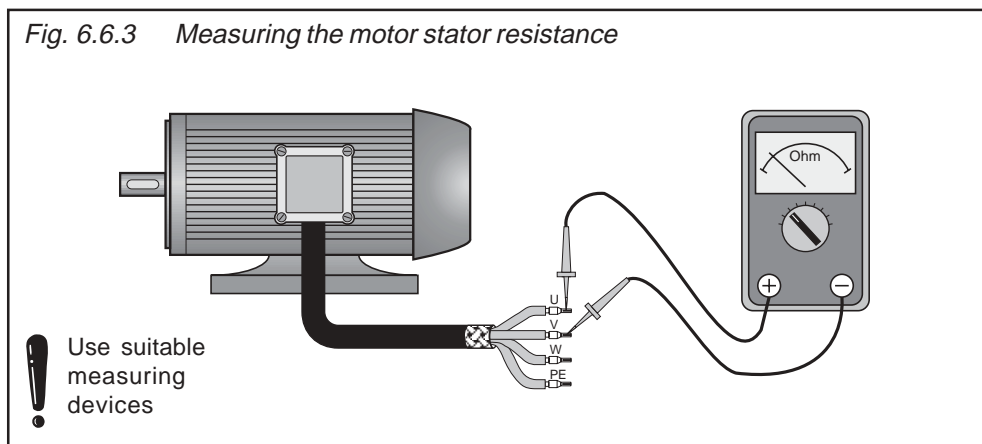
6.6.4 Motor Stator Resistance (dr.6)

The motor stator resistance is measured independent of the motor wiring (Δ / Y) with a warm motor between 2 phases of the motor incoming line. To obtain a more exact result all 3 values (U/V, U/W and V/W) can be measured and the average value be formed.

In this way the ohmic line resistance is registered simultaneously (important in the case of long incoming lines).

! If the measured resistance should be larger than the maximal value, the maximal value is to be adjusted.

Fig. 6.6.3 Measuring the motor stator resistance



Standard values, if no suitable measuring equipment is available!

230V / 400V-motors in Δ-connection			230V / 400V-motors in Y-connection 400V / 690V-motors in Δ-connection	
P/kW	R/Ω (dr.6)	R/Ω (dr.6)	P/kW	R/Ω (dr.6)
0.37	14.0	42.0	5.5	2.2
0.55	12.0	36.0	7.5	1.5
0.75	9.0	27.0	11.0	0.9
1.1	5.5	16.5	15.0	0.6
1.5	3.5	10.5	18.5	0.45
2.2	2.5	7.5	22.0	0.36
3.0	1.5	4.5	30.0	0.24
4.0	1.1	3.3	45.0	0.15
			55.0	0.12
			75.0	0.09

Automatic determination of the motor stator resistance

The KEB COMBIVERT supports an automatic determination of the motor stator resistance. For that proceed as follows:

- input motor data of the identification plate into the parameter set which is to programm.
- select and activate the parameter set which is to programm.
- Execute the measurement dependent on the operational case in cold status respectively let the motor warm up to operating temperature.
- Switch control release
- Preset no direction of rotation (inverter must be in status „LS“)
- Write maximal value „50.000“ to parameter dr.6

During the determination the status display (ru.0) indicates „Cdd“. Upon successful determination the motor stator resistance is entered in dr.6. If an error occurs during the determination then the error signal „E.Cdd“ is output. The detection can be carried out for each parameter set separately. Thus a parameter set can be programmed for example as „Warm-up set“ for particularly critical applications.

Load motor dependent parameters (Fr.10)

After input of the name plate data of a new motor or after the automatic measurement of the stator resistance, an automatic optimization of autobost and slip compensation can be executed with Fr.10.




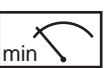




The optimization is started by writing value „3“ on Fr.10. At that the inverter must be in the status „noP“ (no control release. Provided that only one motor is used, the measurement can occur with direct set programming for all parameters at once.

Following parameters are changed by the activation of Fr.10:

- uF.0 Rated frequency = Rated motor frequency (dr.5)
- uf.1 Boost = calculated value
- uF.2 Additional Frequency = -0,0125 Hz (parabolic characteristic)
- uF.3 Additional Voltage = 0
- uF.9 Voltage stabilization = Rated motor voltage (dr.2)
- uF.16 Autobost configuration = 1 (with sign)
- uF.17 Autobost gain = 1,2
- cS.0 Speed control configuration = 34 (speed controller + slip limitation)
- cS.1 Actual Source = 2 (calculated)
- cS.4 speed controller frequency limitation= 4 • rated motor slip

The adaption should cover approx. 90 % of the applications. For an application-specific adjustment a manual fine adjustment can now still be carried out for an individual case.

6.6.5 Used Parameters

Param.	Adr.								
dr.0	0600h	✓	✓	-	0,0 A	710,0 A	0,1 A	P-ID*)	max. 25,5 A at B-housing
dr.1	0601h	✓	✓	-	0 rpm	64000 rpm	1 rpm	P-ID*)	-
dr.2	0602h	✓	✓	-	120 V	500 V	1 V	P-ID*)	-
dr.3	0603h	✓	✓	-	0,35 kW	400,00 kW	0,01 kW	P-ID*)	-
dr.4	0604h	✓	✓	-	0,50	1,00	0,01	P-ID*)	-
dr.5	0605h	✓	✓	-	0,0 Hz	1600,0 Hz	0,1 Hz	P-ID*)	-
dr.6	0606h	✓	✓	-	0,000 Ohm	50,000 Ohm	0,001 Ohm	P-ID*)	50 Ohm start automatic determination
dr.9	0609h	✓	✓	-	0,5	4,0	0,1	2,5	-
Fr.10	090Ah	✓	✓	✓	3	3	1	3	-

*) dependent on the power circuit identification

1. Introduction

2. Summary

3. Hardware

4. Operation

5. Parameter

6. Functions

7. Start-up

8. Special Operation

9. Error Assistance

10. Project Planning

11. Networks

12. Annex

6.1 Operating and Appliance Date

6.2 Analog In- and Outputs

6.3 Digital In- and Outputs

6.4 Set Value and Ramp Adjustment

6.5 Voltage-/Frequency Characteristic (U/f) Adjustment

6.6 Motor Data Adjustment

6.7 Protective Functions

6.8 Parameter Sets

6.9 Special Functions

6.10 Encoder Interface

6.11 SMM, Posi, Synchron

6.12 Technology Control

6.13 CP-Parameter Definition

6.7.1 Ramp Stop and Hardware Current Limit	3
6.7.2 Maximal Constant Current	5
6.7.3 Automatic Restart and Speed Search	7
6.7.4 Dead Time Compensation	9
6.7.5 Base-Block Time and Voltage Level	9
6.7.6 Response to Errors or Warning Signals	9
6.7.7 Fast Stop	13
6.7.8 Motor Protection Mode	15
6.7.9 GTR7-Control	19
6.7.10 Special Functions	20

6.7 Protective Functions

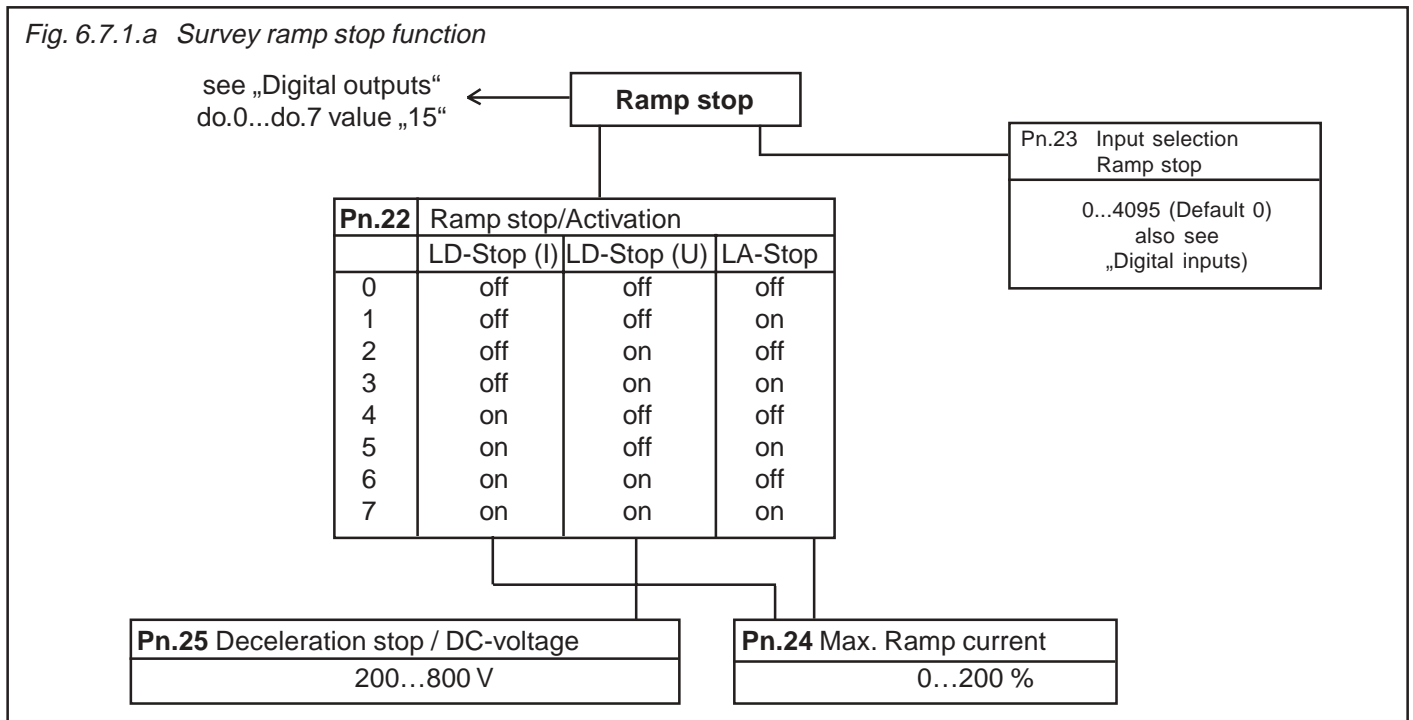
6.7.1 Ramp Stop and Hardware Current Limit

The protective functions protect the inverter against switch off caused by overcurrent, overvoltage as well as thermal overheating. Furthermore, you can restart the drive after an error automatically (Keep-On-Running).

The ramp stop function essentially fulfills two tasks. It prevents

- overcurrent errors (E.OC) during the acceleration phase,
- overvoltage and overcurrent errors (E.OC/E.OP) during the deceleration phase,

by stopping the ramp on exceeding adjustable levels. Moreover, the ramp stop function can be activated by a digital input. Beyond that a hardware current limit is integrated which intervenes independent of the software and is thus much faster. Although these functions can be activated in controlled operation, this is to be avoided, since the KEB COMBIVERT regulates here at the torque limits.



LA-Stop The function protects the frequency inverter against switch off caused by overcurrent during the acceleration phase. The current level is adjustable with Pn.24 in the range of 0...200 %. The protective function can be deactivated with Pn.22.

LD-Stop During deceleration energy is refed into the frequency inverter, which causes a rise of the DC-link voltage. If too much energy is refed the inverter can trip to error OP or OC. If the LD-Stop function is activated with Pn.22, the DEC-ramp is regulated according to the adjusted DC-link voltage (Pn.25) or the DC-link current (Pn.24), so that errors are avoided to a large extent.

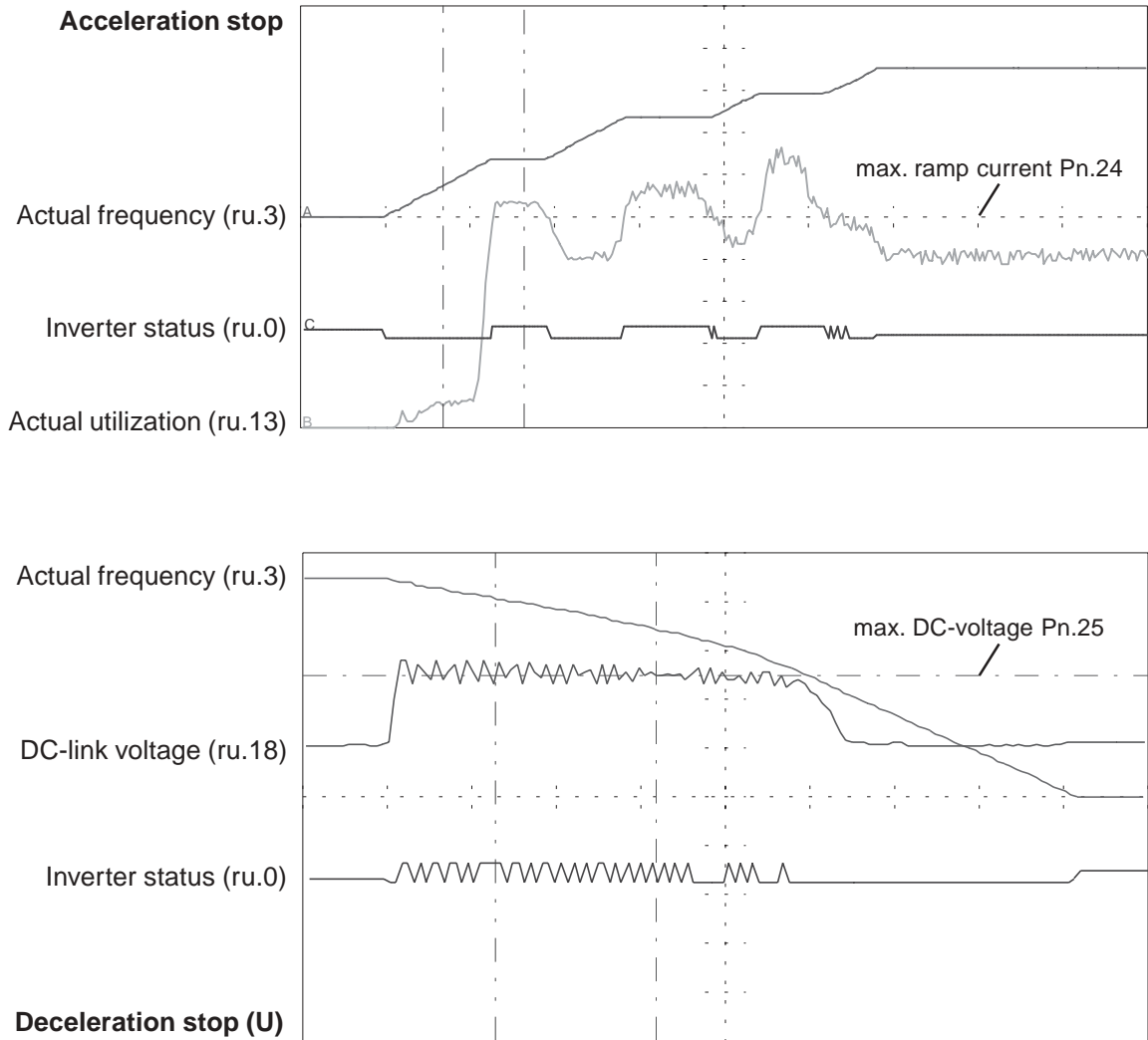
Hardware current limit

! The hardware current limit limits the current at the limit and triggers no error. This can lead to torque breakdowns at the motor shaft, which is especially important during the operation „lifting and lowering“ since the drive can sag because of missing torque without the brake engaging.

The hardware current limit is an additional, fast protection to prevent faults caused by overcurrent. Upon exceeding the max. short-time current limit (see Power Circuit Instruction Manual) the hardware current limit becomes active. The following settings are possible with uF.15:

0	off; Hardware current limit disabled
1	Single phase mode; Hardware current limit enabled; works both in motoric and generatoric operation
2	Zero vektor mode; Hardware current limit enabled; works only motoric, but at activated function it makes available more torque. Generatoric operation switches to Mode 1.

Fig. 6.7.1.b Example for ramp stop function



Used Parameters

Param.	Adr.	R/W	PROG.	ENTER	min	max	Step	default	
Pn.22	0416h	✓	✓	✓	0	7	1	1	bit-coded
Pn.23	0417h	✓	-	✓	0	4095	1	0	-
Pn.24	0418h	✓	✓	-	0 %	200 %	1 %	140 %	% referring to inverter rated current
Pn.25	0419h	✓	✓	-	200 V	800 V	1 V	375/720 V	depending on voltage class
uF.15	050Fh	✓	-	-	0	2	1	1	-

6.7.2 Current Limit Constant Run (Stall-Function)

Pn.19 Stall mode

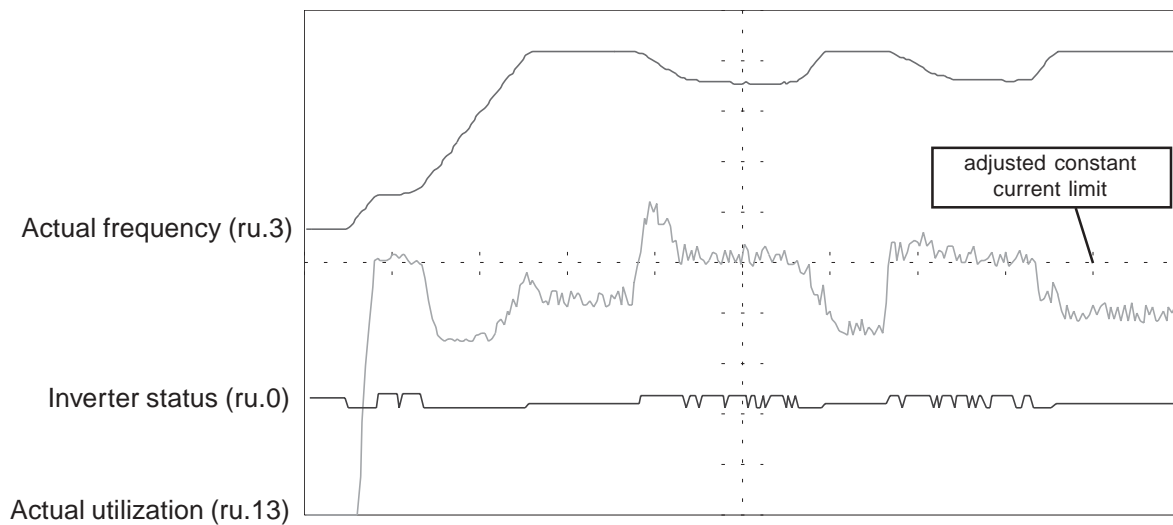
The Stall-function protects the frequency inverter against overload. Upon reaching the maximal constant current the utilization is reduced by increasing/decreasing the output frequency. When falling below the maximal constant current the inverter accelerates/ decelerates again with the normal ramp time. These adjustments apply only to F5-B, F5-G and F5-M in controlled operation (CS.0=off). The basic mode of operation is determined with Pn.19:

Binäry	dec.	Description
Bit 0/1		Final value to which deceleration/acceleration takes place. Both limits are always adjusted as the control direction may be inverted during generative operation.
xxxxxx00	0	decelerates to oP.6/oP.7
xxxxxx01	1	accelerates to oP.10/oP.11
xxxxxx10	2	oP.36/oP.37
xxxxxx11	3	oP.6/oP.7 oP.40/oP.41 oP.36/oP.37 oP.40/oP.41
Bit 2		With this bit one adjusts whether the control direction inverts itself during generative operation.
xxxxx0xx	0	Control direction independent on active current
xxxxx1xx	4	Control direction is inverted in the case of negative active current (generative operation)
Bit 3		This bit determines the control mode.
xxxx0xxx	0	The frequency is increased/decreased by way of the ramp generator. The ramp time is preset by Pn.21.
xxxx1xxx	8	The frequency is increased/decreased by a setpoint/actual-value differential controller. The time constant of the controller is preset by Pn.21, the setpoint is preset by Pn.20.
Bit 4		Determines when the stall controller should intervene,
xx0xxxxx	0	Stall-controller only active during constant running factual=fset (status ru.0: fcon or rcon)
xx1xxxxx	16	Stall-controller generally on
Bit 5		Determines which actual value serves for the control
x0xxxxxx	0	Apparent current (default)
x1xxxxxx	32	Active current; this setting in combination with Bit3 = „1“ is necessary for generative operation (at F5-B = value 0)
Bit 6		Determines the torque/speed characteristic of the Stall-function.
0xxxxxxx	0	Positive characteristic, e.g. for fans, the frequency must be reduced so that the utilization decreases.
1xxxxxxx	64	Negative characteristic, e.g. for drilling machines, the frequency must be increased so that the utilization decreases.
Bit 7		Current limitation calculation above the rated point
0xxxxxxx	0	No current limitation calculation
1xxxxxxx	128	Current limitation calculation above the rated point. Above the rated point (uf.0) the Stall-level (Pn.20) is lowered according to following formula: $\text{Current limit} = \text{Pn.20} \cdot \left(\frac{\text{Rated point (uf.0)}}{\text{Actual freq. (ru.3)}} \right)^2$

Pn.20 Stall level The max. constant current represents the setpoint for the control. The adjusted value refers to the inverter rated current (In.1).
 Setting range: 0...199 %; 200 = off (default)

Pn.21 Stall Acc/Dec time Depending on the setting of Pn.19 (bit 3) the ramp time or the time constant of the differential controller is adjusted here. The adjusted ramp times refer to 100 Hz / 1000 min⁻¹ (depending on ud.2).
 Setting range: 0...300.00 s (2.00 s default)

Fig. 6.7.2 Function of Stall-function with standard setting



Used Parameters

Param.	Adr.	R/W	PROG.	ENTER	min	max	Step	default	
Pn.19	0413h	✓	✓	✓	0	255	1	0	bit-coded
Pn.20	0414h	✓	✓	-	0 %	199 % (200 = oFF)	1 %	oFF	% referring to inverter rated current
Pn.21	0415h	✓	✓	-	0.00 s	300.00 s	0.01s	2.00 s	-

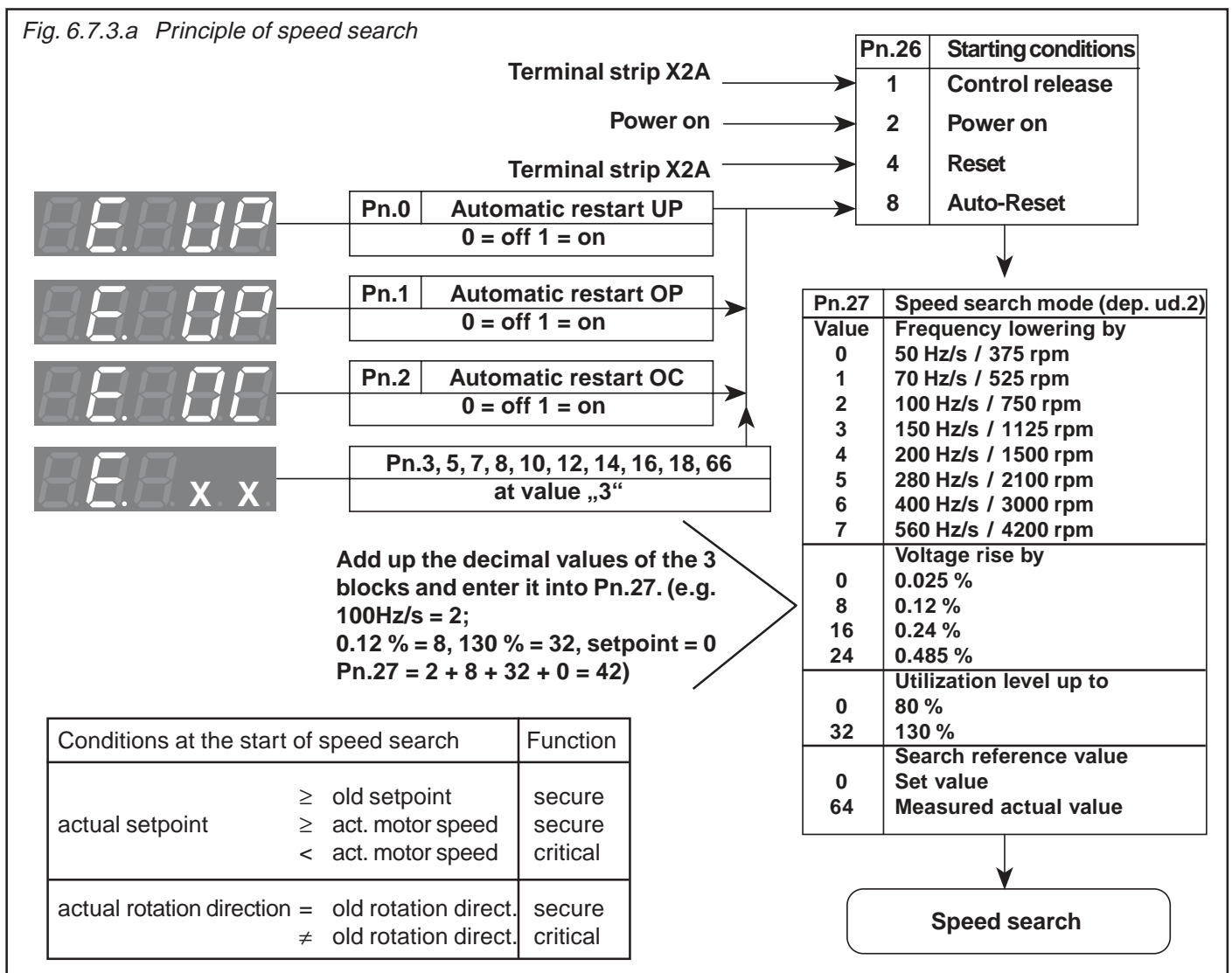
6.7.3 Automatic Restart and Speed Search

With automatic restart the inverter can reset errors automatically. The function can be activated in a separate manner according to error with the Pn-parameters.

! Because of the independent starting of the machine safety measures must be provided for operating personnel and machine.

The function speed search permits the connection of the frequency inverter onto a running out motor. After the function has been activated by the selected starting conditions (Pn.26), it searches for the actual motor speed and adapts the output frequency and voltage accordingly. If the synchronization point is found the inverter accelerates the drive with the adjusted ACC-ramp to the setpoint. In regulated operation the ramp output value is set to the measured actual value.

Fig. 6.7.3.a Principle of speed search



Speed Search / Mode Pn.27

The speed search mode determines the frequency and voltage jumps as well as the maximum utilization with which the function works. Higher values let the function work faster, lower values make the function „softer“.

Fig. 6.7.3.b Speed search with „soft“ adjusted function

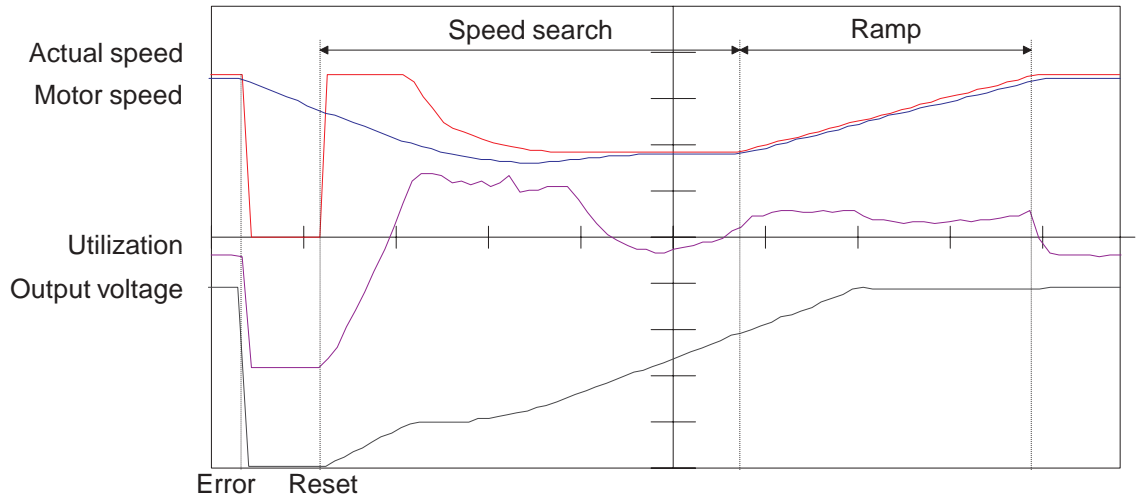
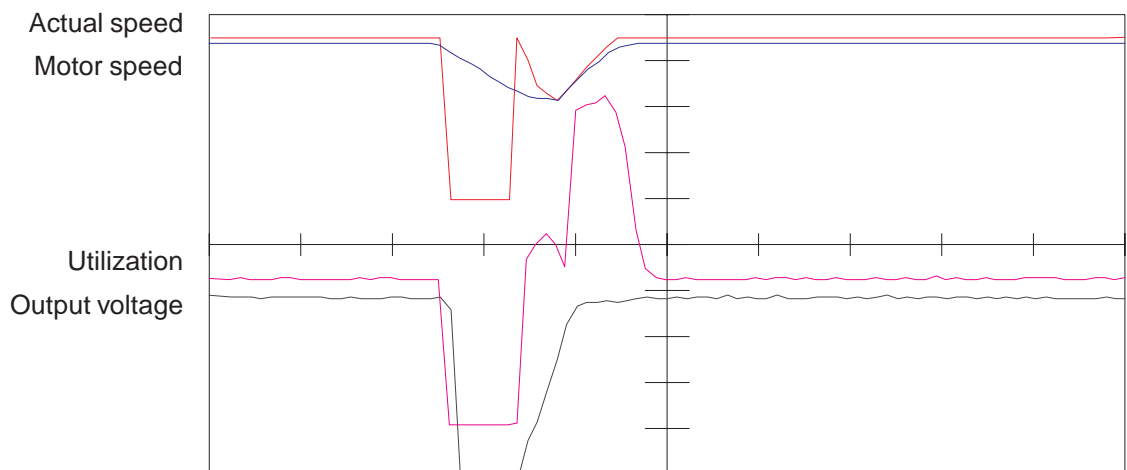


Fig. 6.7.3.c Speed search with „fast“ adjusted function



Used Parameters

Param.	Adr.	R/W	PROG.	ENTER	min	max	Step	default	
Pn.0	0400h	✓	-	-	0	1	1	1	-
Pn.1	0401h	✓	-	-	0	1	1	0	-
Pn.2	0402h	✓	-	-	0	1	1	0	-
Pn.26	041Ah	✓	✓	✓	0	15	1	8	bit-coded
Pn.27	041Bh	✓	-	✓	0	127	1	0	bit-coded

6.7.4 Dead Time Compensation uF.18

The dead time compensation optimizes the switch-off times of the power module semiconductors. The parameter is intended for service purposes only and should not be changed.

uF.18	Dead time compensation/Mode
0	off
1	on (default)

6.7.5 Base-Block Time (uF.12) and Voltage Level (uF.13)

On switching off the modulation (e.g. on opening the control release or triggering the DC-brake) the motor induces a voltage which acts contrary to its cause. The Base-Block time (uF.12 in s) protects the power modules against destruction by blocking the power modules in this stage. The duration of the Base-Block time depends on the power stage. During the Base-Block time the display indicates „bbl“. Below the indicated Base-Block voltage level uF.13 no Base-Block time occurs. The current modulation grade is indicated in ru.42.

6.7.6 Response to Errors or Warning Signal

The following errors or warning signals must not lead automatically to the disconnection of the inverter. The behaviour can be adjusted by parameters:

Pn.4	Input selection external error	=>	Pn.3	Response to external fault
Pn.6	Watchdog time	=>	Pn.5	Response to error watchdog
		=>	Pn.7	Response to limit switch
		=>	Pn.18	Response to set-warning
		=>	Pn.66	Response to soft limit switch

At the following signals one can react to the interference additionally by setting a switching condition:

Pn.9	Level OL-warning	=>	Pn.8	Response to OL-warning
Pn.11	Level OH-warning	=>	Pn.10	Response to OH-warning
Pn.13	Clearing time E.dOH	=>	Pn.12	Response to dOH-warning
	Motor protective circuit-breaker (6.7.8)	=>	Pn.14	Response to OH2-warning
Pn.17	Level OHI-warning	=>	Pn.16	Response to OHI-warning

Input selection external fault (Pn.4)

In order to trigger an error in the inverter with an external signal, one or several inputs can be selected for it with Pn.4.

i With Pn.65 Bit 1 it can be defined, whether with the inputs selected here E.EF (with response from Pn.3) or E.UP (response from 6.7.3) is triggered.

Bit -No.	Decimal value	Input	Terminal
0	1	ST (Prog. input „Control release/Reset“)	X2A.16
1	2	RST (Prog. input „Reset“)	X2A.17
2	4	F (Prog. input „Forward“)	X2A.14
3	8	R (Prog. Input „Reverse“)	X2A.15
4	16	I1 (Prog. Input 1)	X2A.10
5	32	I2 (Prog. Input 2)	X2A.11
6	64	I3 (Prog. input 3)	X2A.12
7	128	I4 (Prog. input 4)	X2A.13
8	256	IA (Internal input A)	none
9	512	IB (Internal input B)	none
10	1024	IC (Internal input C)	none
11	2048	ID (Internal input D)	none

In case of several inputs the sum of their decimal values must be entered.

Response to E.EF (Pn.3) With Pn.3 it is defined how the inverter reacts when an external error (E.EF; A.EF) is triggered. Following reactions can be selected:

Pn.3	Response	Description
0	Error; restart after Reset	Error message E.xx Immediate switch off of modulation. Correct the error for the restart and activate reset. The prewarning changes to an error. The drive remains in the error state until a reset signal is recognized.
1	Fast stop; modulation off; restart after Reset	Status message A.xx Fast stop - switch off of modulation after reaching 0Hz. Correct the error for the restart and activate reset. The drive remains in condition fast stop until a reset signal is recognized.
2	Fast stop; holding torque; restart after Reset	Status message A.xx Fast stop - holding torque on reaching 0 Hz. Correct the error for the restart and activate reset. The drive remains in condition fast stop until a reset signal is recognized.
3	Modulation off; automatic restart	Status message A.xx Immediate switch off of modulation; the drive returns automatically to normal operation, as soon as the fault no longer exists.
4	Fast stop; modulation off; automatic restart	Status message A.xx Fast stop - switch off of modulation after reaching 0Hz. The drive returns automatically to normal operation, as soon as the fault no longer exists.
5	Fast stop; holding torque; automatic restart	Status message A.xx Fast stop - Holding torque on reaching 0 Hz. The drive returns automatically to normal operation, as soon as the fault no longer exists.
6	Protective function off; no reaction	no status message No effect on the drive. Fault is being ignored.

Watchdog-time (Pn.6) The Watchdog-time monitors communication on the external bus between operator and e.g. PC. The response upon exceeding the adjusted time is defined with Pn.5. The time is adjustable in the range of 0 (no reaction); 0.01...10.00 s.

Response to E.buS (Pn.5) The possible reactions correspond to the reactions of Pn.3 (see above). Depending on the selected setting a status message E.buS or A.buS is output or fault is being ignored.

Level OL-warning (Pn.9) If the 100%-utilization of the inverter is exceeded by 5 %, the internal overload counter starts to count forward. If the utilization falls below 100 %, the counter counts backward. The current counter content can be read in parameter ru.39. Upon reaching 100 % the inverter switches off with error message „E.OL“ and the counter counts backward. When it has reached 0 % the status changes to E.nOL. The error can now be reset. With Pn.9 a level between 0...100 % can be adjusted, at which the condition OL-warning is fulfilled. The response to the warning signal is defined with Pn.8.

**Response to OL-warning
(Pn.8)**

Depending on the selected setting a status message E.OL or A.OL is output or the fault is being ignored.

Pn.8	Response	Description
0...5	see Pn.3	see Pn.3
6	warning signal only at dig. output	No effect on the drive. Error is being ignored. Switching condition do.0...7 Value „7“ is set.

**Limit switch error response
(Pn.7)
(only F5-M/S)**

This parameter adjusts the response if one of inputs programmed as limit switch is triggered. The possible reactions correspond to the reactions of Pn.3 (see left page). Depending on the selected setting and the rotation direction an error/status message E.Prr/A.Prr or E.PrF/A.PrF is output.

Level OH-warning (Pn.11)

The overtemperature detection protects the power module against overload. The temperature, at which the inverter switches off with error message „E.OH“ depends on the power circuit (usually 90°C). After a cooling phase the status changes from E.OH to E.nOH and can then be reset.

With Pn.11 a level between 0° C up to 90 °C is adjustable, at which the condition OH-warning is fulfilled. The response to the warning signal is defined with Pn.10.

**Response to OH-warning
(Pn.10)**

Pn.10	Response	Description
0...5	see Pn.3	see Pn.3
6	warning signal only at dig. output	No effect on the drive. Error is being ignored. Switching condition do.0...7 Value „8“ is set.

**Disconnecting time E.dOH
(Pn.13)**

The motor temperature detection protects the motor against thermal overload. A temperature sensor integrated into the motor winding is connected to the terminals T1/T2 of the inverter power circuit. Upon exceeding a resistance of 1650 Ohm (e.g. a motor temperature > Level Pn.62) the disconnecting time adjusted with Pn.13 is started, the switching condition dOH-warning is set and the adjusted response to the warning signal is carried out. After the expiration of the disconnecting time (Pn.13) the error E.dOH is triggered.

**Response to dOH-warning
(Pn.12)**

Depending on the selected setting a error / status message E.dOH or A.dOH is output and the selected response is activated. If overheat no longer exists, the message E.ndOH (or A.ndOH) is output. Only then the error can be reset or the automatic restart can be carried out.

Pn.12	Response	Description
0...5	see Pn.3	see Pn.3
6	warning signal only at dig. output	Switching condition Value „9“ is set.No effect on the drive until the disconnecting time (Pn.13).
7	warning signal disabled (default)	Function disabled; terminals are not queried. Switching condition Value „9“ is not set. Switching condition „46“ motor temperature is set.

Level dOH-warning (Pn.62)

A special power circuit is necessary for this function. The motor overtemperature level defines a temperature in the range of 0...200 °C. On exceeding the adjusted temperature the turn-off time (Pn.13) starts, the switching condition „46“ is set and the response according to Pn.12 is executed. After expiration of the turn-off time the inverter switches off with the error message E.dOH. The current temperature is indicated in ru.46.

At a standard power circuit the switching conditions „9“ and „46“ are set at Pn.12 = 0...6. At Pn.12 = 7 only the switching condition „46“ is set. In the motor temperature display ru.46 only T1-T2 closed or T1-T2 open is displayed.

Level OH2-warning (Pn.15)
(only for F5-S) An electronic motor protective circuit-breaker is integrated in servo F5-S (see Chapt. 6.7.8). A level of 0...100 % of the tripping time is adjustable with Pn.15. On reaching the adjusted level, the switching condition „OH2-warning“ is set (also see „Digital outputs“). The response to the warning signal is defined with Pn.14.

Response to OH2-warning (Pn.14) An electronic motor protective circuit-breaker is integrated in KEB COMBIVERT (see Chapt. 6.7.8). When the tripping times, defined according to VDE 0660, are exceeded the switching condition OH2-warning is set (also see „Digital outputs“).

Pn.14	Response	Description
0...5	see Pn.3	see Pn.3
6	warning signal only at dig. output	No effect on the drive. Error is being ignored. Switching condition do.0...7 Value „10“ is set.

OHI delay time (Pn.17) The interior temperature monitoring protects the inverter against malfunctions caused by too high temperature in the interior of the inverter. Upon exceeding a unit-specific temperature the interior fan is activated. If after approx. 10 minutes the temperature is still too high, the switch off time adjusted with Pn.17 is started, the switching condition „11“ OHI-warning is set and the adjusted response to the warning message is executed. After expiration of the switch-off time (0...120 s) the error E.OHI is triggered (also see „Digital Outputs“).

OHI stopping mode (Pn.16) The response to the warning signal is defined with Pn.16. Depending on the selected setting an error/status message E.OHI or A.OHI is output. After a cooling phase the inverter status changes from E.OHI to E.nOHI or in case of warning from A.OHI to A.nOHI and can then be reset.

Pn.16	Response	Description
0...5	as at Pn.3	as at Pn.3 The prewarning changes into an error. The drive remains in the error status until a reset signal is detected.
6	warning signal only at dig. output	No effect on the drive. Error is being ignored. Switching condition do.0...7 Value „11“ is set.
7	warning signal disabled	Function disabled; interior temperature is not evaluated.

E.Set stopping mode (Pn.18) This parameter determines the response to a set selection error. The possible reactions correspond to the reactions of Pn3. Depending on the selected setting an error/status message E.Set or A.Set is output.

Software limit switch error response (Pn.66) This parameter determines the response to a software limit switch error. The possible reactions correspond to the reactions of Pn3. Depending on the selected setting and the rotation direction an error/status message E.SLF/A.SLF or E.SLr/A.SLr is output.

6.7.7 Quick Stop (Pn.58...60)

The function Quick Stop is triggered through malfunctions (abnormal stopping) or by the control word (sy.50 Bit 8). It is defined by the following parameters.

Quick Stop / Mode (Pn.58)

The Quick Stop mode determines the basic operating mode of the function.

Pn.58	Description
Value	Control mode
0	Control via ramp generator (default)
1	Control via differential controller
Value	Actual value for differential controller
0	Apparent current (default)
2	Active current

Quick Stop / Level (Pn.59) (F5-G)

The Fast Stop level determines the setpoint value for the differential control. The adjustable value of 10...200% refers to a rated inverter current (In.1).

Quick Stop / Ramp time (Pn.60)

Depending on the adjustment of the control mode in Pn.58 the ramp time or the time constant of the differential controller is adjusted here within the range of 0...300.00 s (default 2.00 s). The ramp time refers to 100 Hz / 1000 rpm (depending on ud.2).

Quick Stop / Torque limit (Pn.61) (F5-M/S)

Setting of the torque limit during fast stop in the range of 0...10000 Nm.

Quick stop / max. torque at corner speed (Pn.67) (F5-M/S)

Setting of the max. torque at field weakening speed (dr.18) during quick stop in the range 0...10000,00 Nm (also see chap. 6.6.4).

Function description F5-G

Regulation by ramp generator

Quick stop with time delay stop (LD(U)-Stop) onto the minimum output value (op.36 / op.37). At abnormal stopping with holding torque the modulation remains switched on, otherwise it is switched off (also at quick stop by control word sy.50 Bit 8).

Regulation by differential controller

Quick stop with time delay stop (LD(U)-Stop) onto the minimum output value (op.36 / op.37) with variable step size (see below). At abnormal stopping with holding torque the modulation remains switched on, otherwise it is switched off.

The differential controller changes the adjusted step size (from pn.60), if the actual value is larger than the setpoint value:

$$\text{Adjusted step size} = \frac{100 \text{ Hz}}{\text{ramp time}}$$

$$\text{Step size} = \text{adjusted step size} * \left(1 + \frac{\text{Setpoint value} - \text{Actual value}}{\text{Inverter rated current}} \right)$$

Function description F5-M/S

At quick stop the motor is decelerated with the adjusted ramp time (pn.60) with LD(U)-Stop or at the torque limit (pn.61) to 0 rpm .

In case of abnormal stopping with holding torque the modulation remains active, otherwise it is switched off (also at quick stop via control word sy. 50 bit 8).

Used Parameters

Param.	Adr.	R/W	PROG.	ENTER	min	max	Step	default	
Pn.3	0403h	✓	-	-	0	6	1	0	-
Pn.4	0404h	✓	-	✓	0	4095	1	64	64 => I3
Pn.5	0405h	✓	-	-	0	6	1	6	-
Pn.6	0406h	✓	-	-	0: oFF	10,00 s	0,01 s	0: oFF	-
Pn.7	0407h	✓	-	-	0	6	1	6	-
Pn.8	0408h	✓	-	-	0	6	1	6	-
Pn.9	0409h	✓	-	-	0 %	100 %	1 %	80 %	-
Pn.10	040Ah	✓	-	-	0	6	1	6	-
Pn.11	040Bh	✓	-	-	0 °C	90 °C	1 °C	70 °C	-
Pn.12	040Ch	✓	-	-	0	7	1	6	-
Pn.13	040Dh	✓	-	-	0	120 s	1 s	10 s	-
Pn.14	040Eh	✓	-	-	0	6	1	6	-
Pn.15	040Fh	✓	-	-	0 %	100 %	1 %	100 %	only for F5-S
Pn.16	0410h	✓	-	-	0	7	1	7	-
Pn.17	0411h	✓	-	-	0 s	120 s	1 s	0 s	-
Pn.18	0412h	✓	-	-	0	6	1	0	-
Pn.58	043Ah	✓	-	✓	0	3	1	0	only for F5-G
Pn.59	043bh	✓	-	-	0 %	200 %	1 %	200 %	only for F5-G
Pn.60	043Ch	✓	-	-	0,00 s	300,00 s	0,01 s	2,00 s	-
Pn.61	043Dh	✓	-	-	0,00 Nm	10000,00 Nm	0,01 Nm	Adaption	-
Pn.62	043Eh	✓	-	-	0 °C	200 °C	1 °C	100 °C	-
Pn.66	0442h	✓	-	-	0	6	1	6	-

6.7.8 Motor Protection Mode

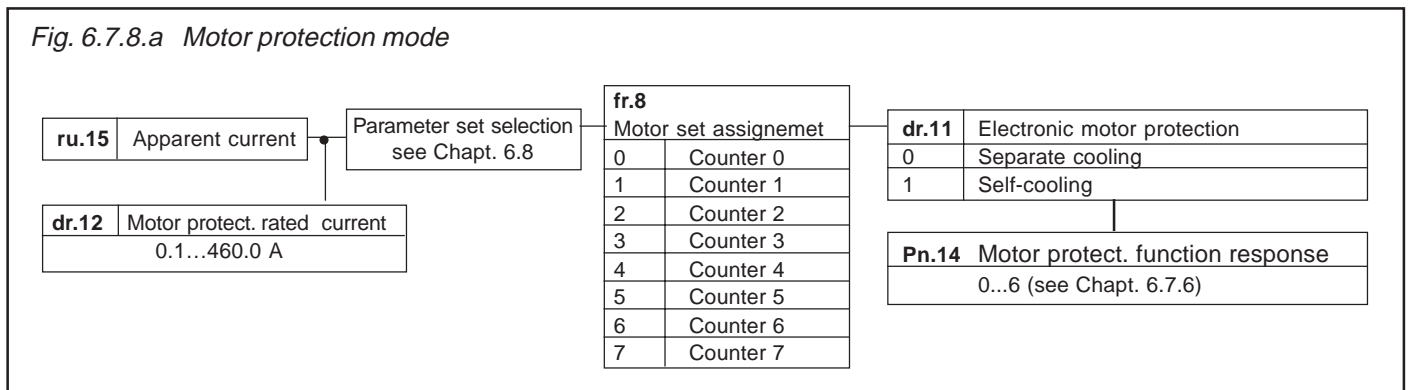
Description for F5-B, F5-G and F5-M

The motor protective function protects the connected motor against thermal destruction caused by high currents. The function corresponds largely to mechanical motor protective components, additionally the influence of the motor speed on the cooling of the motor is taken into consideration. The load of the motor is calculated from the measured apparent current (ru.15) and the adjusted rated motor current (dr.12).

For motors with separately driven fan or at rated frequency of a self-ventilated motor following tripping times (VDE 0660, Part 104) apply:

1,2	•	I_n	⇒	2 hours
1,5	•	I_n	⇒	2 minutes
2	•	I_n	⇒	1 minute
8	•	I_n	⇒	5 seconds

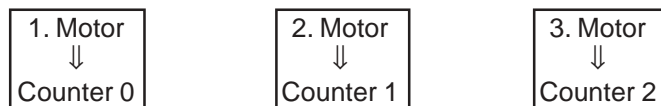
Fig. 6.7.8.a Motor protection mode



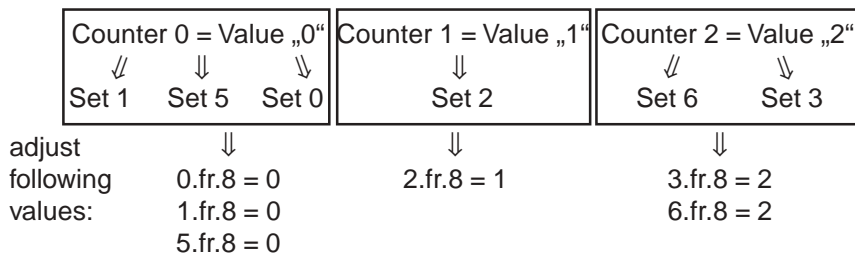
Motor set assignment fr.8

If several motors are operated on one inverter, each motor can be individually protected by selecting different counters (0...7).

Example: - a different counter is assigned to each motor



- this counter is now adjusted in all parameter sets of the corresponding motor



The counter works only in the active set with the measured value. In all inactive sets it is counted down. If one counter exceeds the limit, the response adjusted in Pn.14 is triggered.

Motor protection mode (dr.11) The cooling mode of the motor is adjusted with these programmable parameters.

Value	Function
0	Separate cooling (default)
1	Self-cooling

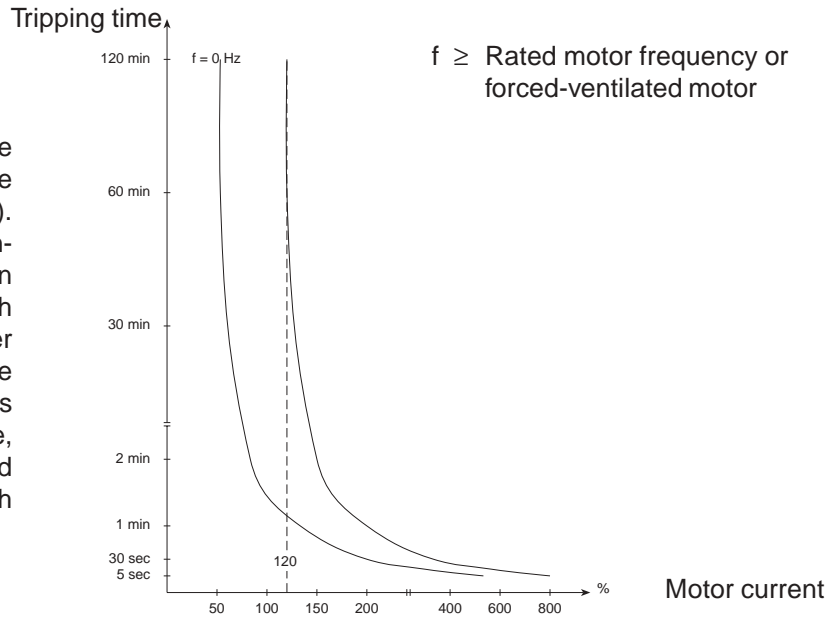
Motor protection / rated current (dr.12) This parameter specifies for each set the rated current (= 100% utilization) for the motor protective function. The motor protection-load is calculated as follows:

$$\text{Motor protection-load} = \frac{\text{Inverter Apparent current (ru.15)}}{\text{Motor protection rated current (dr.12)}}$$

OH2 stopping mode (Pn.14) This parameter determines the behaviour of the drive when the motor protective function responses. The function is described in Chapter 6.7.6.

Fig. 6.7.8.b Tripping times for F5-B, F5-G and F5-M

For self-ventilated motors the tripping times decrease with the frequency of the motor (see picture). The motor protective function acts integrating, i.e. times with overload on the motor are added, times with underload are subtracted. After triggering the motor protective function, the new tripping time is reduced to 1/4 of the specified value, if the motor has not been operated for an appropriate time with underload.

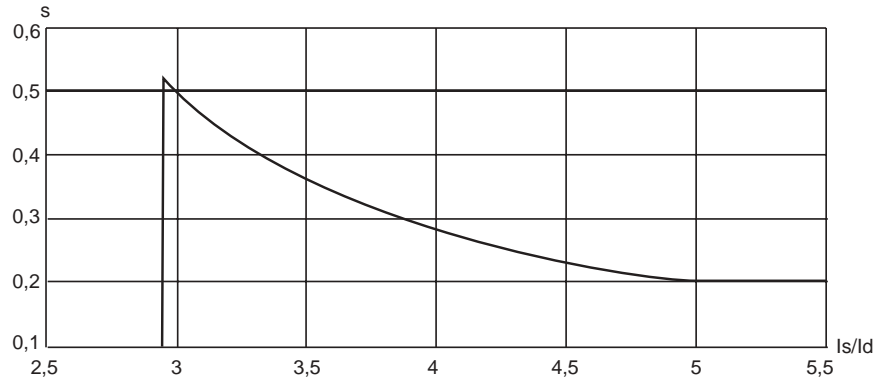


Description for F5-S

The internal overload counter counts downwards (100 % to 0 % in 5 s) with overload factors < 300 %. Above 300 % it is counted upwards according to following characteristic.

The tripping time is 200...500 ms; at overload factors above 500 % it is always 200 ms. If an error is triggered, it can be reset immediately. However, in this case the tripping time can be very short, since the counter decrements only slowly.

Bild 6.7.8.c Tripping time for F5-S



Formeln für den Überlastfaktor

$$\text{Overload factor} = \frac{\text{Inverter apparent current (ru.15)}}{\text{Rated current}}$$

$$\text{Continuous current} = \frac{(\text{Motor rated current (dr.23)} - \text{Standstill current (dr.28)}) \cdot \text{Real speed}}{\text{Motor rated speed (dr.24)}} + \text{Standstill current (dr.28)}$$

$$\text{Continuous current} = \text{Motor rated current (dr.23)}, \text{ if real speed} > \text{Motor rated speed (dr.24)}$$

Motorschutzfunktion Pegel (Pn.15)

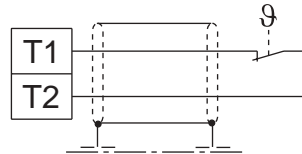
A level of 0...100 % of the tripping time is adjustable with Pn.15. On reaching the adjusted level, the switching condition „OH2-warning“ is set (also see „Digital outputs“). The response to the warning signal is defined with Pn.14.

Motorschutzfunktion Reaktion (Pn.14)

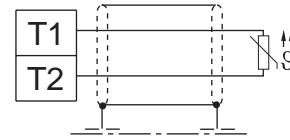
This parameter determines the behaviour of the drive if the motor protective function responds. The function is described in Chapter 6.7.6.

External error control procedure

The KEB COMBIVERT provides another possibility to protect the motor by connecting an external temperature monitoring. Following components can be connected to terminals T1/T2:



Thermo contact (NC contact)



Temperature sensor (PTC)
1650Ω...4kΩ tripping resistance
750Ω...1650Ω reset resistance

dOH stopping mode (Pn.12)
dOH delay time (Pn.13)

With these two parameters the behaviour of the terminals T1/T2 is determined. The function is described in Chapter 6.7.6.

Used Parameters

Param.	Adr.	R/W	PROG.	ENTER	min	max	Step	default	
fr.8	0908h	✓	✓	-	0	7	1	0	not at F5-S
Pn.12	040Ch	✓	-	-	0	7	1	7	-
Pn.13	040Dh	✓	-	-	0	120 s	1 s	0 s	-
Pn.14	040Eh	✓	-	-	0	6	1	6	-
Pn.15	040Fh	✓	-	-	0 %	100 %	1 %	100 %	only at F5-S
dr.11	060Bh	✓	✓	-	0	1	1	1	not at F5-S
dr.12	060Ch	✓	✓	-	0,0	710,0A	0,1A	LTK	not at F5-S
ru.15	020Fh	-	-	-	0,0	6553,5A	0,1A	-	-

6.7.9 GTR7-Control
(not at F5-B)

The GTR7 (brake transistor) serves for the control of the brake resistor. As a standard the GTR7 is switched in dependence on the DC-link voltage, in order to discharge fed-back energy. The switching behaviour of the GTR7 can be altered with the parameters Pn.64 and Pn.65. In the following some applications are specified, at which the factory setting should be modified.

Output filter Output filters, with the contained capacities and inductivities, form an oscillatory circuit with the motor, thus the drive also operates as generator.

Synchronous motors Synchronous motors operate as generator even if the modulation is switched off. .

Especially at low-load systems voltages can be induced, which can lead to the destruction of the inverter if no attention is paid to it.

Special functions (Pn.65 Bit 0) The energy fed into the intermediate circuit is transferred over the GTR7 to the brake resistor. However, as a standard the GTR7 only operates if the inverter modulates. Generally drives should always be decelerated in a controlled manner. With parameter Pn.65 the switching behaviour of the GTR7 can be adjusted as follows:

Pn.65	Switching behaviour GTR7
0	not in status „LS“ (default)
1	also switches at „LS“

Input selection GTR7 (Pn.64) With Pn.64 an input can be defined for the activation of the GTR7. In this case the GTR7 switches independent of the inverter status and the DC-link voltage as soon as the input is active. Exception: On opening the control release (noP) the inverter must switch off the GTR7 for safety reasons.

Bit -No.	Decimal value	Input	Terminal
0	1	ST (Prog. input „Control release/Reset“)	X2A.16
1	2	RST (Prog. input „Reset“)	X2A.17
2	4	F (Prog. input „Forward“)	X2A.14
3	8	R (Prog. Input „Reverse“)	X2A.15
4	16	I1 (Prog. Input 1)	X2A.10
5	32	I2 (Prog. Input 2)	X2A.11
6	64	I3 (Prog. input 3)	X2A.12
7	128	I4 (Prog. input 4)	X2A.13
8	256	IA (Internal input A)	none
9	512	IB (Internal input B)	none
10	1024	IC (Internal input C)	none
11	2048	ID (Internal input D)	none

Parallel connection of inverters (DC-interconnection) In a DC-interconnection of inverters the occurring braking energy can be distributed onto different inverters with brake resistor. With Pn.64 an input at the corresponding inverter can be defined over which the activation of the GTRs is synchronized.

Used Parameters

Param.	Adr.	RW	PROG.	ENTER	min	max	Step	default	
Pn.64	0440h	✓	-	-	0	4095	1	0	-
Pn.65	0441h	✓	-	-	0	7	1	0	-
©	KEB Antriebstechnik, 2002 All rights reserved		Name: Basis		Datum		Kapitel	Abschnitt	Seite
			KEB COMBIVERT F5		18.04.02		6	7	19

6.7.10 Special Functions

(not at F5-B)

Here functions are summarised which affect the behaviour of the inverter in certain operating cases.

Special Functions (Pn.65)

Bit	Value	Meaning
0		Switching behaviour GTR7 (see Chapter 6.7.9 „GTR-control“)
	0	GTR7 does not switch in the status „LS“ (default)
	1	GTR7 switches dependent on the level also at „LS“
1		This bit determines the error-/warning message, that is triggered at the switching of an external error input (Pn.4).
	0	Pn.4 is selection for external error-/warning message. The response to this message (A.EF/E.EF) is defined with Pn.3.
	1	Pn.4 is selection for error undervoltage (E.UP). Pn.3 has no function in this case.
2		Status, if the power circuit is not ready (no_PU). This setting applies to the output switching conditions do.0...7 = 4...6 and the ERROR-bit in the status word (sy.44/sy.51 Bit 1).
	0	State „no_PU“ is an Error
	1	State „no_PU“ is an Error

1. Introduction

2. Summary

3. Hardware

4. Operation

5. Parameter

6. Functions

7. Start-up

8. Special Operation

9. Error Assistance

10. Project Planning

11. Networks

12. Annex

6.1 Operating and Appliance Date

6.2 Analog In- and Outputs

6.3 Digital In- and Outputs

6.4 Set Value and Ramp Adjustment

6.5 Voltage-/Frequency Characteristic (U/f) Adjustment

6.6 Motor Data Adjustment

6.7 Protective Functions

6.8 Parameter Sets

6.9 Special Functions

6.10 Encoder Interface

6.11 SMM, Posi, Synchron

6.12 Technology Control

6.13 CP-Parameter Definition

6.8.1	Not programmable Parameters	3
6.8.2	Security-Parameters	3
6.8.3	System-Parameters	3
6.8.4	Indirect and Direct Set Addressing	3
6.8.5	Copying of Parameter Sets via Keyboard	4
6.8.6	Copying of Parameter Sets via Bus	4
6.8.7	Parameter Set Selection	5
6.8.8	Locking of Parameter Sets	8
6.8.9	Parameter Set ON and OFF Delay	8
6.8.10	Used Parameters	9

Chapter 6	Section 8	Page 2	Date 17.04.02	Name: Basis KEB COMBIVERT F5	© KEB Antriebstechnik, 2002 All rights reserved
---------------------	---------------------	------------------	------------------	--	--

6.8 Parameter Sets

The KEB COMBIVERT contains 8 parameter sets (0...7), i.e. all programmable parameters are available 8times in the inverter and independent of each other they can be assigned with different values. As a lot of parameters in the parameter sets contain the same value, it would be relatively complicated to change every parameter in each set individually. In this section it is described, how one copies whole parameter sets, locks them, selects them and reinitializes the inverter.

6.8.1 Not Programmable Parameters

Certain parameters are not programmable as their value must be the same in all sets (e.g. Bus address or Baud rate). In order to recognize these parameters immediately, the parameter identification is missing in the parameter set number. **The same value always applies to all not programmable parameters independent of the selected parameter set!**

6.8.1 Not programmable parameters

Sy-Parameter	uF.8/12-15/18 (uF.9 bei F5-S)
ru-Parameter	ud.1-17 (alle bei F5-S)
Ec-Parameter	Fr.2-4/7/9/11 (Fr.10 bei F5-S)
AA-Parameter	An.0-4/10-14/20-24/41-56
di-Parameter	LE.16-26
In-Parameter (Ausnahme: In.25)	cn.3/11-13
dr-Parameter (nicht bei F5-S)	dS.0-1 (nur F5-S)
oP.19/20/50/53-62	PS.2-4/10-27/29-31
Pn.0-18/23/27/29/44-60/62-66	

6.8.2 Security-Parameters

The Security parameters contain the Baud rate, inverter address, hours-meter, control type, serial-/customer number, trimming values and error diagnosis. They are not overwritten while copying parameter sets from the default set.

6.8.2 Security-Parameters

Sy.2/3/6/7/11
ru.40/41
ud.1/2
Fr.1
In.10-16/24-31

6.8.3 System-Parameters

The System parameters contain the motor and encoder data.

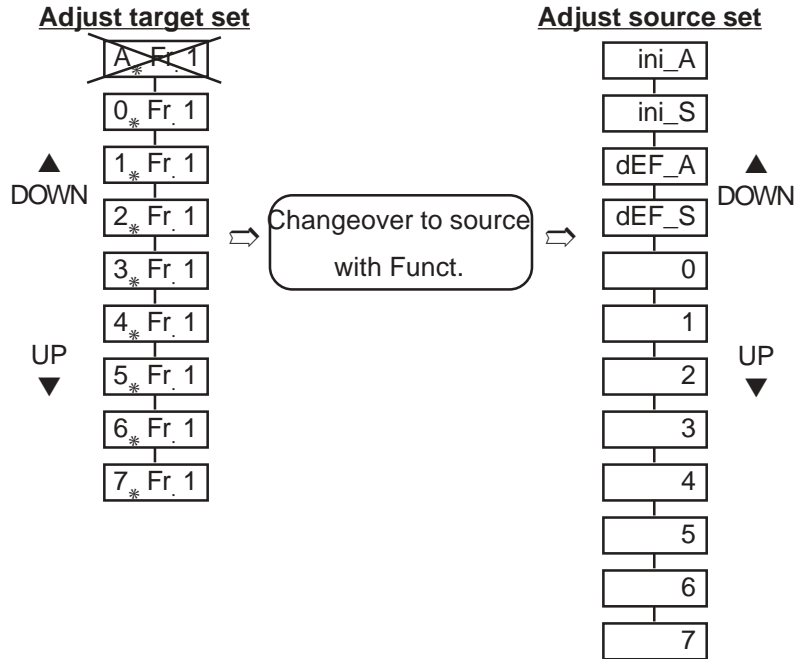
6.8.3 System-Parameters

dr-Parameter	Pn.61/67
cS.0-19-22	dS.0-1/13
Ec.1-7/11-27/36-38	Fr.10

6.8.4 Indirect and Direct Set Addressing

During indirect set addressing the parameter values are indicated and edited to the adjustment of the set indicator (Fr.9). The direct set addressing enables the display or writing of a parameter value independent of the set indicator directly into one or several parameter sets. The direct set programming is only possible with Bus operation.

6.8.5 Copying of Parameter Sets via Keyboard (Fr.1)



With the keys UP/DOWN and at flashing point the target set is adjusted in addition to the parameter set number. The active (A) parameter set must not be adjusted as target set while copying. If the target set is > 0, only the programmable parameters are overwritten!

The source set is adjusted with the keys UP/DOWN. The copying process is started with „Enter“. Copying is only possible with opened control release or error, otherwise „!_oPE“ appears in the display (invalid operation). After copying „PASS“ appears in the display and could be erase by „ENTER“.

6.8.6 Copying of Parameter Sets via Bus (Fr.1, Fr.9)

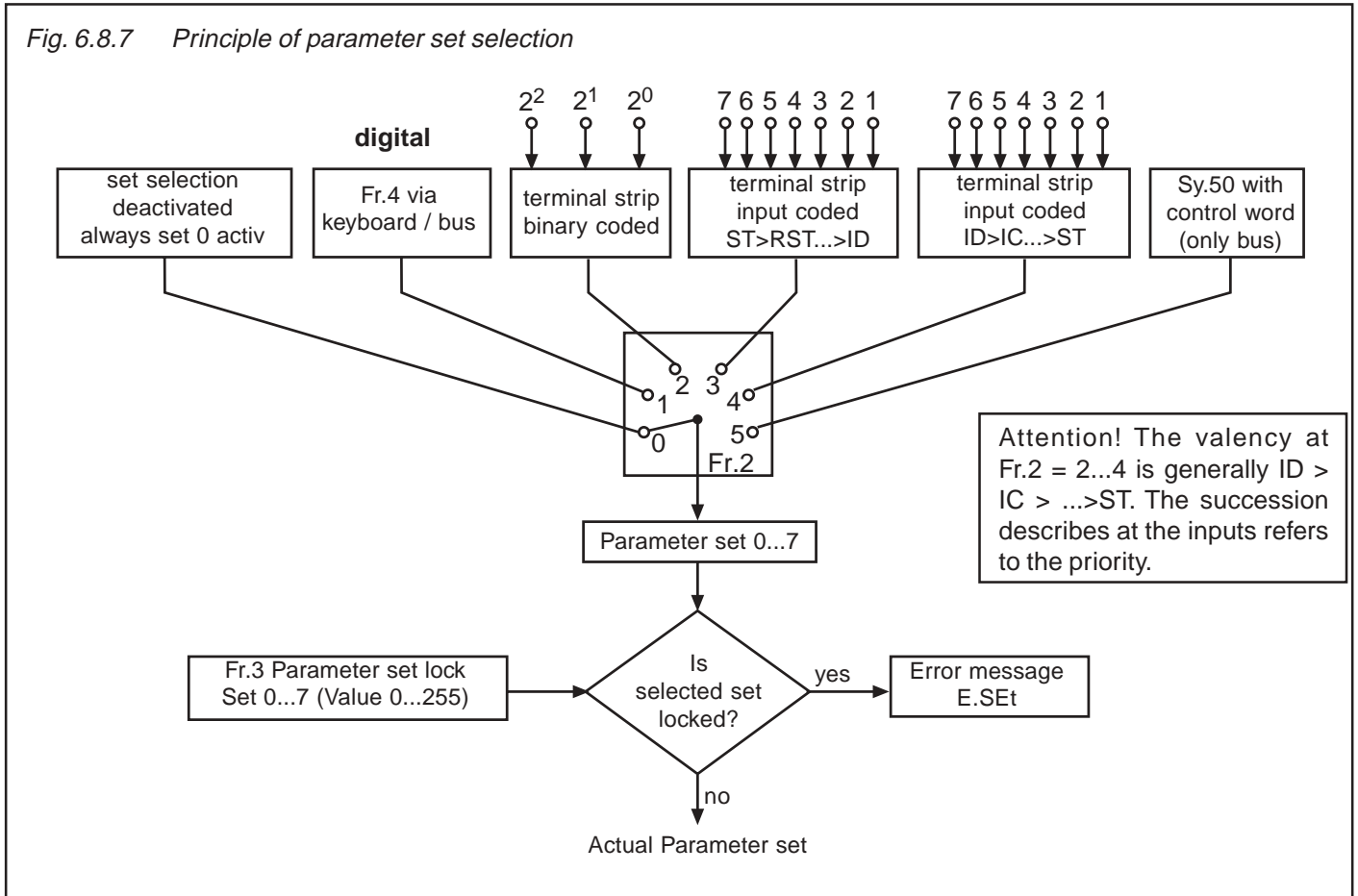
In the case of indirect set addressing at Bus operation two parameters are responsible for the copying of parameter sets. Fr.9 defines the target set. Fr.1 defines the source parameter set and starts the copying process. Parameter Fr.9 is not visible via keyboard. In the case of direct set programming the source set (Fr.1) is copied into the selected parameter sets. The following copying actions can be practised:

! By loading the factory setting all definitions defined by the mechanical engineer are reset! This can comprise the terminal assignment, set changeover or operating states. Before loading the default set it is to be ensured that no unintended operating states occur.

Target Set	Source Set	Action
0...7	0...7	All programmable parameters (System parameters too) of the source set are copied into the target set.
0	-1: dEF_S	Default values are copied into all parameters of set 0 (with the exception of System and Security parameters).
1...7	-1: dEF_S	Default values are copied into all programmable parameters of the target set (with the exception of System and Security parameters).
all	-2: dEF_A	Default values are copied into all parameters of all sets (with the exception of System and Security parameters).
0	-3: ini_S	Default values are copied into all parameters of set 0 (with the exception of Security parameters).
1...7	-3: ini_S	Default values are copied into all programmable parameters of the target set (with the exception of Security parameters).
all	-4: ini_A	Default values are copied into all parameters of all sets (with the exception of Security parameters).

6.8.7 Parameter Set Selection

Fig. 6.8.7 Principle of parameter set selection



Fr.2 Source parameter set As shown in Fig. 6.8.7, with Fr.2 it is defined whether the parameter set selection is enabled or disabled via keyboard/Bus (Fr.4), the terminal strip or via control word (SY.50). The selection is activated with „Enter“.

Fr.2	Function
0	Set selection deactivated; set 0 always active
1	Set selection via keyboard/Bus with Fr.4
2	Set selection binary-coded via terminal strip
3	Set selection input-coded via terminal strip Priority: ST>RST>R>F>I1>I2>I3>I4>IA>IB>IC>ID
4	Set selection input-coded via terminal strip Priority: ID>IC>IB>IA>I4>I3>I2>I1>R>F>RST>ST
5	Set selection via control word SY.50

Fr.4 Adjustment parameter set This parameter can be written by Bus as well as by keyboard. The desired parameter set (0...7) is preadjusted directly as value and activated with „Enter“.

Fr.7 Parameter set / Input selection The adjustment via terminal strip can be made binary-coded or input-coded. The inputs are defined with parameter Fr.7.

Bit -No.	Decimal value	Input	Terminal
0	1 ¹⁾	ST (Prog. input „Control release/Reset“)	X2A.16
1	2	RST (Prog. input „Reset“)	X2A.17
2	4	F (Prog. input „Vorwärts“)	X2A.14
3	8	R (Prog. input „Rückwärts“)	X2A.15
4	16	I1 (Prog. input 1)	X2A.10
5	32	I2 (Prog. input 2)	X2A.11
6	64	I3 (Prog. input 3)	X2A.12
7	128	I4 (Prog. input 4)	X2A.13
8	256	IA (Internal input A)	none
9	512	IB (Internal input B)	none
10	1024	IC (Internal input C)	none
11	2048	ID (Internal input D)	none

¹⁾ The input ST is occupied by hardware means with the function „Control release“. Further functions can be adjusted only „additionally“.

Example For input-coded set selection (Fr.2=3) I1, I2 and F are defined for set selection. In this case F = set1; I1 = set2 and I2 = set3 would be acticated as the valence is (I2>I1>F). If I1 and I2 are triggered simuleatously the inverter switches into set2 since the priority is F>I1>I2 at Fr.2.

Binary-coded set selection With binary-coded set selection

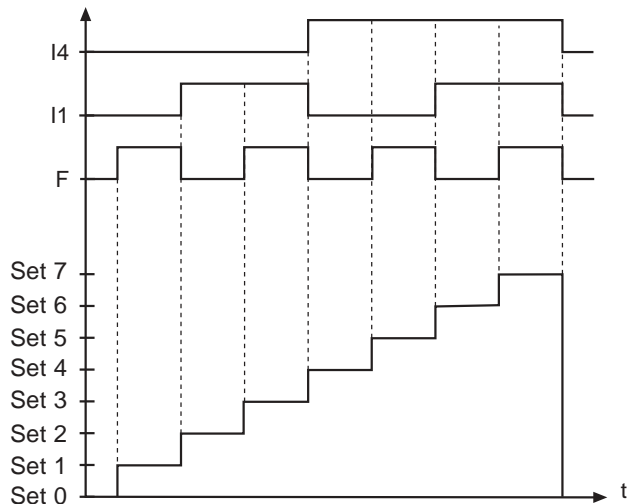
- maximally 3 of the internal or external inputs may be programmed to set selection ($2^3=8$ sets) to avoid set selection errors.
- the valence of the inputs programmed for set selection rises (ID>IC>IB>IA>I4>I3>I2>I1>R>F>RST>ST)

Example 1: With 3 inputs (F, I1 and I4) set 0...7 shall be selected

- 1.) Adjust parameter Fr. 7 to value „148“
- 2.) Adjust Fr.2 to value „2“ (set selection binary-coded via terminal strip)

Fig. 6.8.7.b Binary-coded parameter set selection

I4	I1	F	Input Set
2 ²	2 ¹	2 ⁰	
0	0	0	0
0	0	1	1
0	2	0	2
0	2	1	3
4	0	0	4
4	0	1	5
4	2	0	6
4	2	1	7



Input-coded set selection

With input-coded set selection

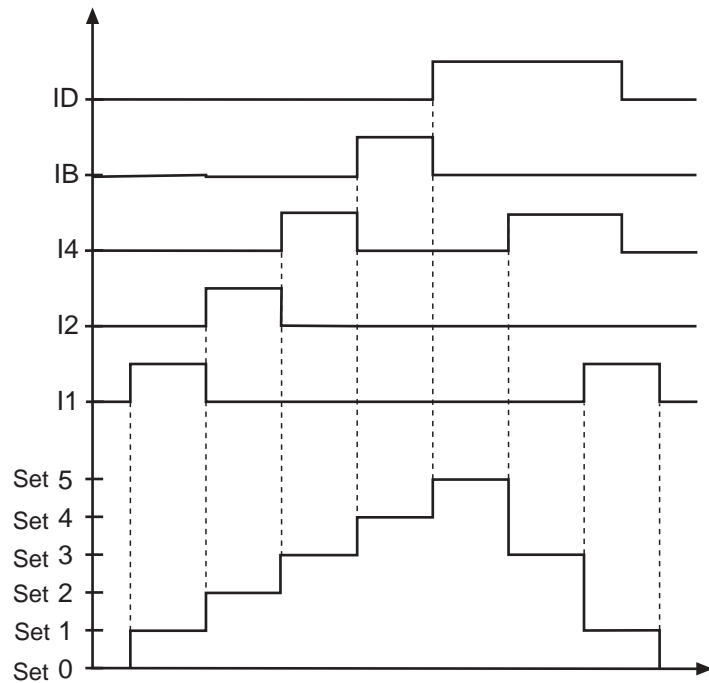
- maximally 7 of the internal or external inputs may be programmed to set selection (0...7 sets) to avoid set selection errors.
- the lowest of the selected inputs has priority at Fr.2 = „3“ (ST>RST>R>F>I1>I2>I3>I4>IA>IB>IC>ID)
- the highest of the selected inputs has priority at Fr.2 = „4“ (ID>IC>IB>IA>I4>I3>I2>I1>R>F>RST>ST)

Example1: With 5 inputs (I1, I2, I4, IB and ID) set 0...5 shall be selected.

- 1.) Adjust parameter Fr. 7 to value „2736“
- 2.) Adjust Fr.2 to value „3“ (set selection input-coded via terminal strip)

Fig. 6.8.7.c Input-coded parameter set selection (Fr.2=3)

ID	IB	I4	I2	I1	Set	Set
					Fr.2 =	3
						4
0	0	0	0	0	0	0
0	0	0	0	1	1	1
0	0	0	2	0	2	2
0	0	3	0	0	3	3
0	4	0	0	0	4	4
5	0	0	0	0	5	5
5	0	3	0	0	3	5
5	0	3	0	1	1	5



Reset set input selection (Fr.11)

This parameter defines an input, with which one can switch independently of the current parameter set in to parameter set 0 (see table at Fr.7). This function is only activ at Fr.2 = 0...4.

- with static input assignment the inverter remains in set 0 as long as the input is set.
- with edge-triggered inputs set 0 is always activated with the 1st edge. With the 2nd edge the set activated by the other inputs is selected again.

6.8.8 Locking of Parameter Sets

Parameter set, that shall not and must not be selected, can be locked with Fr.3. If one of the locked sets is selected, the inverter switches off with set selection error (E.SET).

Fr.3 Parameter set lock

Value	Locked set	Example
1	0	-
2	1	-
4	2	4
8	3	-
16	4	-
32	5	32
64	6	-
128	7	-
Set 2 and Set 5 locked		Sum 36

6.8.9 Parameter Set ON/Off Delay (Fr.5, Fr.6)

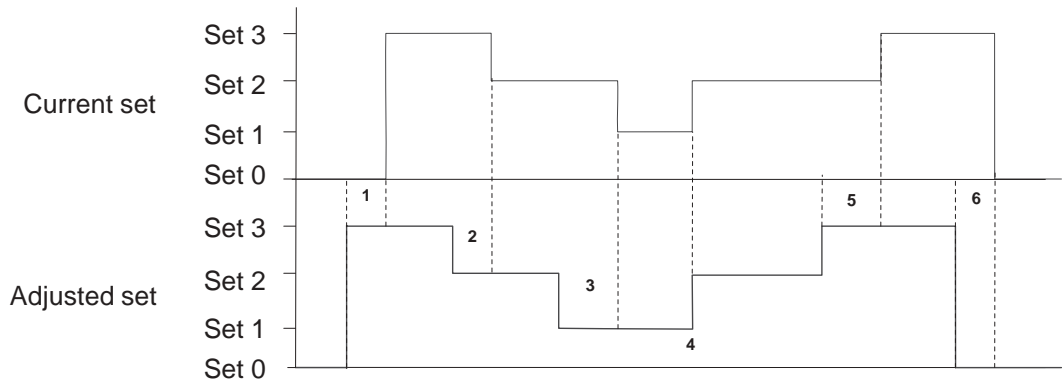
With these parameters the time is adjusted,

- with which the activation of a new set is delayed (Fr.5)
- with which the deactivation of an old set is delayed (Fr.6)

In the case of set changeover the OFF time of the old set and ON time of the new set are added up.




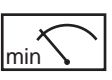
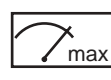

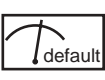

Fig. 6.8.9 ON and OFF-delay

Example		
	on	off
Set	Fr.5	Fr.6
0	0 s	0 s
1	2 s	0 s
2	0 s	1 s
3	2 s	2 s



- 1: ON delay for set 3 of 2s
- 2: OFF delay for set 3 of 2s
- 3: OFF delay for set 2 of 1s + ON delay for set 1 of 2 s
- 4: immediate changeover as no delay is adjusted
- 5: OFF delay for set 2 of 1s + ON delay for set 3 of 2s
- 6: OFF delay for set 3 of 2s

6.8.10 Used Parameters

Param.	Adr.								
Fr.1	0901h	✓	✓	✓	-4	7	1	0	-
Fr.2	0902h	✓	-	✓	0	5	1	0	-
Fr.3	0903h	✓	-	✓	0	255	1	0	-
Fr.4	0904h	✓	-	✓	0	7	1	0	-
Fr.5	0905h	✓	✓	-	0	2.55 s	0.01 s	0	-
Fr.6	0906h	✓	✓	-	0	2.55 s	0.01 s	0	-
Fr.7	0907h	✓	-	✓	0	4095	1	0	-
Fr.9	0909h	✓	-	-	-1	7	1	0	-1: activ set (only via bus)
Fr.11	090Bh	✓	✓	✓	0	4095	1	0	-

Chapter	Section	Page	Date	Name: Basis	©	KEB Antriebstechnik, 2002 All rights reserved
6	8	10	17.04.02	KEB COMBIVERT F5		

1. Introduction

2. Summary

3. Hardware

4. Operation

5. Parameter

6. Functions

7. Start-up

8. Special Operation

9. Error Assistance

10. Project Planning

11. Networks

12. Annex

6.1 Operating and Appliance Date

6.2 Analog In- and Outputs

6.3 Digital In- and Outputs

6.4 Set Value and Ramp Adjustment

6.5 Voltage-/Frequency Characteristic (U/f) Adjustment

6.6 Motor Data Adjustment

6.7 Protective Functions

6.8 Parameter Sets

6.9 Special Functions

6.10 Encoder Interface

6.11 SMM, Posi, Synchron

6.12 Technology Control

6.13 CP-Parameter Definition

6.9.1	DC-Braking.....	3
6.9.2	Energy Saving Function	5
6.9.3	Motor Potentiometer	7
6.9.4	Timer and Counter	11
6.9.5	Brake Control	15
6.9.6	Power-Off Function	19
6.9.7	Wobbel Function	27
6.9.8	Diameter Correction	29
6.9.9	Positioning Function	31
6.9.10	Analog setting of parameter values	34

6.9 Special Functions

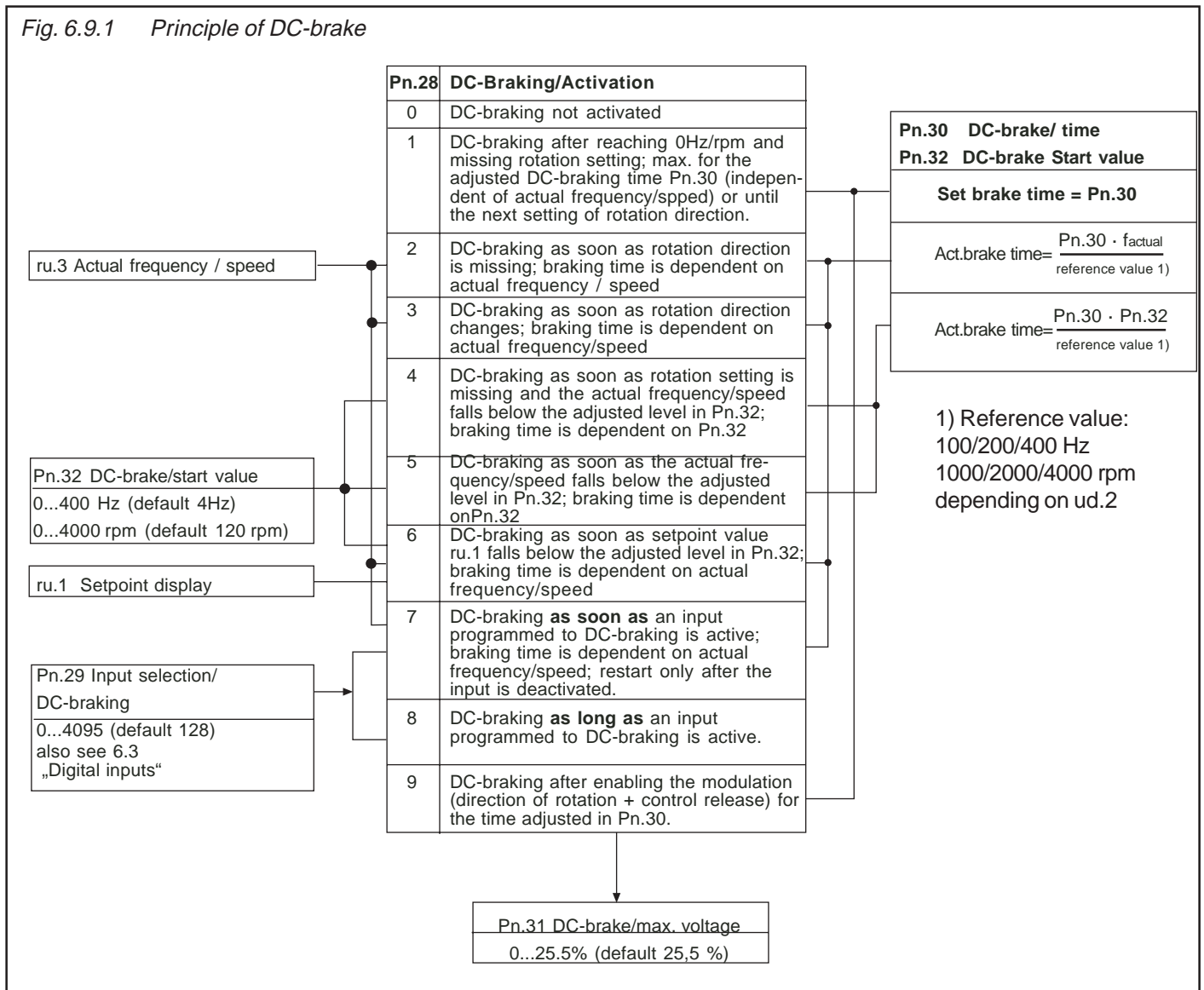
6.9.1 DC-Braking

(only F5-B, F5-G and F5-M if cS.0=0)

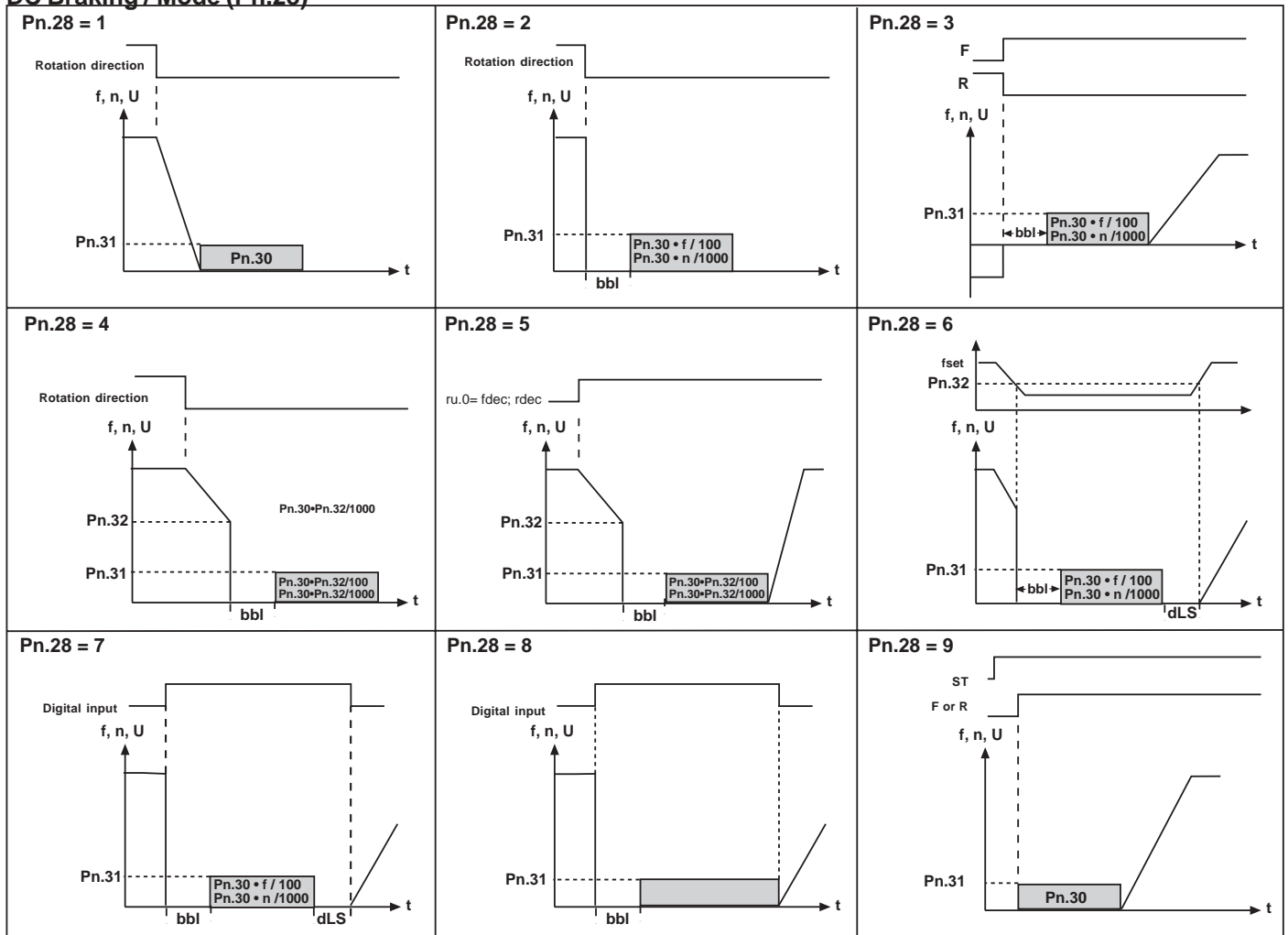
The following section should facilitate the adjustment and programming of special functions.

During the DC-braking the motor is not decelerated over the ramp. The fast deceleration is done with DC-voltage, that is given onto the motor winding. Between the activation and the triggering of DC-braking a time constant called Base-Block time (bbl) of 150...5000 ms (depending on the power circuit) is necessary. It serves as protection of the power modules during the motor de-excitation time. With Pn.28 one adjusts through what the DC-brake is triggered. According to the adjusted mode one can preset with Pn.32 the frequency/speed from which the DC-brake is triggered. Pn.30 defines the braking time. The maximum braking voltage is adjusted with Pn.31. The brake controllers are dimensioned 1:1 of inverter to motor, thus the maximum braking voltage must be reduced in the case of deviating dimensioning to prevent the overheating of the motor. At large ratings the maximum braking voltage can lead to overcurrent errors (OC). In that case reduce it with Pn31. Pn.29 is bit-coded and defines the inputs which trigger DC-braking.

Fig. 6.9.1 Principle of DC-brake



DC Braking / Mode (Pn.28)



Input selection
DC-braking (Pn.29)

Bit-No.	Decimal value	Input	Terminal
0	1	ST (Prog. input „Control release/Reset“)	X2A.16
1	2	RST (Prog. input „Reset“)	X2A.17
2	4	F (Prog. input „Forward“)	X2A.14
3	8	R (Prog. input „Reverse“)	X2A.15
4	16	I1 (Prog. input 1)	X2A.10
5	32	I2 (Prog. input 2)	X2A.11
6	64	I3 (Prog. input 3)	X2A.12
7	128	I4 (Prog. input 4)	X2A.13
8	256	IA (Internal input A)	none
9	512	IB (Internal input B)	none
10	1024	IC (Internal input C)	none
11	2048	ID (Internal input D)	none

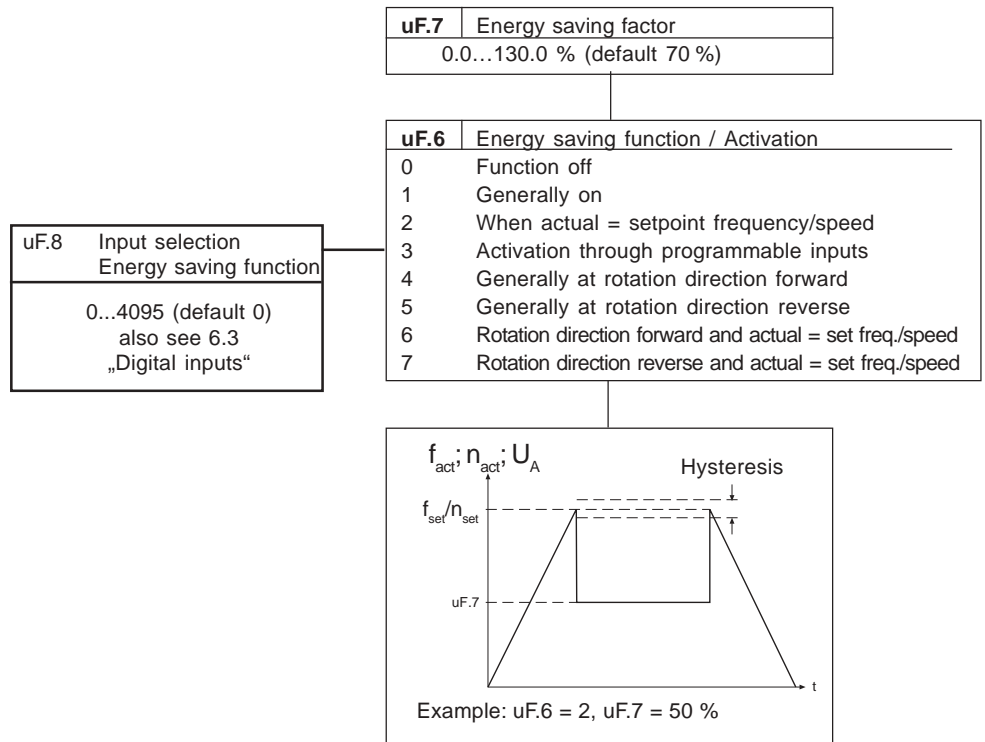
Used Parameters

Param.	Adr.	R/W	PROG.	ENTER	min	max	Step	default	
Pn.28	041Ch	✓	✓	✓	0	9	1	7	-
Pn.29	041Dh	✓	-	✓	0	4095	1	64	-
Pn.30	041Eh	✓	✓	-	0.00	100.00 s	0.01 s	10.00 s	-
Pn.31	041Fh	✓	✓	-	0	25.5 %	0.1 %	25.5 %	-
Pn.32	0420h	✓	✓	-	0	400 Hz	0,0125 Hz	4 Hz	F5-G/B depending on ud.2
Pn.32	0420h	✓	✓	-	0	4000 rpm	0,125 rpm	120 rpm	F5-M depending on ud.2

6.9.2 Energy Saving Function

(only F5-B, F5-G and F5-M if cS.0=0)

The energy saving function allows the lowering or raising of the current output voltage. In accordance with the activation conditions defined in uF.6, the voltage valid according to the V/Hz-characteristic is changed in percent onto the energy saving level (uF.7). However, the maximal output voltage cannot be higher than the input voltage even if the value is > 100 %. The function is used for example in cyclic executed load/no-load applications. During the no-load phase the speed is maintained, but energy is saved as a result of the voltage reduction.



Used Parameters

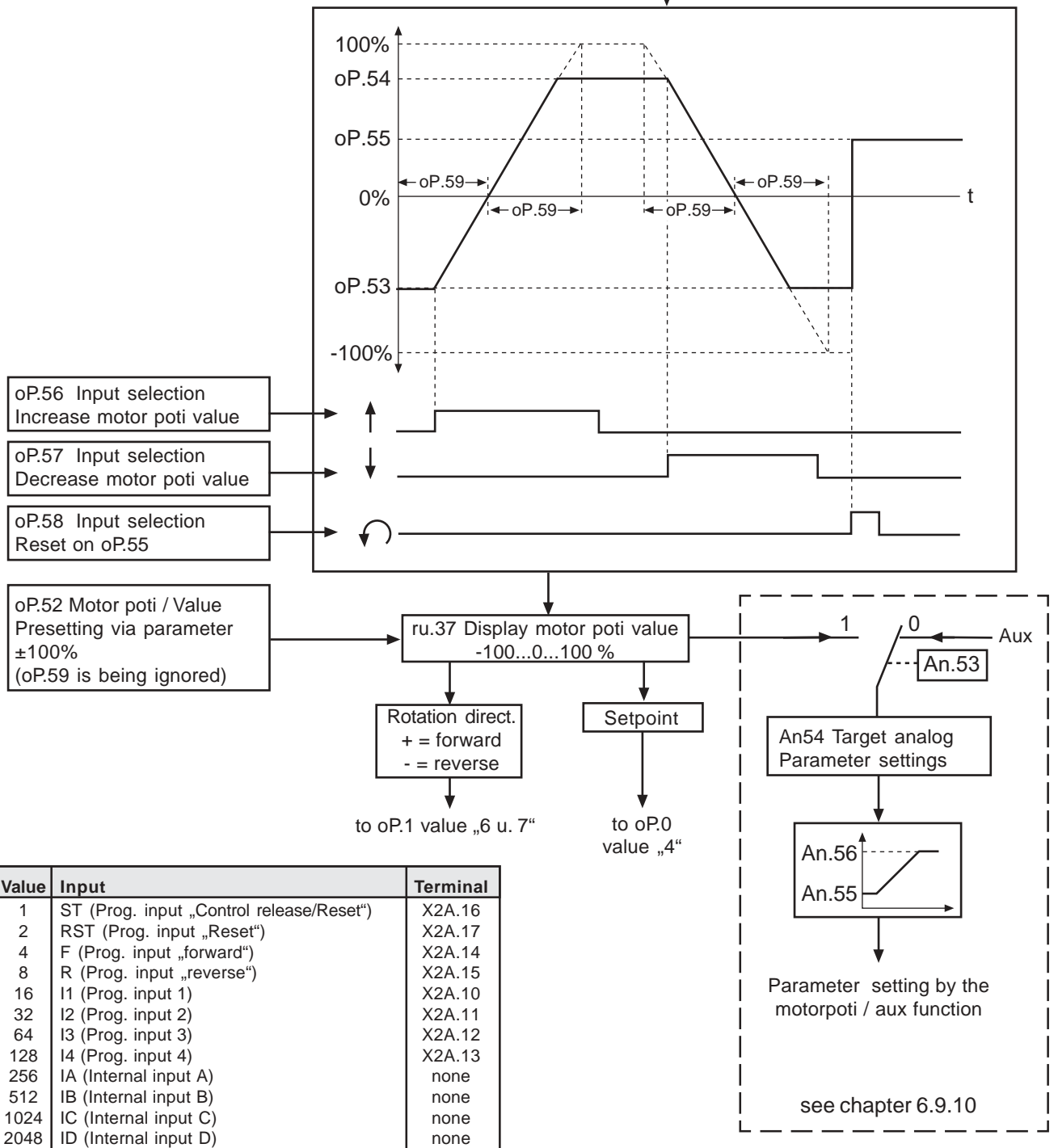
Param.	Adr.	R/W	PROG.	ENTER	min	max	Step	default	
uF.6	0506h	✓	✓	-	0	7	1	0	-
uF.7	0507h	✓	✓	-	0.0 %	130.0 %	1 %	70 %	-
uF.8	0508h	✓	-	✓	0	4095	1	128	-

6.9.3 Motor Potentiometer Function

This function simulates a mechanic motor potentiometer. Over two inputs the motor potentiometer value can be increased or decreased.

Fig. 6.9.3 Motor potentiometer function

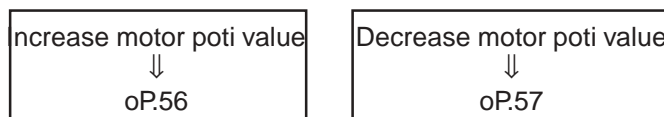
oP.50 Motor potentiometer / Function		
Bit0	Bit1	Meaning
x	0	Set-programmable
x	1	Not set-programmable
0	x	No motor poti reset after Power-on
1	x	Reset on oP.55 after Power-on



Bit	Value	Input	Terminal
0	1	ST (Prog. input „Control release/Reset“)	X2A.16
1	2	RST (Prog. input „Reset“)	X2A.17
2	4	F (Prog. input „forward“)	X2A.14
3	8	R (Prog. input „reverse“)	X2A.15
4	16	I1 (Prog. input 1)	X2A.10
5	32	I2 (Prog. input 2)	X2A.11
6	64	I3 (Prog. input 3)	X2A.12
7	128	I4 (Prog. input 4)	X2A.13
8	256	IA (Internal input A)	none
9	512	IB (Internal input B)	none
10	1024	IC (Internal input C)	none
11	2048	ID (Internal input D)	none

see chapter 6.9.10

Determine inputs (oP.56...oP58) In the first step 2 inputs must be defined with which the motor potentiometer can be increased or decreased. For that purpose one input each according to the input table is assigned to the parameters oP.56 and oP.57. If both inputs are triggered simultaneously, the potentiometer values is decreased.



Another input (oP.58) can be used to reset the motor potentiometer to the adjusted reset value oP.55.

Input table

Bit -No.	Decimal value	Input	Terminal
0	1	I7/ST (Control release)	X2A.16
1	2	I8 Prog. input	X2A.17
2	4	I5 Prog. input	X2A.14
3	8	I6 Prog. input	X2A.15
4	16	I1 Prog. input	X2A.10
5	32	I2 Prog. input	X2A.11
6	64	I3 Prog. input	X2A.12
7	128	I4 Prog. input	X2A.13
8	256	IA (Internal input A)	none
9	512	IB (Internal input B)	none
10	1024	IC (Internal input C)	none
11	2048	ID (Internal input D)	none

Motor potentiometer/Function (oP.50) The basic working method of the motor potentiometer is defined with oP.50. The parameter is bit-coded.

Bit	oP.50 Motor potentiometer / Function
1 0	
x 0	Motor poti is changed in the current set (default)
x 1	Motor poti is changed only in set 0
0 x	Motor poti value is maintained after Power-on (default)
1 x	Motor poti value is reset to reset value oP.55 after Power-on

Motor potentiometer/Rise time (oP.59) With this parameter a time is defined, which the motor potentiometer needs in order to run from 0...100 %. The time is adjustable between 0...50000 s.

The correcting range (oP.53, oP.54) The correcting range is limited by the parameters oP.53 and oP.54 (see Fig. 6.9.3.).

Display of motor potentiometer value (ru.37) This parameter shows the current value of the motor potentiometer in percent.

Motor potentiometer value (oP.52) With this parameter a value in percent can be adjusted within the preset limits directly by operator or bus. The ramp time (oP.59) remains unconsidered at this setting.

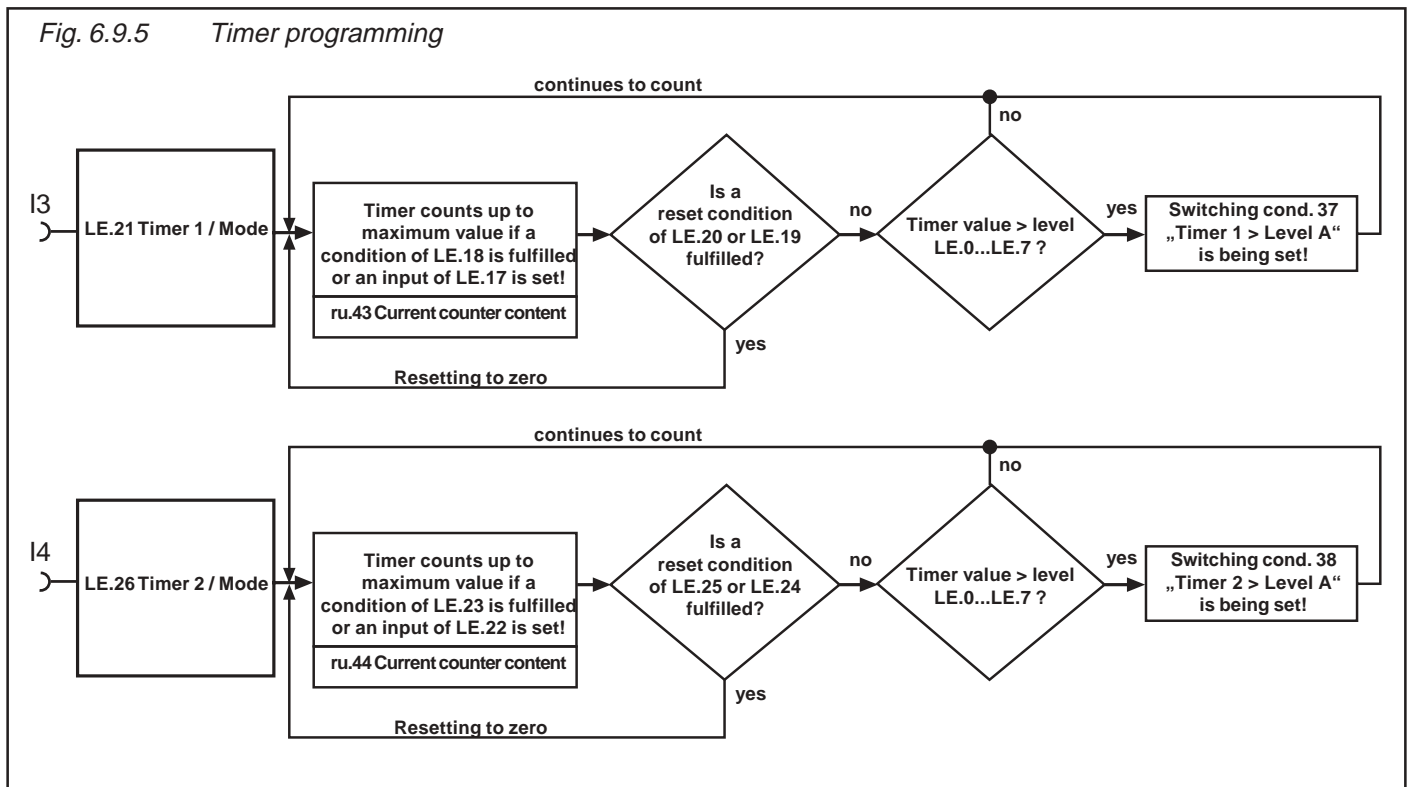
Source of Setpoint (oP.0) and Direction of rotation (oP.1) In order to preset the setpoint by way of the motor potentiometer, oP.0 (setpoint source) must be set to value „4“. The source of rotation direction (oP.1) must be adjusted in dependence on the setpoint (value „6“ or „7“).
If the motor potentiometer is used as setpoint source, the setpoint is calculated from this with the respective limits just as with other percental setpoint sources (see Chapter 6.4. „Set Value Adjustment“).

Used Parameters

Param.	Adr.	RW	PROG	ENTER	min	max	Step	default	
ru.37	0225h	-	-	-	-100.00 %	100.00 %	0.01 %	-	-
oP.0	0300h	✓	✓	✓	0	9	1	0	„4“ for motor potentiometer
oP.1	0301h	✓	✓	✓	0	9	1	2	„6 and 7“ rotation direct. over setpoint
oP.50	0332h	✓	-	✓	0	3	1	0	-
oP.52	0334h	✓	✓	-	-100,00 %	100,00 %	0,01 %	0,00 %	-
oP.53	0335h	✓	-	-	-100,00 %	100,00 %	0,01 %	0,00 %	-
oP.54	0336h	✓	-	-	-100,00 %	100,00 %	0,01 %	100,00 %	-
oP.55	0337h	✓	-	-	-100,00 %	100,00 %	0,01 %	0,00 %	-
oP.56	0338h	✓	-	✓	0	4095	1	0	-
oP.57	0339h	✓	-	✓	0	4095	1	0	-
oP.58	033Ah	✓	-	✓	0	4095	1	0	-
oP.59	033Bh	✓	-	-	0,00 s	50000,00 s	0,01 s	66,00 s	-

6.9.4 Timer and Counter

Two timers are incorporated in the COMBIVERT. As long as one of the adjustable starting conditions (LE.18/23) or a programmable input (LE.17/22) is set, the timer counts until reaching the final range value. If one of the reset conditions (LE.20/25) is fulfilled or one programmable input (LE.19/24) is set, the timer jumps back to zero. The resolution, whether the timer works in seconds or hours, is adjusted with LE.21/26. The current timer content is displayed in ru.43/44. On reaching an adjustable comparison level (LE.0...7), the switching condition 37/38 is set. It can be used to set an output.



Timer / Mode (LE.21/26) LE.21 and LE.26 determine the clock source and the counting direction of timer 1 and timer 2. Clock source can be the time counter in 0.01 s or h-raster or impulses from an input. The timer runs generally as long as a starting condition is active. After a reset the timer starts again at zero. The timer stops at the maximal value of 655.35. Following clock sources can be selected:

Bit	Value	Function
0...2		Clock source
	0	Time counter 0,01 s (default)
	1	Time counter 0,01 hour
	2	Edge counter, each edge increases/decreases the counter by 0.01
3		Edge counter, only positive edges increase/decrease the counter by 0.01
	4...7	reserviert
3...5		Counting direction
	0	Upward
	8	The counting direction is dependent on direction of rotation (FOR=upward; REV=downward)
16		The counting direction is dependent on direction of rotation (REV=upward; FOR=downward)

The values from Bit 0...2 and 3...5 are to be added up.

Timer / Starting condition (LE.18/23) From the following table the conditions can be selected at which the timer is started. The individual conditions are OR-operated.

Bit	Value	Timer / Starting condition
0	1	Modulation on
1	2	Modulation off
2	4	Actual freq. =setpoint freq.

In case of several starting conditions the values are to be added up.

Timer start Input selection (LE.17/22) Additionally the timer can be activated by one or several inputs. The sum of the valences is to be entered, if the timer shall be started by different inputs. The individual inputs are OR-operated.

Bit -No.	Decimal value	Input	Terminal
0	1	ST (prog. input „control release/Reset“)	X2A.16
1	2	RST (prog. input „Reset“)	X2A.17
2	4	F (prog. input „forward“)	X2A.14
3	8	R (prog. input „reverse“)	X2A.15
4	16	I1 (prog. input 1)	X2A.10
5	32	I2 (prog. input 2)	X2A.11
6	64	I3 (prog. input 3)	X2A.12
7	128	I4 (prog. input 4)	X2A.13
8	256	IA (internal input A)	none
9	512	IB (internal input B)	none
10	1024	IC (internal input C)	none
11	2048	ID (internal input D)	none

Current counter content (ru.43/44) ru.43 / ru.44 displays the actual counter reading dependend of the adjusted clock source (LE.21/26). By writing on ru.43/44 the counter can be set to a value. If the clock source is changed during the running time the counter content is maintained but is interpreted according to the new clock source.

Input selection / Timer Reset (LE.19/24) According to following table the inputs with which the timer is reset can be specified. The individual inputs are OR-operated, i.e. if one of the specified inputs is triggered, the timer jumps back to zero. If a starting and reset condition are active simultaneously, reset has priority.

Bit -No.	Decimal value	Input	Terminal
0	1	ST (prog. input „control release/Reset“)	X2A.16
1	2	RST (prog. input „Reset“)	X2A.17
2	4	F (prog. input „forward“)	X2A.14
3	8	R (prog. input „reverse“)	X2A.15
4	16	I1 (prog. input 1)	X2A.10
5	32	I2 (prog. input 2)	X2A.11
6	64	I3 (prog. input 3)	X2A.12
7	128	I4 (prog. input 4)	X2A.13
8	256	IA (internal input A)	none
9	512	IB (internal input B)	none
10	1024	IC (internal input C)	none
11	2048	ID (internal input D)	none

Timer Reset condition (LE.20/25) According to following table the conditions can be defined under which the timer is reset in addition to the inputs. The individual conditions are OR-operated.

Bit -No.	Decimal value	Condition
0	1	Modulation on
1	2	Modulation off
2	4	Setpoint frequency = Actual frequency
3	8	Change of parameter set
4	16	Power-On-Reset

Comparison level 0...7 (LE.0...LE.7) LE.0...LE.7 define the level for the switching conditions 37/38 („timer > level“). If the timer exceeds the adjusted value the switching condition is set. A level in the range of -10.737.418,24 bis 10.737.418,23 can be adjusted. But only values of 0...655,34 are sensible for the counter.

Used Parameters

Param.	Adr.	RW	PROG.	ENTER	min	max	Step	default	
ru.43	022Bh	✓	-	-	0,00	655,35	0,01	0,00	-
ru.44	022Ch	✓	-	-	0,00	655,35	0,01	0,00	-
LE.0	0D00h	✓	✓	-	-10737418,24	10737418,23	0,01	0	-
LE.1	0D01h	✓	✓	-	-10737418,24	10737418,23	0,01	0	-
LE.2	0D02h	✓	✓	-	-10737418,24	10737418,23	0,01	0	-
LE.3	0D03h	✓	✓	-	-10737418,24	10737418,23	0,01	0	-
LE.4	0D04h	✓	✓	-	-10737418,24	10737418,23	0,01	0	-
LE.5	0D05h	✓	✓	-	-10737418,24	10737418,23	0,01	0	-
LE.6	0D06h	✓	✓	-	-10737418,24	10737418,23	0,01	0	-
LE.7	0D07h	✓	✓	-	-10737418,24	10737418,23	0,01	0	-
LE.17	0D11h	✓	-	✓	0	4095	1	0	bitcoded
LE.18	0D12h	✓	-	✓	0	7	1	0	-
LE.19	0D13h	✓	-	✓	0	4095	1	0	bitcoded
LE.20	0D14h	✓	-	✓	0	31	1	16	-
LE.21	0D15h	✓	-	-	0	31	1	0	-
LE.22	0D16h	✓	-	✓	0	4095	1	0	bitcoded
LE.23	0D17h	✓	-	✓	0	7	1	0	-
LE.24	0D18h	✓	-	✓	0	4095	1	0	bitcoded
LE.25	0D19h	✓	-	✓	0	31	1	16	-
LE.26	0D1Ah	✓	-	-	0	31	1	0	-

6.9.5 Brake Control

For applications in the field of lifting and lowering the control of the holding brake can be taken over by this function. A digital output can be programmed as control signal. The function is set-programmable.

Mode of functioning

As shown in the opposite graphic a torque in the amount of the power difference $F1-F2$ must be built up, so that F1 does not slump after releasing the brake. We call that holding torque. In the case of the slip-affected three-phase asynchronous machine a frequency in the direction of the holding torque must be preset.

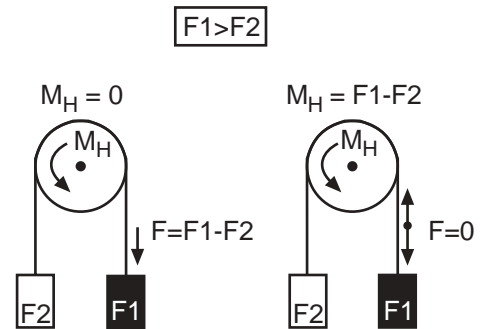
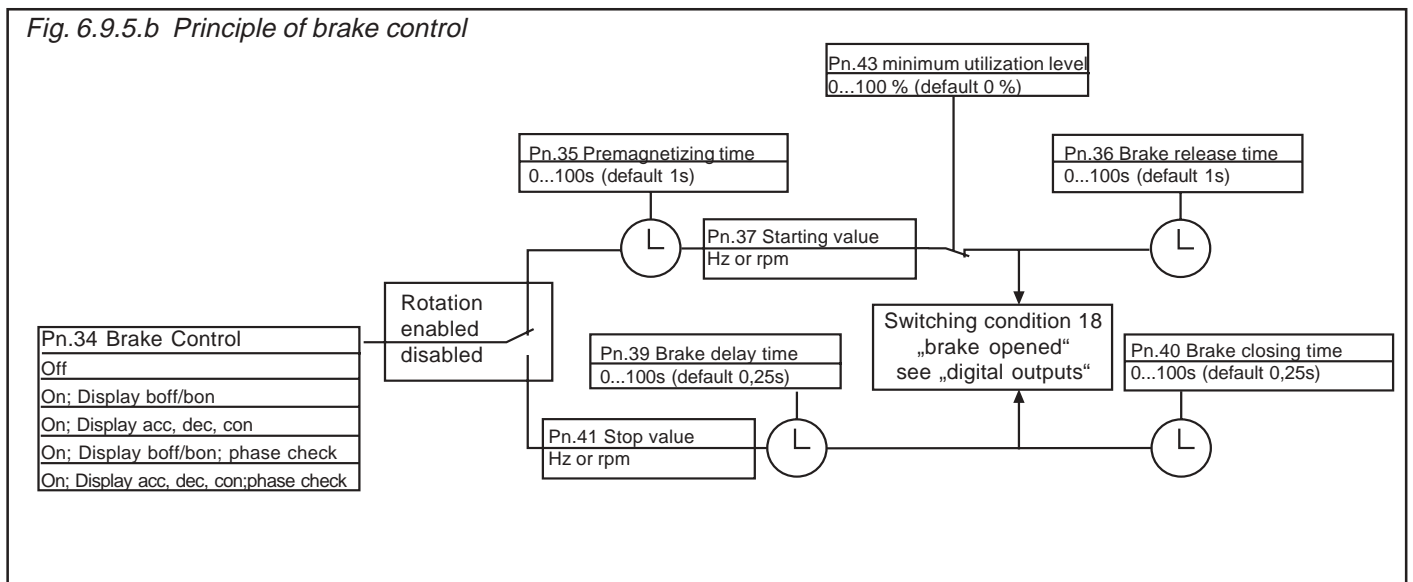
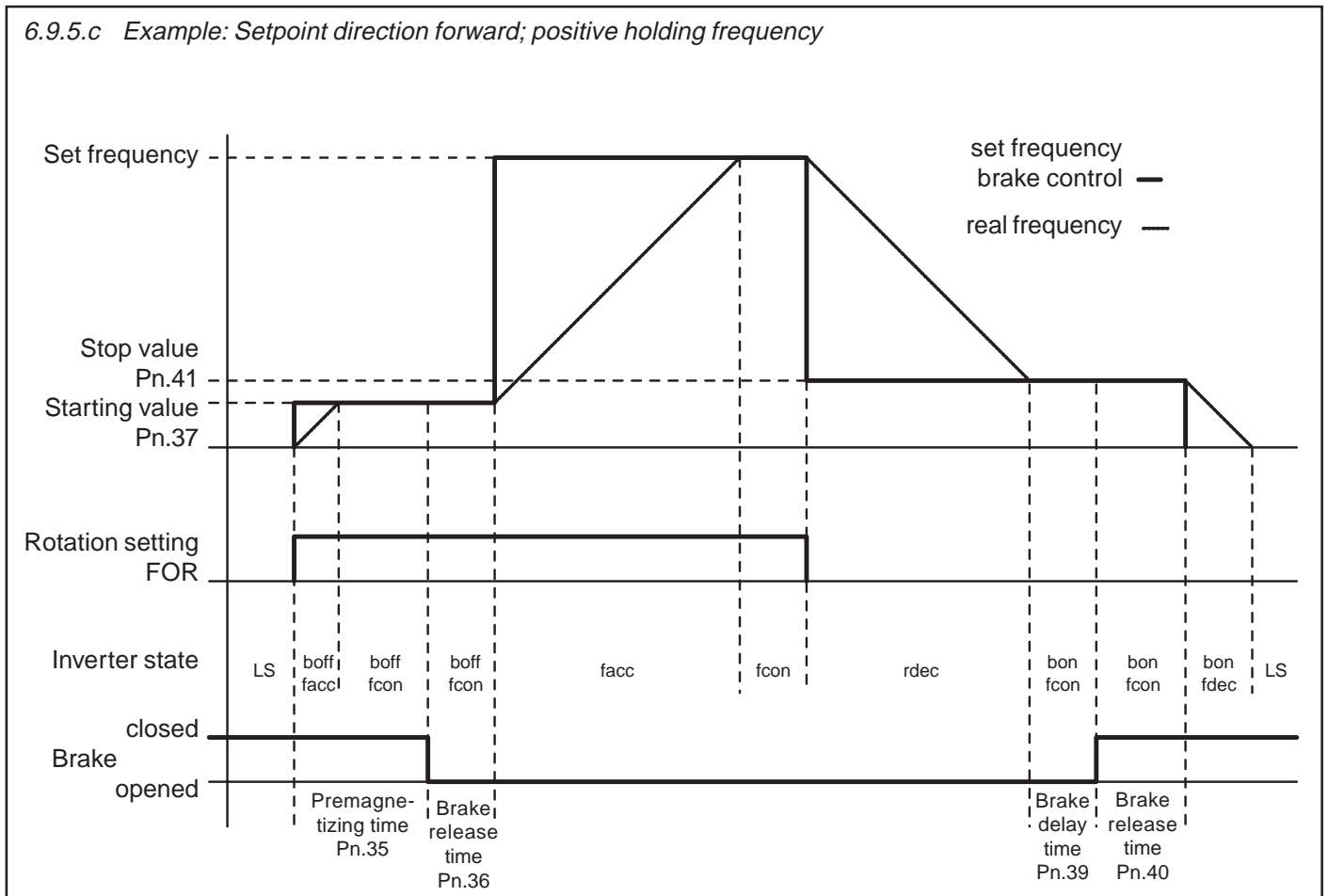


Fig. 6.9.5.b Principle of brake control



Brake control During the start, triggered by switching on the direction of rotation, a holding torque is built up first. For it a premagnetizing time (Pn.35) and a starting value (Pn.37) are preset. As a safety function the monitoring of the acceptance of the inverter can now be adjusted. Before releasing the brake the utilization is compared with the minimum utilization level (Pn.43). If the utilization is less than this level or the hardware current limit is reached, the error E. br is triggered and the brake remains engaged. If the utilization acceptance is ensured, the signal for releasing the brake is given after the time has elapsed. For an additional time (Pn.36: brake release time), in which the brake is mechanically released, the holding frequency is maintained. It then accelerates to the adjusted setpoint.

Brake release During stopping, triggered by taking away the direction of rotation, the inverter runs first to the holding frequency (Pn.41). After the brake delay time (Pn.39) the signal for engaging the brake is given. After expiration of the brake closing time (Pn.40), in which the brake takes over the utilization, it is decelerated until standstill and the inverter changes into status LS.



Mode brake control (Pn.34)

The function is activated or deactivated with this parameter. In addition the status display can be changed over. If the output phase monitoring is activated, each output phase is checked before acceleration to the starting value. If one phase is missing or in case of wrong wiring in the inverter E.br is triggered. Pn.34 is set-programmable.

Value	Function
0	Function deactivated (default)
1	Brake control active, display boff/bon
2	Brake control active, display acc/dec/con
1	Brake control active, display boff/bon, with phase monitoring
2	Brake control active, display acc/dec/con, with phase monitoring

The status display during the holding phases depends on the setting of the mode for the brake control (see Fig. 6.9.5.c).

- Pn.34 = 1/3 the status boff (release brake) or bon (engage brake) is displayed.
- Pn.34 = 2/4 the normal ramp status is displayed.

In addition to it a digital output (switching condition 18) is to be programmed for the control (see Chapter 6.3).

Minimal utilization level Error message E. br (Pn.43)

For the monitoring of the utilization acceptance through the inverter a minimal utilization level can be adjusted in this parameter. When the brake shall be released during the start, the utilization may not be less than the adjusted level. Otherwise the error E.br is triggered. Reaching the hardware current limit the error E.br is triggered too. The monitoring is deactivated when Pn.43 is set to 0.

Start value (Pn.37) The adjustable start/stop value stands in direct connection with the necessary holding torque. The preadjustment, according to following formula, is valid for rated motor torques:
 Stop value (Pn.41)

$$\text{Start-/Stop value} = \frac{(\text{no-load motor speed} - \text{rated motor speed}) \times \text{rated motor frequency}}{\text{no-load motor speed}}$$

Example: $\frac{(1500\text{rpm} - 1420\text{rpm}) \times 50\text{Hz}}{1500\text{rpm}} = 2,67 \text{ Hz}$

The direction into which the holding torque shall take effect is determined by the sign. The parameters are set-programmable.

At using the brake control the direction of rotation (oP.1) may not be set to „7“, because then no Low-Speed-Signal (LS) is output.

Used Parameters

Param.	Adr.	R/W	PROG.	ENTER	min	max	Step	default	
Pn.34	0422h	✓	✓	✓	0	4	1	0	-
Pn.35	0423h	✓	✓	-	0,00 s	100,00 s	0,01 s	0,25 s	-
Pn.36	0424h	✓	✓	-	0,00 s	100,00 s	0,01 s	0,25 s	-
Pn.37	0425h	✓	✓	-	-20 Hz	20 Hz	0,0125 Hz	0 Hz	F5-G/B depending on ud.2
	0425h	✓	✓	-	-600 rpm	600 rpm	0,125 rpm	0 Hz	F5-M/S depending on ud.2
Pn.39	0427h	✓	✓	-	0,00 s	100,00 s	0,01 s	0,25 s	-
Pn.40	0428h	✓	✓	-	0,00 s	100,00 s	0,01 s	0,25 s	-
Pn.41	0429h	✓	✓	-	-20 Hz	20 Hz	0,0125 Hz	0 Hz	F5-G/B depending on ud.2
	0429h	✓	✓	-	-600 rpm	600 rpm	0,125 rpm	0 Hz	F5-M/S depending on ud.2
Pn.43	042Bh	✓	✓	-	0	100 %	1 %	0 %	-

6.9.6 Power-Off Function

It is the task of the Power-Off function to ensure a **controlled** deceleration of the drive until standstill in case of undervoltage (e.g. due to power failure). The kinetic energy of the rotating drive is used to support the inverter DC-link voltage. As a result the inverter remains in operation and can decelerate the drive in a controlled manner. Especially in the case of parallel running drives (e.g. textile machines) the uncontrolled running down of the motors and the consequences resulting from it (thread breakage) can be avoided.

The parameter Power-Off-Mode (Pn.44) switches on the function and determines the basic behaviour:

Power-Off Mode (Pn.44)

8	7	6	5	4	3	2	1	0	Bit	Value	Function
Switch on/off of Power-Off											
x	x	x	x	x	x	x	x	0	0	0	off
x	x	x	x	x	x	x	x	1	1	1	on
Power-Off / start voltage											
x	x	x	x	x	x	x	x	0	0	0	Automatic determination of start voltage
x	x	x	x	x	x	x	x	1	2	2	Adjustment of start voltage with Pn.45
Determination of starting jump											
x	x	x	x	x	x	0	x	x	0	0	From the slip
x	x	x	x	x	x	1	x	x	4	4	From the utilization
Behaviour of drive at min. output											
x	x	x	x	0	0	x	x	x	0	0	Status Poff, modulation on, reset required
x	x	x	x	0	1	x	x	x	8	8	as above, but restart after network return (Pn.52)
x	x	x	x	0	0	x	x	x	16	16	Status PLS, modulation on, reset required
x	x	x	x	1	1	x	x	x	24	24	reserved
reserved											
x	x	x	0	x	x	x	x	x	0	0	reserved
x	x	x	1	x	x	x	x	x	32	32	reserved
Selection of setpoint											
x	0	0	x	x	x	x	x	x	0	0	Current voltage
x	0	1	x	x	x	x	x	x	64	64	DC-voltage (Pn.50)
x	1	0	x	x	x	x	x	x	128	128	actual voltage, if actual frequency is > Pn.48
x	1	1	x	x	x	x	x	x	192	192	Braking torque (Pn.47)
DC-link voltage stabilization during Power-Off											
0	x	x	x	x	x	x	x	x	0	0	Switched on
1	x	x	x	x	x	x	x	x	256	256	Switched off

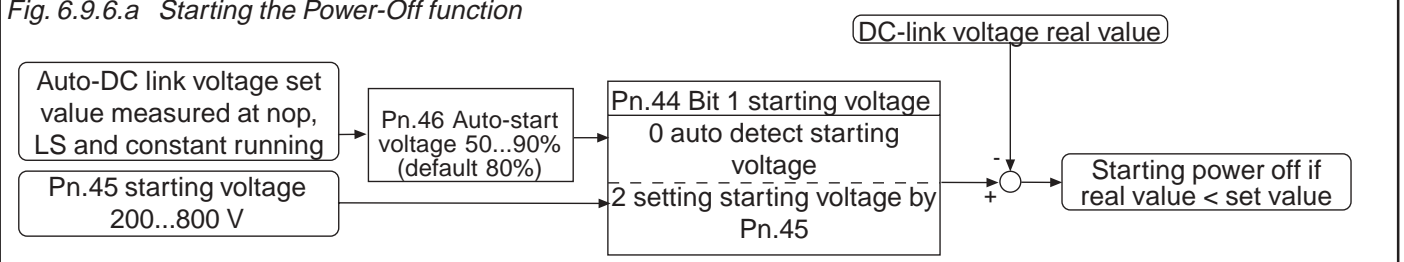
Switch on Power-Off (Pn.44 Bit 0)

The Power-Off function is switched on/off with Bit 0 of Pn.44. Parameter Pn.44 is an Enter-parameter.

Tripping of Power-Off

The Power-Off function starts when the DC-link voltage drops below a certain value, the start voltage. The start voltage can be set automatically or manually depending on Pn.44 Bit 1.

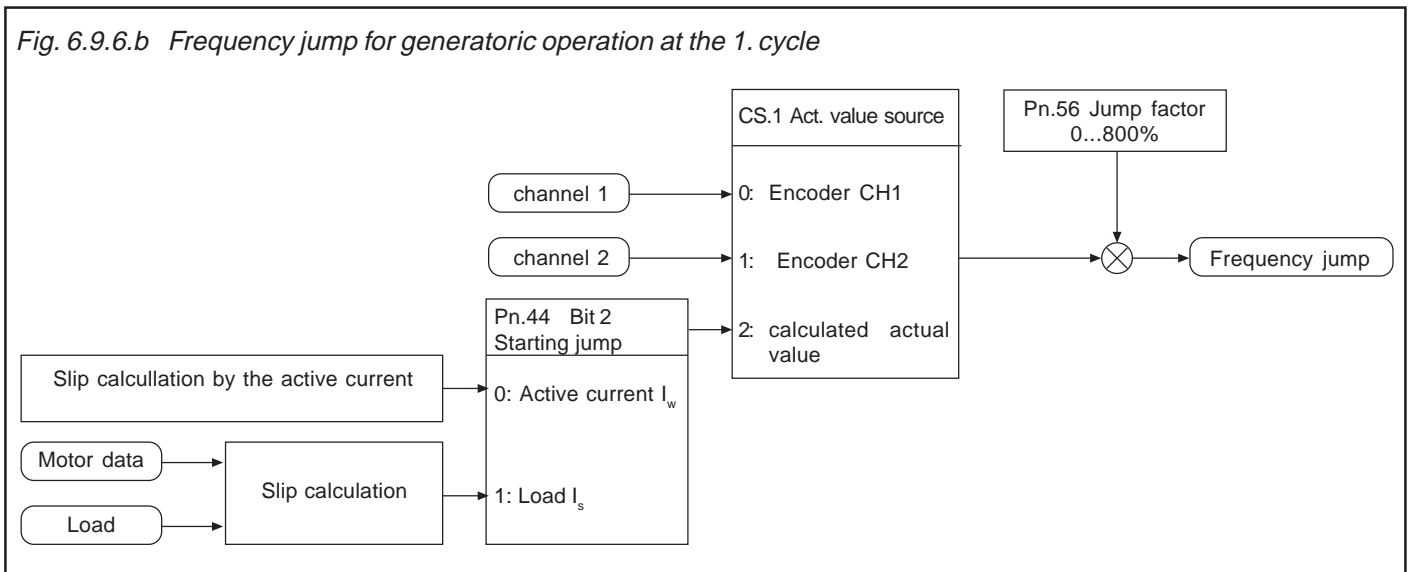
Fig. 6.9.6.a Starting the Power-Off function



Start voltage (Pn.45) With manual adjustment the starting voltage can be preset with Pn.45 in the range of 200...800 volt. For a secure range the adjusted starting voltage must be at least 50 V over the UP-threshold (UP: 400V-class=280V; 200V-class=216V DC).

Auto-Start voltage (Pn.46) With automatic starting voltage the DC-link voltage is measured in different operating states. The actual starting voltage is determined by Pn.46, which adjusts the starting voltage in percent in the range of 50...90 % of the measured value. The default setting is 80%.

If the DC-link actual voltage value drops below the starting voltage, adjusted automatically or manually, the Power-Off function is started.



Frequency jump for generatronic operation

First of all the drive must be brought into generatronic operation to enable the feed back of energy into the intermediate circuit. This is achieved by making a frequency jump, so that the speed of the drive is larger than the output rotating field speed of the inverter.

Actual value source (CS.1)

With the actual value source it is defined whether the Power-Off works as slip control (with speed detection on channel 1 or 2 value „0“ of „1“) or as active current control (without speed detection value „2“). Normally this parameter is adusted at the setup of the speed control (see Chapter 6.11) and should not be changed here.

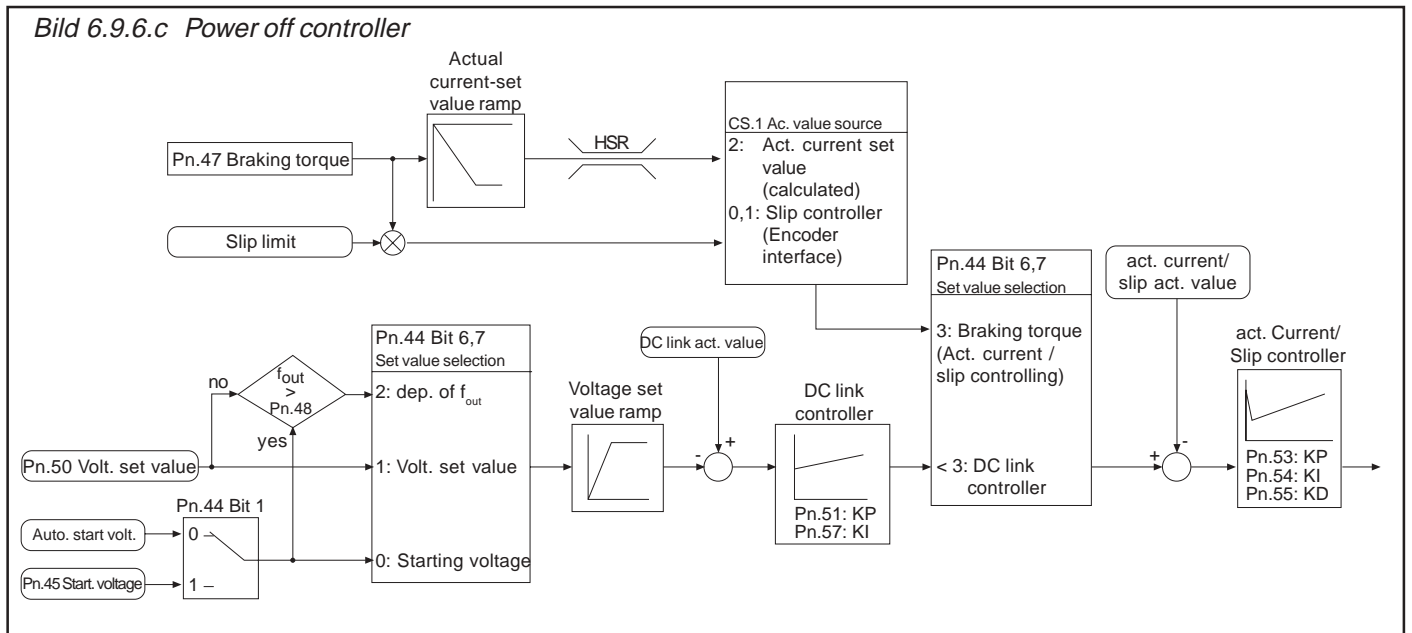
Starting jump (Pn.44 Bit 2)

The parameter Pn.44 Bit2 determines, whether the starting jump is calculated from the slip (active current) or from the utilization. This setting has no effect on slip regulation. The standard setting is from slip, but in the case of high harmonic content of the output current it can lead to false values. In that case the starting jump must be determined from the utilization. To get proper values **enter motor data into dr-parameters first.**

Enter motor data into dr-parameters! !

Jump factor (Pn.56)

By means of the jump factor the automatically determined starting jump can be adapted to the respective application.
 In case the jump factor is too small, the inverter trips to UP!
 In case the jump factor is too high, the inverter runs into the hardware current limitation. The control cannot work correctly, thus causing a wrong calculation of the active current!



Power off controller

In Fig. 6.9.3 the different controls (DC-link voltage, active current and slip control) as well as the setpoint and actual value sources are represented. The parameter CS.1 is normally defined by the encoder (see Chapter 6.11) and should not be changed here.

Starting voltage (Pn.45)

The starting voltage is used as setpoint value source, if the adjustment is Pn.44 Bit 1 = „1“ and Bit 6-7 = „0“. The starting voltage can be preset within the range of 200...800 volt .

Auto starting voltage (Pn.46)

The starting voltage is used as setpoint value source, if the adjustment is Pn.44 Bit 1 = „0“ und Bit 6-7 = „0“. With automatic starting voltage the DC-link voltage is measured in different operating states (nOP, LS or constant running). The auto starting voltage is determined by Pn.46, which adjusts the voltage in percent in the range of 50...90 % (default 80 %) of the measured value.

Braking torque (Pn.47)

Serves for the adjustment of the braking torque in the range of 0.1...100.0 %, if the drive must be stopped as quickly as possible in case of power failure. For this setting to become effective, Pn.44 Bit 6 and 7 must be set to „3“. In this case the DC-link control is disabled, i.e. it is a pure active current/slip control. The braking torque can be preset within the range of 0,1...100,0 %. Depending on CS.1 the active current control or the slip control works.

Setpoint DC-link voltage (Pn.50)

The voltage setpoint value is used as setpoint value source, if the adjustment is Pn.44 Bit 6-7 = „1“. If Bit 6-7 are adjusted to „2“, the voltage setpoint value takes effect only below the restart value (Pn.48), so that the drive still has enough energy for braking when reaching the minimum output value. On reaching the restart value the starting voltage is increased over a ramp to the voltage setpoint value. The setpoint DC-link voltage is adjusted with Pn.50 in the range of 200...800 V. This is the value to be regulated to. To ensure a safe operation the internal value is limited down. The value of the DC-link voltage in normal operation plus approx. 50 V adjusts itself as minimum value. If a braking resistor is connected, the adjusted value may not lie above the threshold of the braking resistor, else the controller cannot work (threshold 200V-class: 380V; 400V-class: 740V).

KP (UZK) (Pn.51)
KI (UZK) (Pn.57)

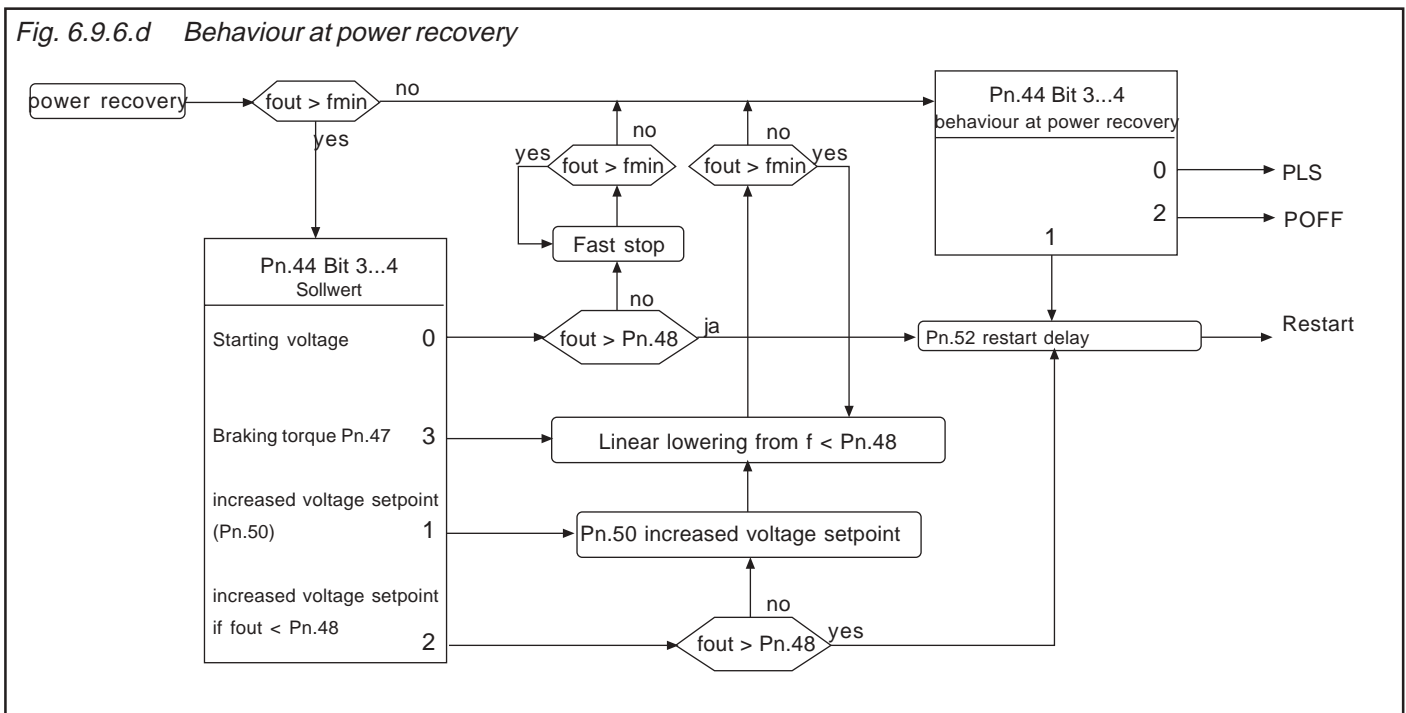
In order to better adapt the drive individually to the application, the proportional factor of the DC-link voltage controller can be adjusted with Pn.51 and the integral factor with Pn.57. In most cases the default setting will achieve sufficient results. But if it comes to overshoots or if the motor loses synchronism the value must be reduced.

Power off KP (Pn.53)
Power off KI (Pn.54)
Power off KD (Pn.55)

Pn.53 to Pn.55 are the control parameters of the active current control and the slip control. The active current control is active at C2.1 = 2 (actual value = calculated value), the slip control is active at CS.1 = 0 or 1 (actual value = measured value of channel 1 or 2).



At the active current control (without speed control) a D-part in the control has a positive effect. Pn.55 should have approx. 10-times the value of Pn.53. Since the hardware current limit should not be reached with active current control, the setpoint value is limited internally which can lead to oscillations. In that case the setpoint value can be reduced, which leads to a prolongation of the delay. If the voltage stabilisation is switched on (Pn.44 Bit 8 = „1“) and uf.9 = rated voltage, the voltage is not so high and the deceleration becomes more uniform. At the slip control (with speed detection) the D-part is unfavorable. Pn.55 should be set on 0.



Behaviour at power recovery The following parameters effect the behaviour of the inverter if the system voltage returns during the Power-Off-function

Restart value (Pn.48)

Dependent on the application the restart makes may only be sensible up to a certain value. This restart value is adusted in Pn.48.

Dependent on the setpoint value source (Pn.44 Bit 6-7) following conditions occur:

1. Regulation of the starting voltage (Pn.44 Bit 6-7 = 0):
If the output value is larger than the restart value, the restart is carried out upon power recovery. The output value is kept constant during the restart delay (Pn.52).

Afterwards it is accelerated to the current setpoint value. Below the restart value it is delayed in case of power recovery with the fast-stop-function.

2. Regulation onto the voltage setpoint, if the output value is smaller than the restart value (Pn.44 Bit 6+7 = 2):

As long as the output frequency and/or the actual speed is larger than the restart value, the inverter behaves as described under Point 1. Below the restart value the voltage setpoint value of Pn.50 is increased and with active current control (without speed detection) the control parameters of the active current control are reduced linearly with the output value.

3. Regulation onto the voltage setpoint Pn.50 or braking torque Pn.47 (Pn.44 Bit 6+7 = 1 or 3):

The control parameters of the active current control (without speed detection) are reduced below the restart value linearly with the output value.

Restart at minimum Output value (Pn.44 Bit 3, 4)

Bit 3 and 4 of Pn.44 determine the behaviour of the drive upon attaining the minimum output value.

- Bit 3 = „0“ and Bit 4 = „0“; the inverter modulates independent of a set direction of rotation with the adjusted boost and is in status „POFF“ (Caution: Motor heating). A reset is necessary for the restart.
- Bit 3 = „1“ and Bit 4 = „0“; the inverter modulates independent of a set direction of rotation with the adjusted boost and is in status „POFF“. After expiration of the restart delay Pn.52 (if adjusted) the inverter restarts automatically.
- Bit 3 = „0“ and Bit 4 = „1“; the inverter switches off the modulation and is in status „PLS“. A reset is necessary for the restart.

Restart delay (Pn.52)

The restart delay is the time during which the output value is kept constant after power recovery, if a restart is allowed. It is adjustable within the range of 0...100 s (Default 0 s). After expiration of the time it is accelerated again onto the current setpoint value.

Examples

To better understand the correlation, the operating modes are explained according to the control types in the following section.

Function description F5-G

If the Power-Off-function is switched on (Pn.44 Bit 0 = 1), it becomes active if the DC-link voltage drops below the starting voltage value. In the first cycle the frequency jump is given which shall put the drive into no-load running. Afterwards it is regulated onto the DC-link voltage or only onto the active current respectively slip depending on the setpoint value source. The changeover between active current control (without speed detection) and slip control (with speed detection) takes place over cs.1. At cs.1 = 2 (actual value = calculated value) the active current control is active, at cs.1 = 0 or 1 the slip control is active.

Power loss ride-through

Set value source

Starting voltage (Pn.44 Bit 6-7 = 0) or setpoint DC-link voltage Pn.50, if output value < restart value Pn.48 (Pn.44 Bit 6-7 = 2)

In this mode the motor shall be operated almost in no-load operation and shall feed

© KEB Antriebstechnik, 2002 All rights reserved	Name: Basis KEB COMBIVERT F5	Date 18.04.02	Chapter 6	Section 9	Page 23
--	--	------------------	---------------------	---------------------	-------------------

back only the energy which the inverter requires for operation. The starting voltage is at the same time the setpoint value for the DC-link control. The control value is the setpoint value of the slip control.

In case of weak supply systems it is recommended to select the automatic starting voltage, since in this case the starting voltage value is adapted to slow voltage fluctuations.

Restart at power recovery

In mode 0 the power recovery is constantly detected and in mode 2 up to reaching the restart threshold. An immediate restart upon power recovery is possible.

After detecting the power recovery the restart delay (Pn.52) runs down and the drive accelerates to the current setpoint value.

Behaviour below the restart threshold

- Setpoint value = starting voltage (Pn.44 Bit 6-7 = 0):

An immediate restart is not executed below the restart threshold (Pn.48). The drive decelerates with the fast-stop function (Pn.58..60) and then behaves according to the adjustment in Pn.44 Bit 3-4.

- Increase voltage setpoint value (Pn.44 Bit 6-7 = 2):

In order to have more energy to slow down the flywheel masses when the minimum output value is reached, the voltage setpoint value can be raised to the voltage setpoint value Pn.50 (Pn.44 Bit 6-7 = 2) should it fall below the restart threshold. In this case the control remains active with the increased setpoint value. At small speeds the drive supplies no more energy. For operation without speed detection the control must be very smooth in this range to prevent stalling. Below the restart value the control parameters of the active current control are lowered linearly with the output frequency.

Emergency stop with braking module

Set value source:

Braking torque Pn.47 (Pn.44 Bit 6-7 = 3)

In this mode the drive is to be stopped as fast as possible. As the refed energy can be very high, a braking resistor is necessary.

The DC-link voltage controller is not active. The drive decelerates with the quick-stop function Pn.60..61 (see Chapt. 6.7.7) and behaves then in accordance with the setting in Pn.44 Bit 3-4.

At small speeds the drive supplies no more energy. For operation without speed detection (active current control) the control must be very smooth in this range to prevent stalling. It is possible to adjust the restart value (Pn.48). Below the restart value the control parameters of the active current control are lowered linearly with the output frequency.

Emergency stop without braking module

Set value source:

Increased voltage setpoint value Pn.50 (Pn.44 Bit 6-7 = 1)

In some cases one can do without a braking module with the Emergency-Stop function, if the losses in the motor are very high at high DC-link voltage.

The voltage stabilisation should be switched off in this case. This can be done with Pn.44 Bit 8 = 1 during Power-Off.

The DC-link voltage control is active. It is always decelerated onto the minimum output value. Accordingly the performance results from the adjustment of Pn.44 Bit 3-4.

At small speeds the drive supplies no more energy. For operation without speed detection the control must be very smooth in this range to prevent stalling. It is possible to adjust the restart value (Pn.48). Below the restart value the control parameters of the active current control are lowered linearly with the output frequency.

Functional sequence F5-M If Power-Off is switched on (Pn.44 Bit 0 = 1), it becomes active when the DC-link voltage drops below the starting voltage. The behaviour depends on the adjustment of the setpoint source (Pn.44 Bit 6-7). The behaviour setpoint source = voltage source (on.44 Bit 6-7 = 1 or 2) is the same as with voltage setpoint = starting voltage (Pn.44 Bit 6-7 = 0). .

For F5-M only the parameters Pn.44..46, Pn.48, Pn.51, Pn.52 and Pn.57 are visible. In Pn.44 the Bits 2 and 8 are ineffective.

The Power-Off function is switched off in controlled operation (cs.0 Bit 0..2 = 0..3).

Bridging of mains gaps Set value source:
Starting voltage (Pn.44 Bit 6-7 = 0)

In this mode the motor shall be operated almost in no-load operation and only recover the energy which the inverter requires for the operation. The starting voltage is also the setpoint value of the DC-link voltage controller. The value of manipulated variable represents the torque limit of the speed controller.

In case of weak supply systems it is recommended to choose the automatic starting voltage, as in this case the starting voltage value is adapted to slow voltage fluctuations. In the first cycle the limit of the speed control is adjusted to the measured slip, so that the drive is put into no-load operation.

Restart at power recovery

Only in this mode the system recovery can be constantly detected. An immediate restart upon system recovery is possible. After detecting the system recovery the restart delay (Pn.52) runs and the drive accelerates to the current setpoint.

An immediate restart is not executed below the restart value (Pn.48). The drive decelerates with the quick-stop function Pn.60..61 (see Chapt. 6.7.7) and behaves then in accordance with the setting in Pn.44 Bit 3-4.

Emergency stop with braking module Set value source:
Braking torque Pn.47 (Pn.44 Bit 6-7 = 3)


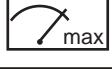

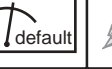

In this mode the drive is to be stopped as fast as possible. As the refed energy can be very high, a braking resistor is necessary.

The DC-link voltage controller is not active. The drive decelerates with the quick-stop function Pn.60..61 (see Chapt. 6.7.7) and behaves then in accordance with the setting in Pn.44 Bit 3-4.

Function description F5-S If Power-Off is switched on (Pn.44 Bit 0 = 1) it becomes active when the DC-link voltage drops below the starting voltage. The drive decelerates with the quick-stop function Pn.60..61 and behaves then in accordance with the setting in Pn.44 Bit 3-4.

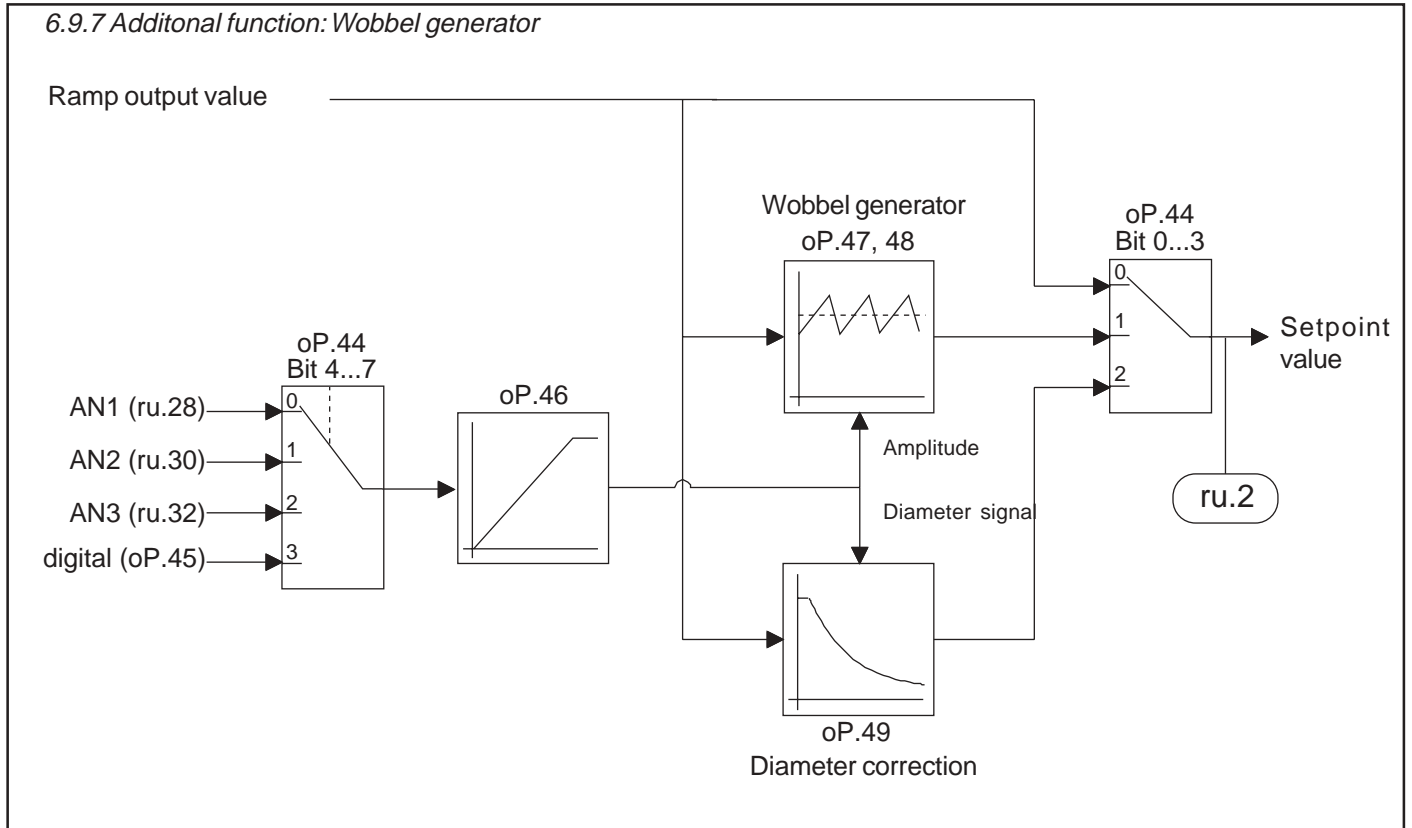
For F5-S only the parameters Pn.44..46 and Pn.52 are visible. At Pn.44 only the Bits 0, 1, and 3..4 are active.

Used Parameters

Param.	Adr.	RW	PROG.	ENTER					
Pn.44	042Ch	✓	-	✓	0	511	1	0	-
Pn.45	042Dh	✓	-	-	200 V	800 V	1 V	290/500 V	dep. of the voltage class
Pn.46	042Eh	✓	-	-	50 %	90 %	1 %	80 %	-
Pn.47	042Fh	✓	-	-	0,0 %	100,0 %	0,1 %	0 %	only F5-G/B
Pn.48	0430h	✓	-	-	0 Hz	400 Hz	0,0125 Hz	0 Hz	only F5-G/B
	0430h	✓	-	-	0 min ⁻¹	4000 min ⁻¹	0,125 min ⁻¹	0 min ⁻¹	only F5-M ; dep.on ud.2
Pn.50	0432h	✓	-	-	200 V	800 V	1 V	290/500 V	dep. of the voltage class
Pn.51	0433h	✓	-	-	0	32767	1	128 (512)	only F5-G; F5-M; (F5-B)
Pn.52	0434h	✓	-	-	0,00 s	100,00 s	0,01 s	0,00 s	-
Pn.53	0435h	✓	-	-	0	32767	1	800 (50)	only F5-G; (F5-B)
Pn.54	0436h	✓	-	-	0	32767	1	800 (50)	only F5-G; (F5-B)
Pn.55	0437h	✓	-	-	0	32767	1	0	only F5-G/B
Pn.56	0438h	✓	-	-	0 %	800 %	1 %	100 %	only F5-G/B
Pn.57	0439h	✓	-	-	0	32767	1	5	only F5-G; F5-M

6.9.7 Wobbel Function
(not at F5-B)

The wobbel generator enables in period and amplitude changeable sawtooth process of the setpoint value. It is activated with the parameter oP.44 Bit 0...3 = „1“.



Additional function/ Mode (oP.44 Bit 0...3) Different functions can be activated with oP.44 Bit 0...3. The value is to be added to Bit 4...7.

oP.44 Bit 0...3	Function
0	no external function activated
1	Wobbel generator activated
2	Diameter correction (see Chapt. 6.9.8)
3...15	reserved

Additional function/ Source (oP.44 Bit 4...7) The input source for the functions is determined with oP.44 Bit 4...7. The value is to be added to Bit 0...3.

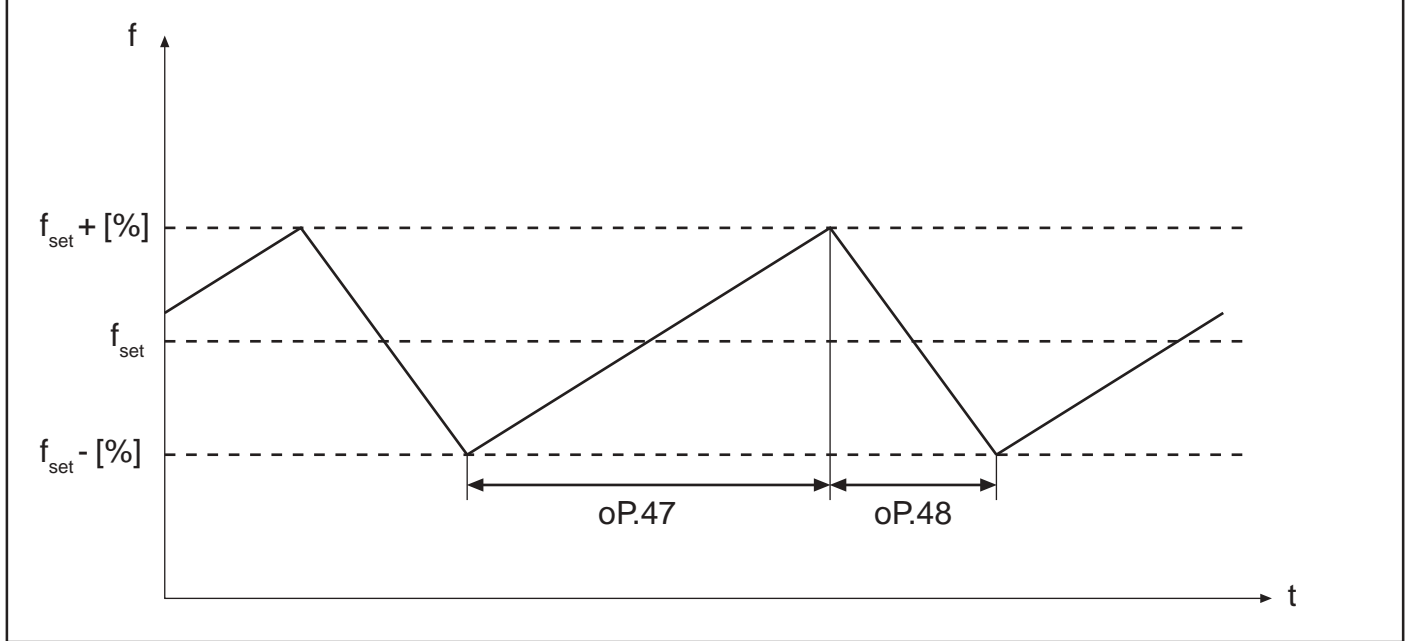
oP.44 Bit 4...7	Function
0	Analog input AN1
16	Analog input AN2
32	Analog input AN3
48	Digital presetting with oP.45

Additional function digital setting (oP.45) If the value „49“ (sweep function with digital specification) is adjusted in oP.44, the sweep amplitude is preset with oP.45 within the range of 0...100 %.

Additional function acceleration/deceleration (oP.46) With oP.46 a time can be preset between 0...20 s, with which the sweep amplitude rises/falls. The entered value refers to a sweep amplitude of 100 %.

Wobbel generator With oP.47 the acceleration time and with oP.48 the deceleration is adjusted in each case within the range of 0...20.00 s. Together the two parameters result in the period duration of the wobbel period.
 Acceleration time (oP.47)
 Deceleration time (oP.48)

6.9.7.b Acceleration and deceleration times of the wobbel generator



Used Parameters

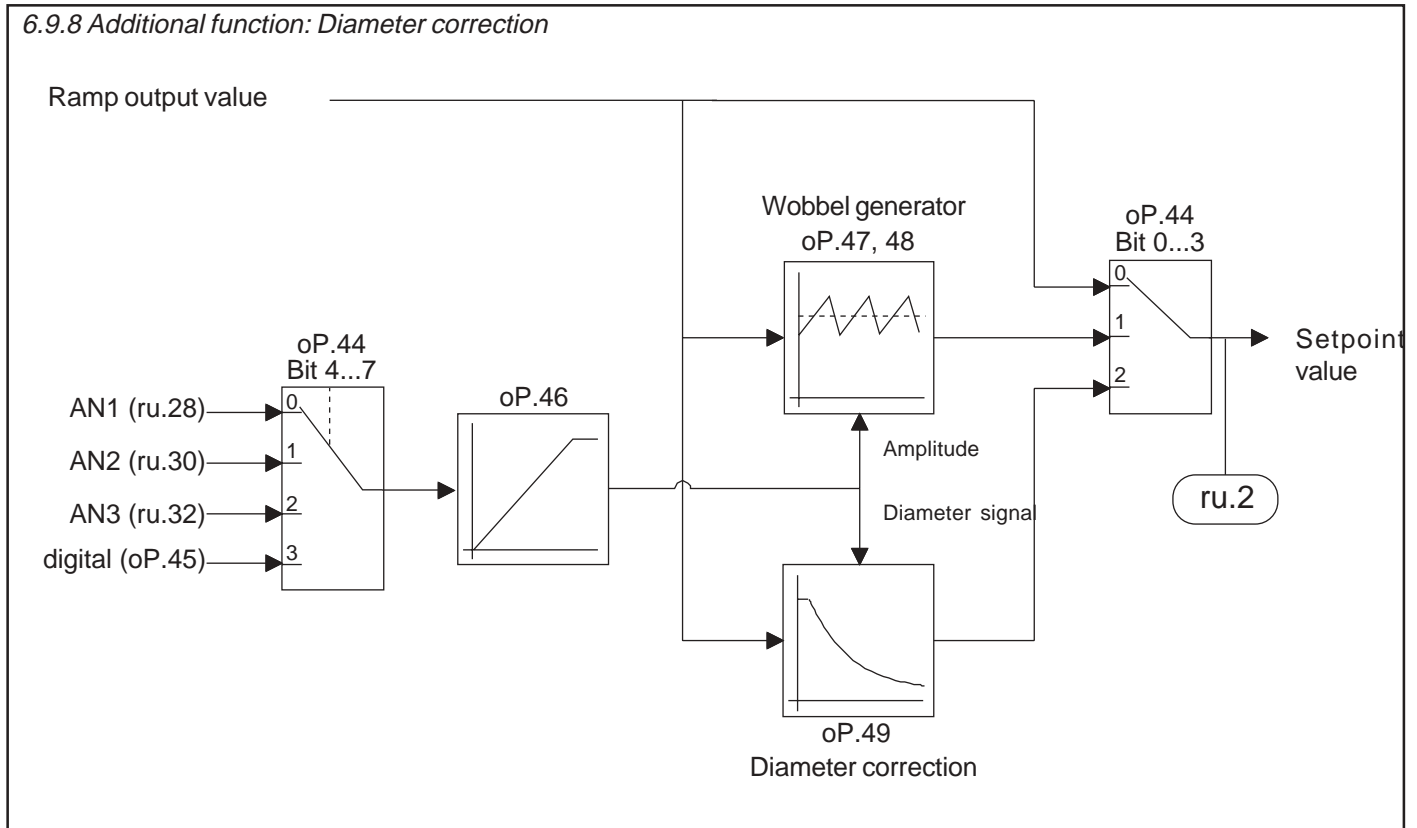
Param.	Adr.	RW	PROG.	ENTER	min	max	Step	default	
oP.44	032Ch	✓	-	✓	0	63	1	0	-
oP.45	032Dh	✓	-	-	0,00 %	100,00 %	0,01 %	0,00 %	-
oP.46	032Eh	✓	-	-	0,00 s	20,00 s	0,01 s	10,00 s	-
oP.47	032Fh	✓	-	-	0,00 s	20,00 s	0,01 s	10,00 s	-
oP.48	0330h	✓	-	-	0,00 s	20,00 s	0,01 s	10,00 s	-

6.9.8 Diameter Correction

Through the use of the diameter correction the tool path feedrate of a winding product can be kept constant at changing diameter of the reel bale.

(not at F5-B)

6.9.8 Additional function: Diameter correction



Additional function / Mode
(oP.44 Bit 0...3)

Different functions can be activated with oP.44 Bit 0...3. The value is to be added to Bit 4...7.

oP.44 Bit 0...3	Function
0	no external function activated
1	Wobbel generator (see Chapter 6.9.7)
2	Diameter correction activated
3...15	reserved

Additional function / Source
(oP.44 Bit 4...7)

The input source for the functions is determined with oP.44 Bit 4...7. The value is to be added to Bit 0...3.

oP.44 Bit 4...7	Function
0	Analog input AN1
16	Analog input AN2
32	Analog input AN3
48	Digital presetting with oP.45

Additional function
digital presetting (oP.45)

If the value „50“ (diameter correction with digital specification) is adjusted in oP.44, the diameter signal can be preset with oP.45 within the range of 0...100 %.

Diameter correction dmin/dmax (oP.49) The diameter signal is evaluated within the range of 0% to 100%. Values < 0% are set to 0%, values > 100% are limited to 100%.
 The diameter signal of 0% corresponds to the minimum diameter of the reel bale (d_{min}). The output speed of the ramp generator is not changed in this case. A diameter signal of 100% corresponds to the maximum diameter of the reel bale (d_{max}). In order to be able to calculate the speed change the program requires the ratio of minimum to maximum diameter (d_{min}/d_{max}).
 The ratio of minimum to maximum diameter (d_{min}/d_{max}) is preset by way of oP.49 and can be adjusted within the range of 0.010...0.990 with a resolution of 0.001.

The corrected output frequency of the ramp generator is determined as follows:

$$fn_presetting = \frac{fn_Ramp}{1+DS \cdot (1/oP.49-1)}$$

fn_Ramp: Output frequency/speed of ramp generator
 fn_presetting: Corrected output frequency/speed
 DS: Diameter signal 0 - 100% (0 to 1)
 oP.49: (d_{min}/d_{max})

Additional function Acceleration/Deceleration (oP.46) The rate of change of the diameter signal can be limited by a ramp generator. By way of oP.46 the time can be preset within the range of 0.0...20 s, which is required for a signal difference of 0...100%.

Used Parameters

Param.	Adr.	RW	PROG.	ENTER	min	max	Step	default	
oP.44	032Ch	✓	-	✓	0	63	1	0	-
oP.45	032Dh	✓	-	-	0,00 %	100,00 %	0,01 %	0,00 %	-
oP.46	032Eh	✓	-	-	0,00 s	20,00 s	0,01 s	10,00 s	-
oP.49	0331h	✓	✓	-	0,010	0,990	0,001	0,500	-

6.9.9 Positioning Function

(only at F5-G/B)

The positioning function enables the approach of a position with a signal from different frequencies. The positioning procedure is triggered by disabling the direction of rotation through an external signal (e.g. through set-changeover). The positioning is executed correctly only if at triggering the positioning the maximum frequency of the positioning set is not exceeded and no s-curves are used. During the positioning procedure the status 'Positioning' is displayed (value 83, display 'POSI').

Calculation of the frequency-dependent constant running time

In order to always travel the same distance in the case of different frequencies, the drive continues to run with constant frequency after starting the positioning until the position is reached with the adjusted deceleration. The frequency-dependent constant running time is calculated as follows:

$$t_{const} = \frac{t_{dec}}{2} \cdot \left(\frac{f_{max}^2}{f_{actual}} - f_{actual} \right)$$

t_{const}: frequency-dependent constant running time [sec.]
t_{dec}: adjusted deceleration time [sec.]
 Reference frequency: 100Hz / 200Hz / 400Hz (dependent on ud.2)
f_{max}: maximum frequenz [Hz]
f_{actual}: actual frequency[Hz] on triggering the positioning

Positioning delay (Pn.63)

With parameter Pn.63 a shifting of the stop position can be adjusted, which entails an additional constant running time. Thus the shifting of the initiator can be omitted. The additional constant running time is also frequency-dependent and is calculated as follows:

$$t_{delay} = \frac{Pn.63 \cdot f_{max}}{f_{actual}}$$

t_{delay}: additional constant running time [sec.]
Pn.63: positioning / delay [sec.]
f_{max}: maximum frequency [Hz]
f_{actual}: actual frequency [Hz] on triggering the positioning

The parameter is not standardized and can be adjusted within the range of 0.01...327.67 s. The value -1 switches off the positioning function in the appropriate set.

Pn.63	Function
-0,02	Positioning function switched on; no shifting of the stop function; set changeover during the positioning possible
-0,01	Positioning function switched off (standard)
0,00...327,67 s	Positioning function switched on; positioning delay by the adjusted value, set changeover during the positioning not possible .

Waiting period after reaching the position (fr.6)

As the positioning is usually triggered by a pulse signal, the set-changeover during the positioning procedure is disabled. The set switch-off delay (fr.6) starts only after the positioning is completed.

Used Parameters

Param.	Addr.	RW	PROG.	ENTER	min	max	Step	default	
Pn.63	043Fh	✓	✓	✓	-1 s	326,76 s	0,01 s	-0,01 s	-0,01 = off; -0,02= abort
Fr.5	0905h	✓	✓	-	0,00 s	2,55 s	0,01 s	0,00 s	-
Fr.6	0906h	✓	✓	-	0,00 s	2,55 s	0,01 s	0,00 s	-

Example 1 The drive runs a distance, positions and remains at the stop position for a time. The new cycle starts.

Download list:

Set	Parameter	Value	Notes
0	Ud01 Password	440	
0	Fr01 Copy parameter set	-2: def. cust.para	all sets
0-1	oP00 Reference source	0: Analog REF	
0	oP01 Rotation source	2: F/R, 0-lim.	Set 0: running
1	oP01 Rotation source	0: dig., 0-lim.	Set 1: positioning
1	oP02 Rotation setting	0: low speed	
0-1	oP10 Max. reference forward	70,0000 Hz	The max. setpoint value must be the same in all sets.
0-1	oP28 Acc. time forward	0,01 s	
0-1	oP30 Dec. time forward	0,20 s	
0	Pn63 Positioning delay	-1: off	
1	Pn63 Positioning delay	5,00 s	Shifting of the stop position
0	Fr02 Parameter set source	3: term. inp. coded ST-I1-ID	
0	Fr05 Set activation delay	1,00 s	Additional break at the stop position
1	Fr05 Set activation delay	0,00 s	This time must be = 0
0	Fr06 Set deactivation delay	0,00 s	This time must be = 0
1	Fr06 Set deactivation delay	2,55 s	Break at the stop position
0	Fr07 Para. set input selection	16: I1	
0	di11 I1 Function	2048: Set selection initiator signal	

Exsample 2 The drive runs with different speed back and forth and always reverses at the same points.

Downloadlist:

Set	Parameter	Value	Notes
0	Ud01 Password	440	
0	Fr01 Copy parameter set	-2: def. cust.para all sets	
0-3	oP00 Reference source	0: Analog REF	
0-3	oP01 Rotation source	0: dig.(op.2), 0-lim.	
0	oP02 Rotation setting	1: forward	Set 0: clockwise rotation
1	oP02 Rotation setting	0: low speed	Set 1: clockwise rotation positioning
2	oP02 Rotation setting	2: reverse	Set 2: counterclockwise rotation
3	oP02 Rotation setting	0: low speed	Set 3: counterclockwise positioning
0-3	oP10 Max. reference forward	70,0000 Hz	The max. setpoint value must be the same in all sets.
0-3	oP11 Max. reference reverse	-1: = see oP.10	The max. setpoint value can be different for the direction of rotation.
0-3	oP28 Acc. time forward	0,10 s	
0-3	oP30 Dec. time forward	0,10 s	
0	Pn63 Positioning delay	-1: off	
1	Pn63 Positioning delay	0,8 s	Shifting of the position at clockwise rotation
2	Pn63 Positioning delay	-1: off	
3	Pn63 Positioning delay	3,1 s	Shifting the position at counterclockwise rotation
0	Fr02 Parameter set source	2: terminal binary coded	
0	Fr05 Set activation delay	0,00 s	Additional break between counterclockwise and clockwise rotation
1	Fr05 Set activation delay	0,00 s	This time must be = 0
2	Fr05 Set activation delay	0,00 s	Additional break between clockwise and counterclockwise rotation
3	Fr05 Set activation delay	0,00 s	This time must be = 0
0	Fr06 Set deactivation delay	0,00 s	This time must be = 0
1	Fr06 Set deactivation delay	1,00 s	Break between clockwise and counterclockwise rotation
2	Fr06 Set deactivation delay	0,00 s	This time must be = 0
3	Fr06 Set deactivation delay	1,00 s	Break between counterclockwise and clockwise rotation
0	Fr07 Para. set input selection	272: I1+IA	
0	Fr11 Reset set input selection	0: no input	
0	di11 I1 Function	2048: Set sel.	Initiator signal
0	di15 IA Function	2048: Set sel.	Changeover between clockwise and counterclockwise rotation
0	do04 Condition 1	0: off	Initiator active: -> set 1
1	do04 Condition 1	1: on	Positioning completed: -> set 2
2	do04 Condition 1	1: on	Initiator active: -> set 3
3	do04 Condition 1	0: off	Positioning completed: -> set 0

6.9.10 Analog setting of parameter values

With this function it is possible to preset parameter values analog. The AUX-function or the motor-poti function can be adjusted as source.

Source analog parameter setting (An.53)

This parameter determines whether the analog parameter setting occurs via the motor-poti or the aux-function.

an.53	Function
0	AUX
1	Motor-poti function

Target analog parameter setting (An.54)

The Bus-address of the parameter, that is to be adjusted in analog mode, is adjusted here (see Chapter 5). Following parameters can be adjusted:

- uF.1 / 7
- cn. 4 / 5 / 6
- An.32 / 37 / 42 / 48
- LE.0 / 1 / 2 / 3 / 4 / 5 / 6 / 7
- cS.6 / 9
- Ec.4 / 14

In case an invalid parameter address is selected, the message „ldAtA“ (or „data invalid“ at COMBIVIS) is output and the setting is ignored.

Offset analog parameter setting (An.55)

Defines the parameter value, that adjusts itself at 0 % analog parameter setting. The parameter value must be entered with the internal standardization of the target parameter.

$$\text{Value to be adjusted} = \frac{\text{Desired value of target parameter}}{\text{Resolution of target parameter}}$$

Maximal value analog parameter setting (An.56)

Defines the parameter value, that adjusts itself at 100 % analog parameter setting. The parameter value must be entered with the internal standardization of the target parameter.



The analog parameter setting is not programmable. If a programmable parameter is adjusted as target parameter, then the target set adjusted in fr.9 is valid.

Used Parameters

Param.	Adr.	RW	PROG.	ENTER	min	max	Step	default	
An.53	0A35h	✓	-	✓	0	1	1	0	-
An.54	0A36h	✓	-	✓	-1: oFF	7FFFh	0001h	-1: oFF	-
An.55	0A37h	✓	-	✓	-2147483648	2147483647	1	0	-
An.55	0A37h	✓	-	✓	-2147483648	2147483647	1	0	-
An.56	0A38h	✓	-	✓	-2147483648	2147483647	1	0	-

- 1. Introduction
- 2. Summary
- 3. Hardware
- 4. Operation
- 5. Parameter
- 6. Functions**
- 7. Start-up
- 8. Special Operation
- 9. Error Assistance
- 10. Project Planning
- 11. Networks
- 12. Annex

- 6.1 Operating and Appliance Date
- 6.2 Analog In- and Outputs
- 6.3 Digital In- and Outputs
- 6.4 Set Value and Ramp Adjustment
- 6.5 Voltage-/Frequency Characteristic (U/f) Adjustment
- 6.6 Motor Data Adjustment
- 6.7 Protective Functions
- 6.8 Parameter Sets
- 6.9 Special Functions
- 6.10 Encoder Interface**
- 6.11 SMM
- 6.12 Technology Control
- 6.13 CP-Parameter Definition

- 6.10.1 Designs 3
- 6.10.2 Encoder Interface Channel 1 .. 4
- 6.10.3 Encoder Interface Channel 2... 5
- 6.10.4 Power Supply of Encoder 7
- 6.10.5 Selection of Encoder 8
- 6.10.6 Basic Settings 10
- 6.10.7 Additional Parameters 13
- 6.10.8 Used Parameters 14

Chapter 6	Section 10	Page 2	Date 28.01.02	Name: Basis KEB COMBIVERT F5	© KEB Antriebstechnik, 2002 All rights reserved
---------------------	----------------------	------------------	------------------	--	--

6.10 Encoder Interface

(not for B-housing)

The KEB COMBIVERT F5 supports two from each other separated encoder channels. Each encoder channel can support following interface dependent on the available hardware:

6.10.1 Designs

Encoder channel 1 (X3A)

- is a 15-pole incremental encoder input for rectangular signals

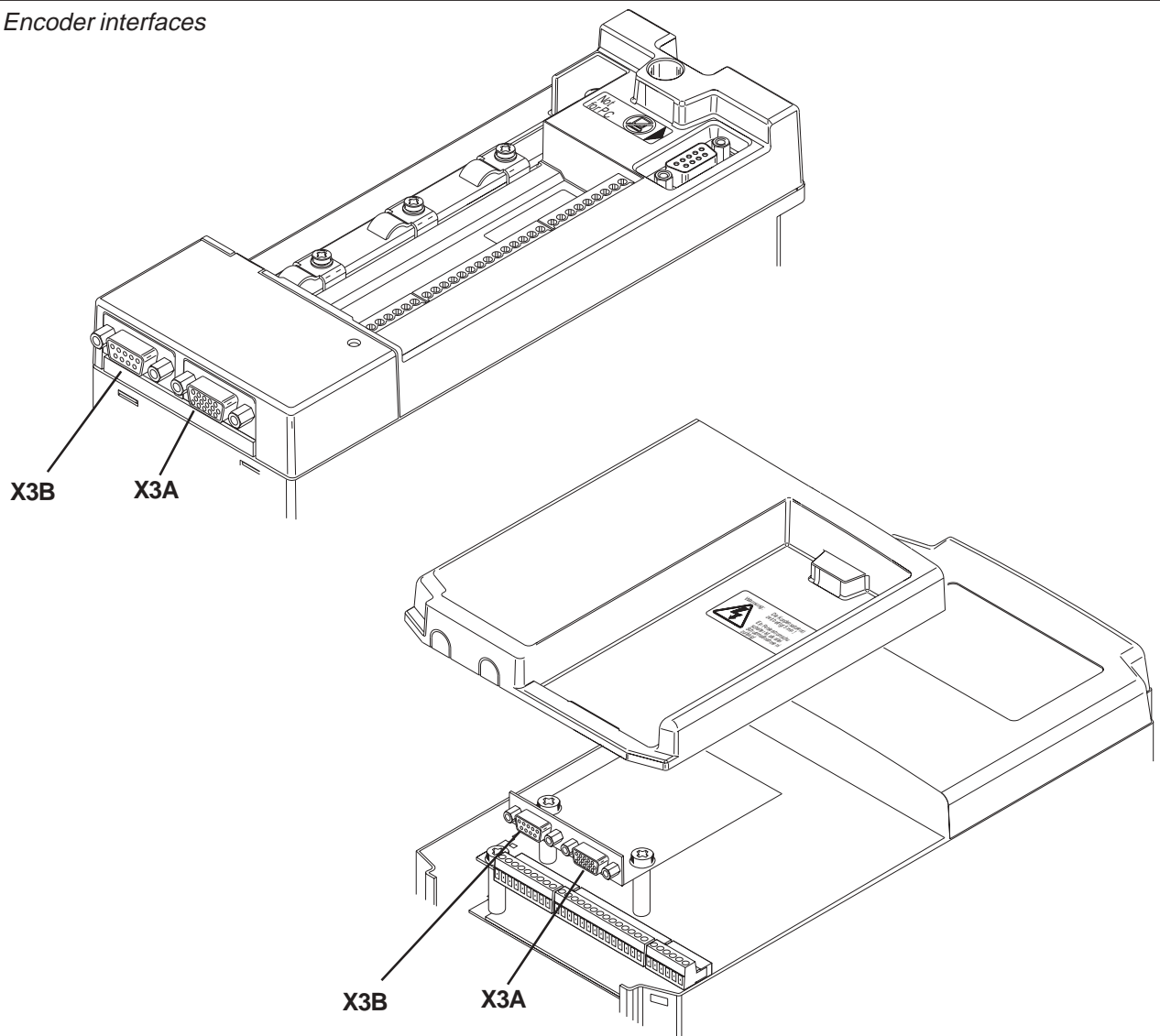
Encoder channel 2 (X3B) can support following interfaces

- 9-pole incremental encoder input for rectangular signal
- Incremental encoder output
- Incremental encoder In-/Output

Further Interfaces (describes in separate manuals)

- Synchronous serial interface (SSI)
- Tachometer input
- Initiator input
- Hiperface

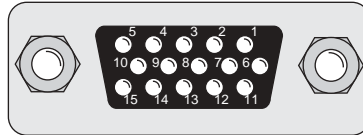
6.10.1 Encoder interfaces



6.10.2 Encoder Interface Channel 1 (X3A)

Pin description

Fig. 6.10.2 Encoder interface channel 1 (X3A)



! Only when the inverter is switched off and the voltage supply is disconnected may the plug be pulled out or plugged in!

Signal	X3A	Description
U_{var}	11	Supply voltage for encoder
+5,2 V	12	Supply voltage for encoder
0 V	13	Reference potential
A	8	Signal input A
\bar{A}	3	Signal input A inverted
B	9	Signal input B
\bar{B}	4	Signal input B inverted
N	15	Reference marking input N
\bar{N}	14	Reference marking input N inverted
Shield	Housing	Shielding

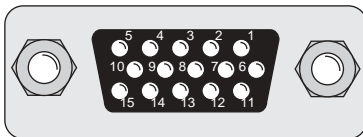
Inputs The signal and reference marking inputs can be triggered with rectangular pulses. The signal inputs must generally be connected. The reference marking signals are only needed for the reference point approach in the positioning operation (F5-M/S. Following specifications apply to the encoder interface 1 (X3A):

- max. operating frequency of input $f_c = 300$ kHz
- internal terminating resistor $R_t = 150 \Omega$
- 2...5 V high level at rectangular signals

Please contact KEB regarding encoder inputs with HTL-level.

Resolver interface (default at F5-S)

Bild 6.10.2.a Resolver interface channel 1 (X3A)



! Only when the inverter is switched off and the voltage supply is disconnected may the plug be pulled out or plugged in!

Signal	X3A	KEB servo motor	Description
SIN-	3	1	Sinus signal cable inverted
SIN+	8	10	Sinus signal cable
REF-	5	5	Reference signal inverted
REF+	10	7	Reference signal
COS-	4	2	Cosinus signal cable inverted
COS+	9	11	Cosinus signal cable
GND	14	-	Shielding of the signal cables
Shield	housing	housing	Shielding of the hole cable

Bild 6.10.2.b Resolver connector at the KEB servo motor

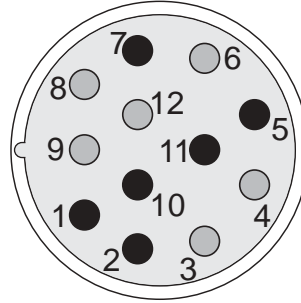
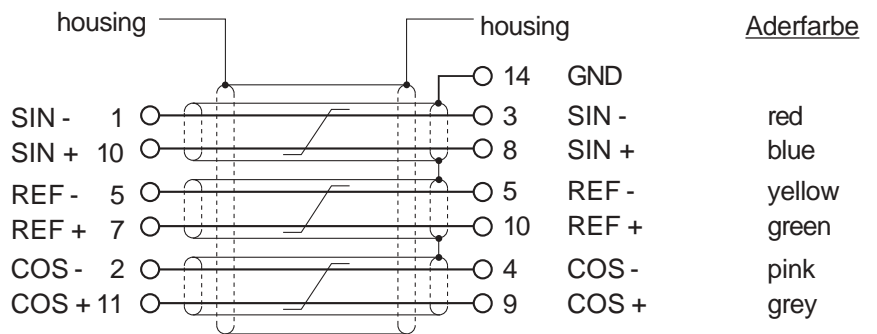
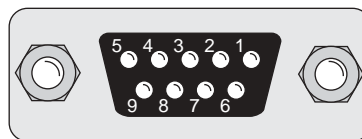


Bild 6.10.2.c Resolver cable



6.10.3 Encoder Interface Channel 2 (X3B)

Fig. 6.10.3 Encoder interface channel 2 (X3B)



! Only when the inverter is switched off and the voltage supply is disconnected may the plug be pulled out or plugged in!

ec.10 Definition of the interface

Channel 2 can be equipped with different interfaces. To avoid the connection of a wrong encoder, the installed interface is indicated in ec.10.

Incremental encoder input

In synchronous operation the second incremental encoder serves as input of the master drive. A second position encoder can be connected for positioning operation.

Signal	X3B	Description
U_{var}	5	Supply voltage for encoder (see 6.10.2)
+5,2 V	4	Supply voltage for encoder (see 6.10.2)
0 V	9	Reference potential
A	1	Signal input A
\bar{A}	6	Signal input A inverted
B	2	Signal input B
\bar{B}	7	Signal input B inverted
N	3	Reference marking input N
\bar{N}	8	Reference marking input N inverted
Shield	Housing	Shielding

The signal inputs of the second encoder interface support **only rectangular signals**.

Following specifications apply to the encoder interface 2 (X3B):

- max. operating frequency of input $f_G = 300$ kHz
- internal terminating resistor $R_t = 150 \Omega$
- 2...5 V high level at rectangular signals

Incremental encoder output

The incremental encoder output gives out the signals recorded at the encoder interface 1:1 in RS422-specification over the second channel (e.g. master drive in synchronous operation).

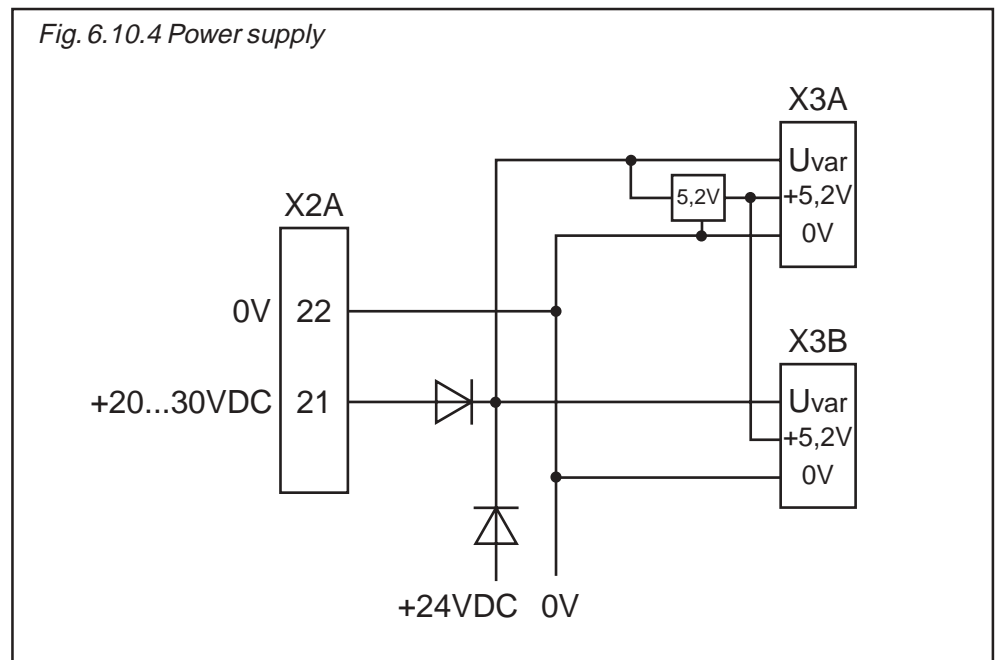
Signal	X3B	Description
U_{var}	5	Supply voltage for encoder (see 6.10.2)
+5,2 V	4	Supply voltage for encoder (see 6.10.2)
0 V	9	Reference potential
A	1	Signal output A
\bar{A}	6	Signal output A inverted
B	2	Signal output B
\bar{B}	7	Signal output B inverted
N	3	Reference marking output N
\bar{N}	8	Reference marking output N inverted
Shield	Housing	Shielding

Operating mode encoder 2 (ec.20)

With parameter ec.20 it is defined whether the encoder channel 2 shall work as input or output. Precondition for that is a built-in switch-selectable encoder interface (In.5 = 7).

ec.20	Function
0	Incremental encoder input
1	Incremental encoder output

6.10.4 Power Supply of Encoder



U_{var} U_{var} is an unstabilized voltage that is provided by the power stage of the KEB COMBIVERT. Dependent on the size of unit and the load, the voltage amounted to 15... 30 V DC. U_{var} is loadable at X3A and X3B with altogether 170 mA. If higher voltages / currents to supply the encoders are needed then the control must be supplied with an external voltage.

+5,2 V The +5 V voltage is a stabilized voltage and loadable at X3A and X3B with altogether 500 mA. Le +5 V provient de U_{var} , le courant disponible pour U_{var} décroît suivant la formule suivante:

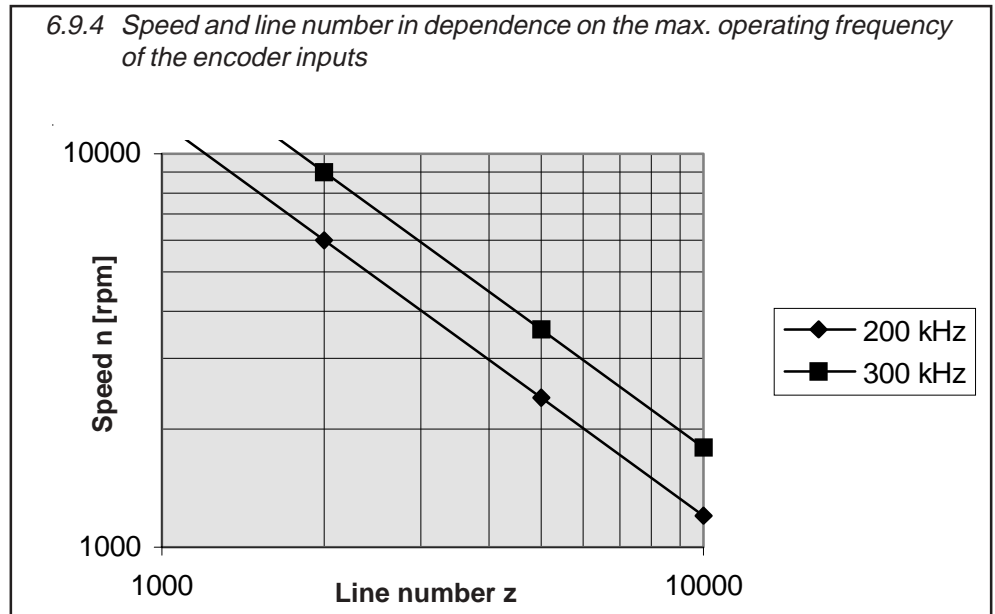
$$I_{var} = 170 \text{ mA} - \frac{5,2 \text{ V} \times I_{+5V}}{U_{var}}$$

6.10.5 Selection of Encoder

Precondition for a good control behaviour of a drive is not least a question of the selection and the correct connection of the encoder. This also includes the mechanical as well as the electrical connection.

Max. operating frequency (max. sampling frequency)

Depending on the max. operating frequency of the encoder input, the encoder and the maximum speed of the drive the line number of the encoder can be selected.



The max. signal frequency, which is given out by the encoder, is calculated as follows:

$$f_{\max} [\text{kHz}] = \frac{n_{\max} [\text{rpm}] \times z}{60000}$$

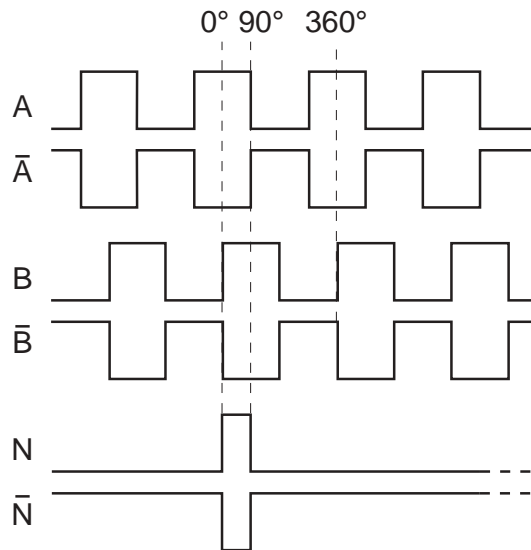
f_{\max} : max. signal frequency
 n_{\max} : max. speed
 z : encoder line number

The following condition must be met:

$$f_{\max} < \text{max. operating frequency of encoder} < \text{max. operating frequency of interface}$$

6.10.5.a Input signals

TTL-voltage differential levels according to TIA/EIA-RS422-B



The two, by 90° electrical out of phase signals, A and B as well as their inverted signals are generally evaluated. The zero track is needed for the reference point approach in the positioning module (F5-M/S). Zero track (also reference marking channel) gives out 1 signal per revolution.

Cable length

To achieve an unobjectionable function following cable lengths should not be exceeded. Precondition for it is that the supply voltage at the rotary encoder is within the specified tolerances.

The encoder lines should not be longer than 50 m. If longer cables are needed, please contact KEB.

Further information can be taken from the documentation of the respective manufacturer.

6.10.6 Basic Setting

Prior to start-up the inverter must be adapted to the encoder(s) which is/are used.

**Encoder interface 1 / 2
(Ec.0, Ec.10)**

Ec.0 displays the installed encoder interface 1; Ec.10 displays the installed encoder interface 2. The values correspond to following interfaces:

Value	Encoder interface
0	no Interface
1	Incremental encoder input TTL
2	Incremental encoder output 5 V
3	Incremental encoder input and output direct (not divisible by Ec.27; switchable with Ec.20)
4	Incremental encoder input and output TTL (switchable with Ec.20)
5	Initiator
6	SSI Interface
7	Resolver Interface
8	Tacho
9	Incremental encoder output TTL (from resolver over channel 2)
10	Incremental encoder output TTL
11	Hiperface
12	Incremental encoder input 24 V HTL
13	Incremental encoder input TTL with error detection
14	Sin/cos encoder input
15	Incremental encoder input 24 V HTL with error detection

In case of an invalid encoder identification the error „E.Hyb“ is indicated and the measured value in is displayed inverted in ec.0/ec.10.

On changing the encoder interface the error „E.HybC“ is indicated. By writing on parameter ec.0 or ec.10 the change is confirmed and the default values for the new interface are loaded.

Adjustment of encoder line number (Ec.1, Ec.11)

With this parameter the encoder line number is adjusted to the connected encoder within a range of 1...16383.

- ec.1 for encoder interface 1
- ec.11 for encoder interface 2

Speed sampling time (Ec.3, Ec.13)

This parameter defines the time over which the speed average is determined. At that the resolution of the speed detection is defined simultaneously.

ec.3 ec.13	Sampling time	Speed resolution with the use of an incremental encoder with 2500 pulses
0	0,5 ms	12 rpm
1	1 ms	6 rpm
2	2 ms	3 rpm
3	4 ms	1,5 rpm (Factory setting)
4	8 ms	0,75 rpm
5	16 ms	0,375 rpm
6	32 ms	0,1875 rpm
7	64 ms	0,09375 rpm
8	128 ms	0,046875 rpm
9	256 ms	0,0234375 rpm

When using other line numbers:

$$\text{Speed resolution} = \frac{\text{Specified speed resolution} \times 2500}{\text{Line number}}$$

**Encoder track change
(Ec.6, Ec.16)**

With Ec.6 bit 0...1 a rotation change for encoder input 1 and with Ec.16 a rotation change for encoder input 2 can be executed.

With Bit 4 (value 16) a system inverting can be activated. With the system inverting it is possible to run the motor with positive setting counter-clockwise at the shaft, without changing the hardware.

Following adjustments are possible:

Value	Function
	Direction of rotation
0	no change
1	inverted
2	depends on the sign of the actual frequency (initiator)
3	depends on track B (initiator terminal 4)
4-16	reserved
	Encoder system
0	no change
16	inverted

**Multiple evaluation
(Ec.7, Ec.17)**

Value	Evaluation of the encoder signals
0	Single (for initiator: evaluation of positive edges only) (2^0)
1	2-fold (for initiator: evaluation of positive and negative edge) (2^1)
2	4-fold (for incremental encoder) (2^2) default
3	8-fold (2^3)
4	16-fold (2^4)
5	32-fold (2^5)
6	64-fold (2^6)
...	
13	8192-fold (2^{13})

**Gear factor
(Ec.4; Ec.5, Ec.14, Ec.15)**

Through the gear factors it is possible to evaluate incremental encoders, which are not directly mounted onto the motor shaft. The parameters Ec.4 and Ec.5 adjust the gear factor for encoder channel 1, Ec.14 and Ec.15 for encoder channel 2. The gear factors are defined as follows:

$$\text{Gear factor} = \frac{\text{Motor speed}}{\text{Gear speed}}$$

$$\text{Gear factor 1} = \frac{\text{Ec.4 gear factor numerator 1}}{\text{Ec.5 gear factor denominator 1}} = \frac{-10000...10000}{1...10000}$$

$$\text{Gear factor 2} = \frac{\text{Ec.14 gear factor numerator 2}}{\text{Ec.15 gear factor denominator 2}} = \frac{-10000...10000}{1...10000}$$

As additional function it is possible to trigger one of the two numerators with the function „Analog parameter setting“ (see Chapter 6.9.10).

Simulation mode (Ec.27) With this parameter an encoder simulation can be adjusted.

Bit	Value	Function
0..1	0	Acceptance of the values from channel 1
	1	from channel 2
	2	from current actual value
2..3	0	Number of increments to be output (at Bit 0..1 = 2)
	4	
	8	
	12	
4..5	0	Divisor
	16	
	32	
	4	

Ec.27 adjusts the mode of the simulation channel. If channel 2 is adjusted with Ec.20 to incremental encoder output, then the mode in CH2 becomes effective with Ec.27 (Ec.27 source => CH2 useless). Otherwise the adjustments refer to a third pure simulation channel (e.g. channel 2 15-poles).



When adjusting Ec.27 Bit 0...1 = actual value, then channel 2 may not be occupied, since the internal encoder counter is used for the generation of the zero signal.

**Absolute position channel 1/2
(Ec.2 / Ec.12)**

(only F5-S)

These parameter exists only at F5-S. The system position of the attached resolver system is adjusted (factory setting).

With this parameter it is possible to adjust the controller to a not aligned motor. If the system position of the motor is unknown an automatic trimming can carried out. Before starting with the adjustment, the direction of rotation must be checked. The speed display (ru.9) must be positive in the case of clockwise rotation by hand. If that is not the case, the direction of rotation can be exchanged with Ec.6 as described.

- enter motor data
- the connected motor must be able to rotate freely
- open control release
- enter Ec.2/12 = 2206
- close control release

The motor is excited now with its rated current.

If the direction of rotation of the connected motor is not correct or two motor phases are exchanged, E.EnC is triggered.

For resolver systems the signal SIN+ and SIN- must be exchanged.

If the system position displayed in Ec.2/12 no longer changes the alignment is completed.

- open control release

If motors with aligned encoder systems are used, the value determined by the automatic alignment can be entered directly in Ec.2/12.



In order to replace S4-systems by F5-S the following calculation must be carried out:

- ec.7 (S4) * Pole pair number
- Furthermore pay attention to the encoder cable -
- The lower 16 Bit of the result must be entered in Ec.2/12 -

6.10.7 Additional Parameters

The following parameters are needed only for specific encoder interfaces and are explained more closely in the appropriate documentation.

SSI Multiturn resolution (Ec.21)

If an SSI-multiturn-absolute value encoder is connected, the number of the bits for the multiturn-resolution can be adjusted here (12 Bit).

SSI Clock frequency select (Ec.22)

The clock frequency of the SSI-encoder is adjusted in Ec.22. Two clock frequencies are available 0 : 312,5 kHz or 1 : 156,25 kHz. The smaller clock frequency should only be adjusted for long cables or in case interferences occur.

SSI Data code (Ec.23)

The unit supports two data formats for the SSI-encoders:
0 : binary coded 1 : Gray code

Nominal tachometer speed (Ec.25)

As reference speed the max. tachometer speed is adjusted in Ec.25.

Position Channel 1 (Ec.31) Position Channel 2 (Ec.32)

Ec.31 and Ec.32 show the position values of channel 1 and 2 after the gearbox. With a HARDWARE-RESET at the absolute value encoder only the positions after decimal point are reset. In order to display the new absolute position in parameter ec.31/32 a RESET of ec.33/34 must take place.

System offset Channel 1 (Ec.33)

Formula : ec.33/34 = position value- reference point (ps17)
 ru.54 = reference point (ps.17)

System offset Channel 2 (Ec.34)

By writing on this parameter the systems offset is reset. The actual position (ru.54) is automatically recalculated, except for ps.14 bit0..1 = 3 the mode Store Position Value is selected.

Formula: actual position (ru.54) = position value - system offset (ec.33/34)

Encoder 1 Typ (Ec.36)

Ec.36 indicates the type of the first encoder interface.

Encoder 1 Status (Ec.37)

Ec.37 indicates the status of the Hiperface.

Encoder 1 r/w (Ec.38)

Ec.38 adjusts the performance of the Hiperface.

6.10.8 Used Parameters

Parameter	Addr.							[?]	Notes
Ec.0 encoder 1 interface	1000	x	-	x	-127	127	1	GBK	- GBK=encoder Id
Ec.1 encoder 1 (inc/r)	1001	x	-	-	1	16383	1	GBK	- GBK=encoder Id
Ec.2 Absolute position 1	1002	ja	-	-	0	65535	1	0	- only F5-S
Ec.3 time 1 for speed calc.	1003	x	-	-	0	9	1	3	- -
Ec.4 gear 1 numerator	1004	x	-	-	-10000	10000	1	1000	- -
Ec.5 gear 1 determinant	1005	x	-	-	1	10000	1	1000	- -
Ec.6 enc.1 rotation	1006	x	-	-	0	23	1	0	- -
Ec.7 enc.1 trigger	1007	x	-	-	0	13	1	GBK	- GBK=encoder Id
Ec.10 encoder 2 interface	100A	x	-	x	-127	127	1	GBK	- GBK=encoder Id
Ec.11 encoder 2 (inc/r)	100B	x	-	-	1	16383	1	GBK	- GBK=encoder Id
Ec.12 Absolute position 2	100C	ja	-	-	0	65535	1	0	- only F5-S
Ec.13 time 2 for speed calc.	100D	x	-	-	0	9	1	3	- -
Ec.14 gear 2 numerator	100E	x	-	-	-10000	10000	1	1000	- -
Ec.15 gear 2 determinant	100F	x	-	-	1	10000	1	1000	- -
Ec.16 enc.2 rotation	1010	x	-	-	0	23	1	0	- -
Ec.17 enc.2 trigger	1011	x	-	-	0	13	1	2	- GBK=encoder Id
Ec.20 enc.2 operating mode	1014	x	-	-	0	1	1	GBK	- -
Ec.21 SSI multiturn resolution	1015	x	-	-	0	13	12	1	- -
Ec.22 SSI clock frq. sel.	1016	x	-	-	0	1	0	1	- -
Ec.23 SSI data code	1017	x	-	-	0	1	1	1	- -
Ec.25 nominal tacho speed	1019	x	-	-	1	16000	1500	1	rpm -
Ec.27 operation mode output	101B	x	-	x	0	47	1	0	- -
Ec.31 Absolute position channel 1	101F	-	-	-	0	255	1	0	- -
Ec.32 Absolute position channel 2	1020	-	-	-	0	255	1	0	- -
Ec.33 System offset channel 1	1021	ja	-	ja	-2 ³¹	2 ³¹ -1	1	0	Ink only F5-M/S
Ec.34 System offset channel 2	1022	ja	-	ja	-2 ³¹	2 ³¹ -1	1	0	Ink only F5-M/S
Ec.36 encoder 1 typ	1024	-	-	-	0	255	1	0	- -
Ec.37 encoder 1 state	1025	-	-	-	0	255	1	0	- -
Ec.38 encoder 1 r/w	1026	-	-	-	0	2	1	0	- -

- 1. Introduction
- 2. Summary
- 3. Hardware
- 4. Operation
- 5. Parameter
- 6. Functions**
- 7. Start-up
- 8. Special Operation
- 9. Error Assistance
- 10. Project Planning
- 11. Networks
- 12. Annex

- 6.1 Operating and Appliance Date
- 6.2 Analog In- and Outputs
- 6.3 Digital In- and Outputs
- 6.4 Set Value and Ramp Adjustment
- 6.5 Voltage-/Frequency Characteristic (U/f) Adjustment
- 6.6 Motor Data Adjustment
- 6.7 Protective Functions
- 6.8 Parameter Sets
- 6.9 Special Functions
- 6.10 Encoder Interface
- 6.11 SMM**
- 6.12 Technology Control
- 6.13 CP-Parameter Definition

- 6.11.1 Torque Compensation 3
- 6.11.2 Speed Control 4
- 6.11.3 Used Parameters 6

Chapter 6	Section 11	Page 2	Date 05.02.02	Name: Basis KEB COMBIVERT F5-G / B	© KEB Antriebstechnik, 2002 All rights reserved
---------------------	----------------------	------------------	------------------	--	--

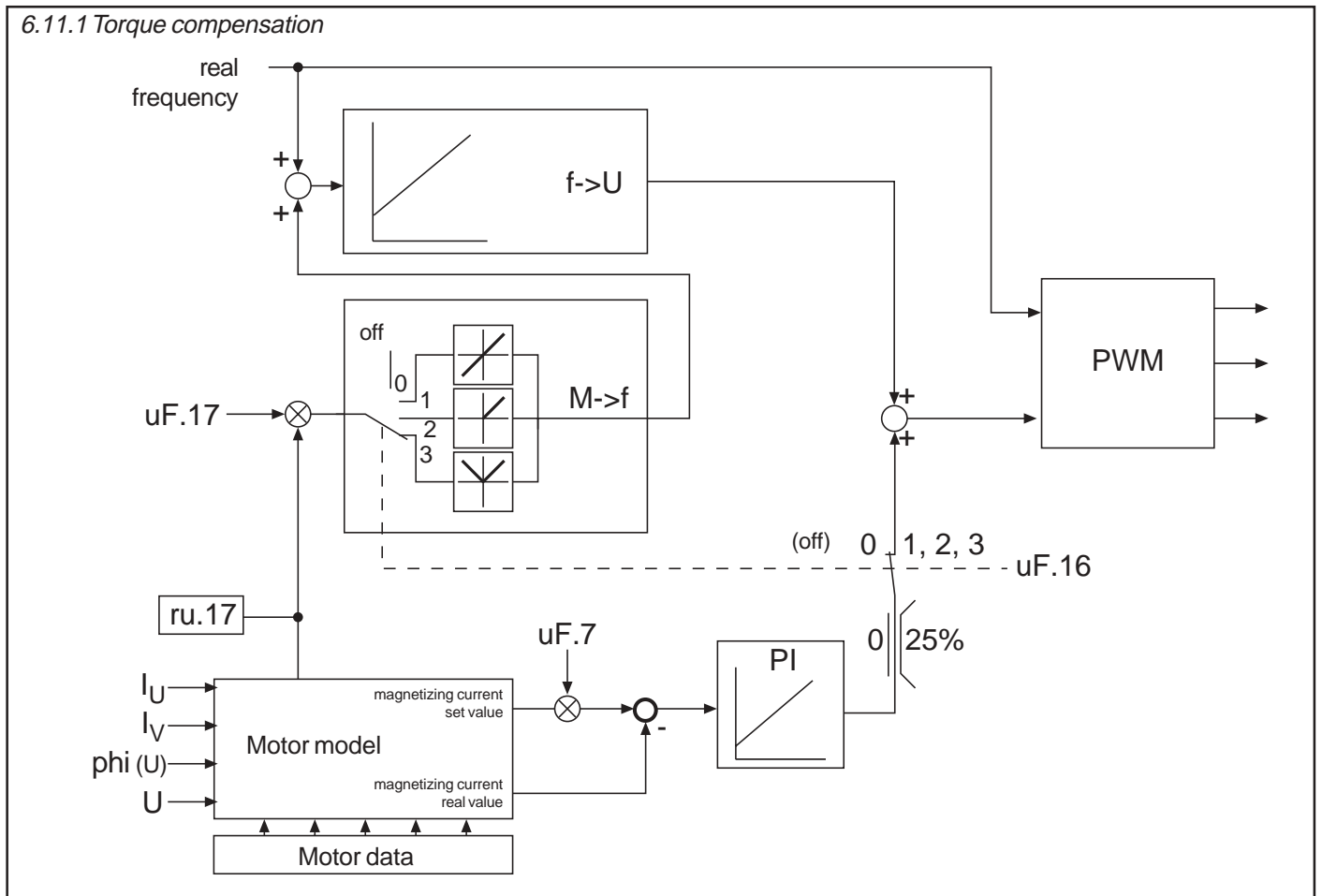
6.11 SSM

The SMM-function (sensorless motor management) includes the torque and slip compensation. Precondition for a good control characteristic is the input of the motor data in the dr-parameters (see Chapter 6.6).

6.11.1 Torque Compensation

Torque compensation adapts the voltage at variable load torques in such a way that the magnetizing current setpoint is kept constant. With it a higher maximum torque is achieved at small output frequencies compared to uncompensated operation. With uF.16 and uF.17 the torque compensation is activated and configured. The magnetizing current setpoint and actual value are calculated in the motor model. With uF.7 the magnetizing current setpoint can be adjusted to the application.

Attention! Through overcompensation increased motor currents can occur particularly with small frequencies.



Motordata The motor data is entered in the parameters dr.0...dr.6 as described in Chapter 6.6.

Energy saving factor (uF.7) In the case of activated torque compensation this parameter is used for the optimization of the magnetizing current setpoint to the application. If a drive operates for a long time in the partial-load range the motor heating and the energy consumption can be reduced by decreasing this factor. The energy saving function is switched off at activated torque compensation.

Torque compensation/ configuration (uF.16)

Parameter uF.16 defines the basic controller structure.

Dec.	Meaning
0	Torque compensation off
1	Torque compensation acts motoric and generatoric
2	Torque compensation works only in the motoric operation; resulting in a smoother run in the generatoric operation.
3	Torque compensation in motoric operation; overcompensation in the generatoric operation; resulting in a higher maximum torque and increased current in the generatoric operation compared to 1 and 2; because of the higher motor-own losses a braking resistor is only necessary at higher energy recovery compared to 0, 1 and 2.

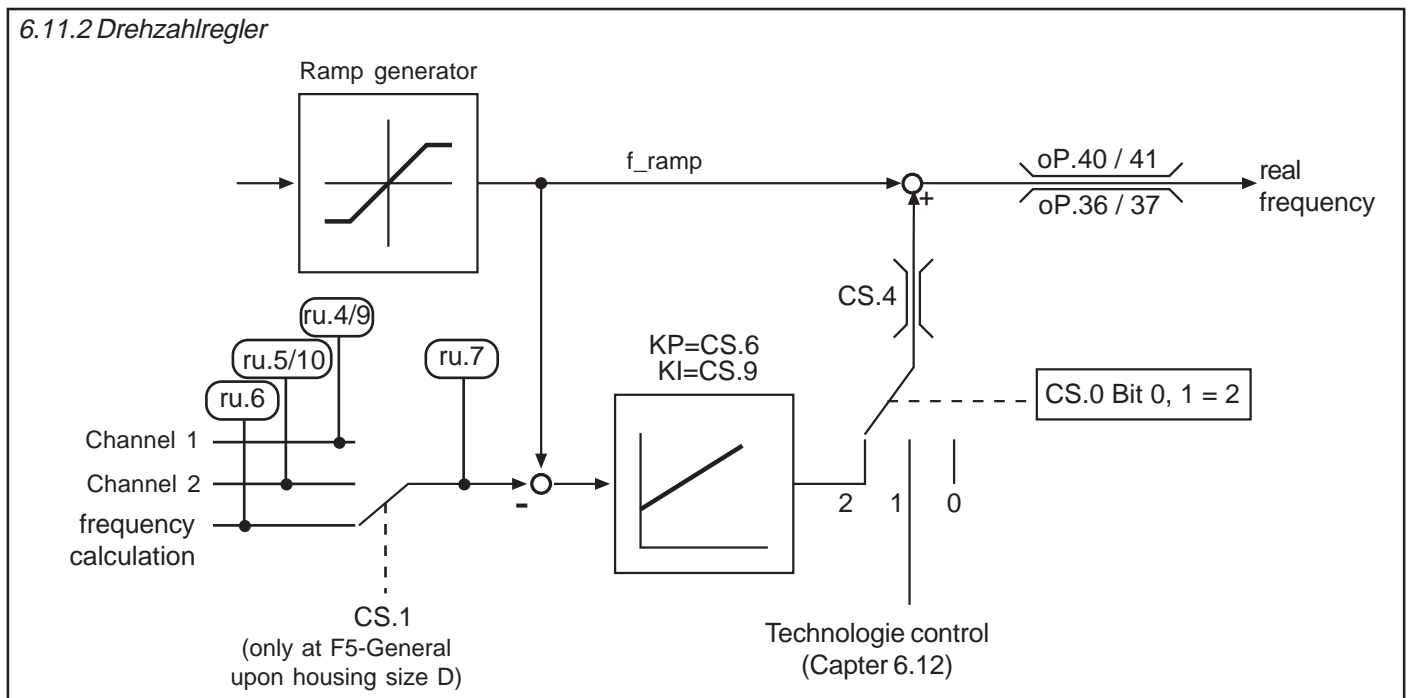
Torque compensation / amplification (uF.17)

With uF.17 the amplification is adjusted within the range of 0.00...2.50.

6.11.2 Speed Control

The integrated speed controller is used at cS.0 = „2“ for the slip compensation. Slip compensation compensates the speed changes caused through load changes by increasing/decreasing the output frequency (ru.3). With that a higher speed stability is achieved.

If one determines during operation that the drive constantly overcompensates, it can be balanced by a slight increase of the rated speed.



Configuration speed controller (cS.0)

Bit	Value	Description
0,1	0	Speed controller off
	1	Process control via technologie controller
	2	Slip compensation
	3	reserved
2	0	No function
3	0	Change of direction of rotation via the controller not possible
	8	Change of direction of rotation via the controller possible
4	0	No controller intervention at f_setting = 0Hz
	16	Controller intervention at f_setting = 0Hz
5	0	No slip limiting
	32	Slip is limited to max. rated slip x dr.9

Actual value source (cS.1)
 - not at B-Control -

The parameter cS.1 determines the actual value source for the speed controller. Following selections are available:

Value	Actual value source
0	Actual value from encoder interface channel 1
1	Actual value from encoder interface channel 2
2	Actual value is calculated internally

Frequency limit Speed controller (cS.4)

The frequency limit defines the maximum controller intervention within the range of 0...200 Hz (dep. on ud.2).








KP-Drehzahl (cS.6)

KP-speed defines the proportional component of the speed controller within the range of 0...32767.

KI-Drehzahl (cS.9)

KI-speed defines the integral component of the speed controller within the range of 0...32767.

6.11.3 Used Parameters

Parameter	Addr.								[?]	Notes
uF 7 Energy saving factor	0507	X	X	–	0,0	130,0	0,1	70,0	%	–
uF16 Autoboot configuration	0510	X	X	–	0	3	1	0	–	–
uF17 Autoboot gain	0511	X	X	–	0,00	2,50	0,01	1,25	–	–
cS 0 Speed control configuration	0F00	X	X	–	0	63	1	0	–	–
cS 1 Actual source	0F01	X	X	–	0	2	1	2	–	not at B housing
cS 4 Speed control frequency limit	0F04	X	X	–	0	200	0,0125	25	Hz	dep. on ud.2
cS 6 KP-speed	0F06	X	X	–	0	32767	1	50	–	–
cS.9 KI-speed	0F09	X	X	–	0	32767	1	500	–	–

1. Introduction

2. Summary

3. Hardware

4. Operation

5. Parameter

6. Functions

7. Start-up

8. Special Operation

9. Error Assistance

10. Project Planning

11. Networks

12. Annex

6.1 Operating and Appliance Date

6.2 Analog In- and Outputs

6.3 Digital In- and Outputs

6.4 Set Value and Ramp Adjustment

6.5 Voltage-/Frequency Characteristic (U/f) Adjustment

6.6 Motor Data Adjustment

6.7 Protective Functions

6.8 Parameter Sets

6.9 Special Functions

6.10 Encoder Interface

6.11 SMM, Posi, Synchron

6.12 Technology Control

6.13 CP-Parameter Definition

6.12.1	The PID-Controller	3
6.12.2	PID Setpoint Value	5
6.12.3	PID Actual Value	6
6.12.4	Sample Applications	7
6.12.5	Used Parameters	10

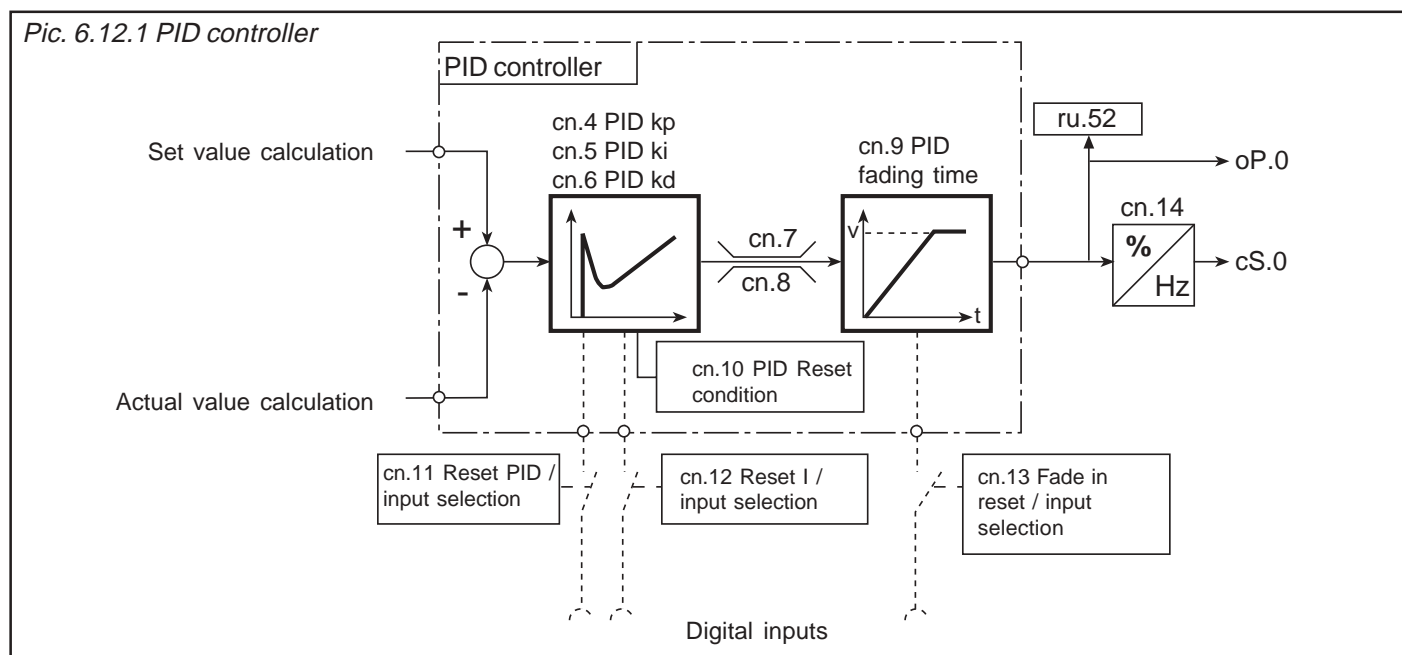
Chapter 6	Section 12	Page 2	Date 11.02.02	Name: Basis KEB COMBIVERT F5	© KEB Antriebstechnik, 2002 All rights reserved
---------------------	----------------------	------------------	------------------	--	--

6.12 Technology Controller

6.12.1 The PID Controller

The KEB COMBIVERT is equipped with a universally programmable technology controller, with its pressure, temperature or dancing position controls can be set up.

The technology controller consists of a set/actual value comparator, that puts the system deviation on a PID controller. With cn.4, 5 and 6 the P-, I- and D component is adjustable. The parameters cn.7 and cn.8 limit the maximum manipulated variable of the controller. With the PID-controller fade-in time (cn.9) the controller amplification can be driven up gently from 0...100%. Parameter cn.14 adjusts the frequency reach-through ins Hz/% (only F5-G/B). Over parameter cn.11, 12 and 13 the PID-Controller, the I-Controller and/or the controller fade-in can be reset. With cn.10 a PID-reset condition can be adjusted.



- PID controller KP (cn.4) Defines the proportional amplification factor in the range of 0,00...250,00.
- PID controller KI (cn.5) Defines the integral amplification factor in the range of 0,000...30,000.
- PID controller KD (cn.6) Defines the differential amplification factor in the range 0,000...250,00.
- PID positive limit (cn.7) The max. positive manipulated variable is determined with cn.7 in the range of -400,0...400,0 %, the max. negative manipulated variable is determined with cn.8 in the range of -400,0...400,0 %.
- PID fade-in time (cn.9) With it the control action during the start can be increased linear or decreased linear at the reset of the fade-in. The time refers of 100% of the controller output value. If one input is programmed for „Reset fade-in“ (cn.13) the fade-in is counted down at active input and counted up at inactive input.

Value range: -0,01; 0,00 ... 300 s; Resolution: 0,01 s

With the setting „-0.01“ the fade-in is calculated according to following formula:

$$\text{Fade-in factor} = f_setting (ru.2) / \text{max. setpoint value (o.P10/11)}$$

The function is only active, if the technology controller is used as process controller (cs.0 Bit 0...2 = 1). With the adjustment as setpoint controller the fade-in time is 0.

PID-Reset condition (cn.10) With cn.10 it is possible to set the reset conditions for the PID-Controller. Thus **simple** speed regulations can be realized for both directions of rotation.

cn.10	Function
0	PID-Controller is not reset
1	PID-Controller = 0 (is continuously reset)
2	PID-Controller is reset in case of modulation off

For speed regulations adjust the value „2“, with that the I-component of the controller is reset at LS or nOP. The value „1“ serves mainly for the start-up, to reset the controller manually.

Reset by way of digital inputs (cn.11...13) The whole controller, the I-component as well as the controller fade-in can be reset via a digital input. When resetting the masking the fade-in time is valid. For that purpose the decimal value of the corresponding inputs according to the table below has to be entered.

- cn.11 PID reset / input selection
- cn.12 I reset / input selection
- cn.13 Fade in reset / input selection

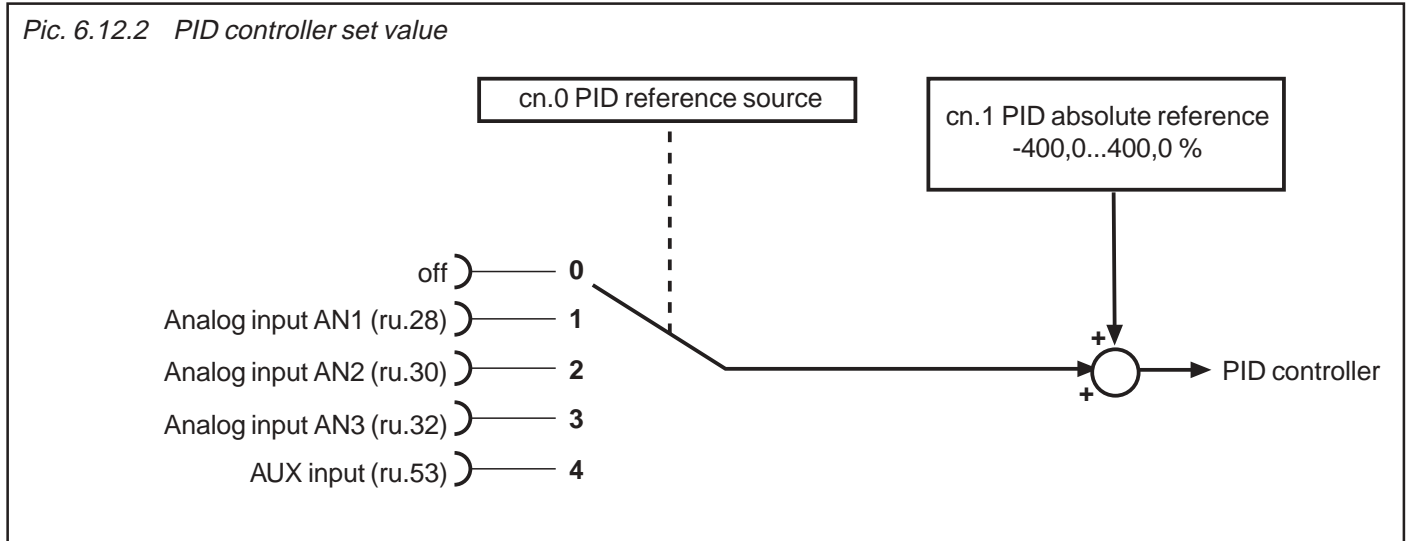
Bit -No.	Decimal value	Input	Terminal
0	1	ST (prog. input „control release / reset“)	X2A.16
1	2	RST (prog. input „reset“)	X2A.17
2	4	F (prog. input „forward“)	X2A.14
3	8	R (prog. input „reverse“)	X2A.15
4	16	I1 (prog. input 1)	X2A.10
5	32	I2 (prog. input 2)	X2A.11
6	64	I3 (prog. input 3)	X2A.12
7	128	I4 (prog. input 4)	X2A.13
8	256	IA (internal input A)	none
9	512	IB (internal input B)	none
10	1024	IC (internal input C)	none
11	2048	ID (internal input D)	none

PID Output frequency at 100% (cn.14) This block converts the percental controller output value into a frequency. The adjustment of cn.14 determines which frequency is output at 100 % controller output value. A frequency from 0.0...400.0 Hz (dep. on ud.2) can be adjusted. At cS.0 bit 0...1 = 1 the output value added with the ramp output frequency (ru.2) forms the output frequency (ru.3).
(only F5-G/B)

6.12.2 PID Setpoint Value

This section describes the PID-controller setpoint value. PID-setpoint value is composed of the absolute reference value (cn.1) and an additional setpoint source which is adjustable with cn.0. The two values are added up and transferred to the PID-controller setpoint input.

Pic. 6.12.2 PID controller set value



PID absolute reference (cn.1) With cn.1 the set value of the PID-Controller is preset digitally in the range of -400,0...400,0%. The parameter is set-programmable.

PID reference source (cn.0) Parameter cn.0 specifies the input which supplies the additional setpoint value. Following possibilities are selectable:

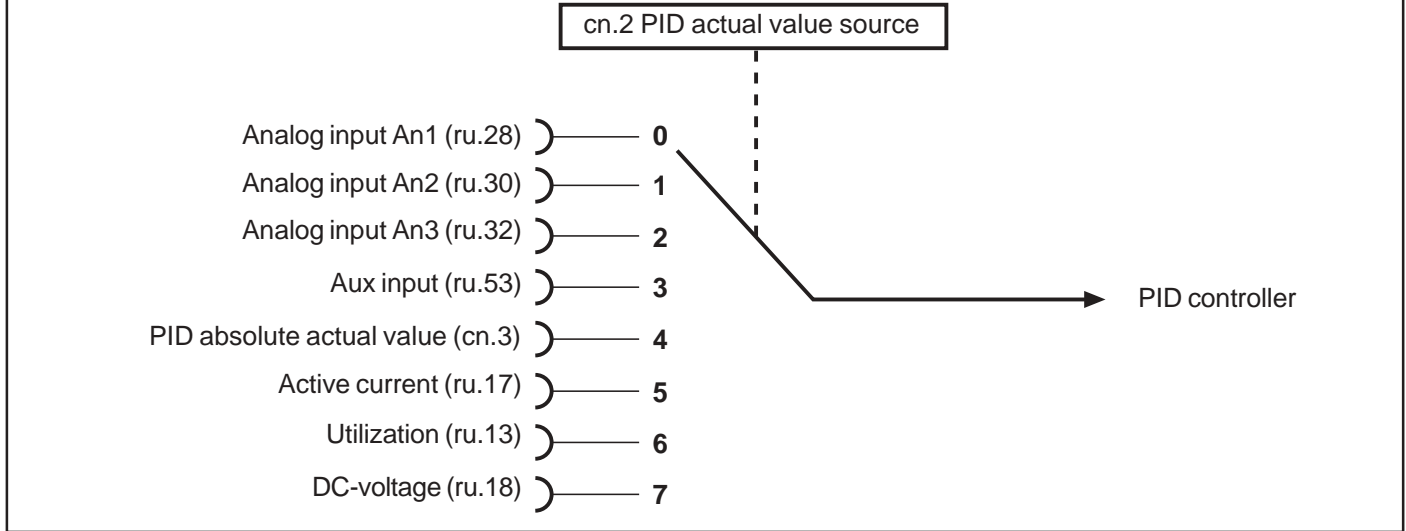
cn.0	PID reference source
0	off (default)
1	Analog input AN1 (ru.28)
2	Analog input AN2 (ru.30)
3	Analog input AN3 (ru.32)
4	Aux input (ru.53)

If one of the analog channels is adjusted, the signals can be individually adapted to the requirements with the analog amplifier, as described in Chapter 6.2.

6.12.3 PID Actual Value

This section describes the PID-controller actual value. The actual value input is adjusted with the PID-reference source (cn.2).

Pic. 6.12.3 PID controller actual value



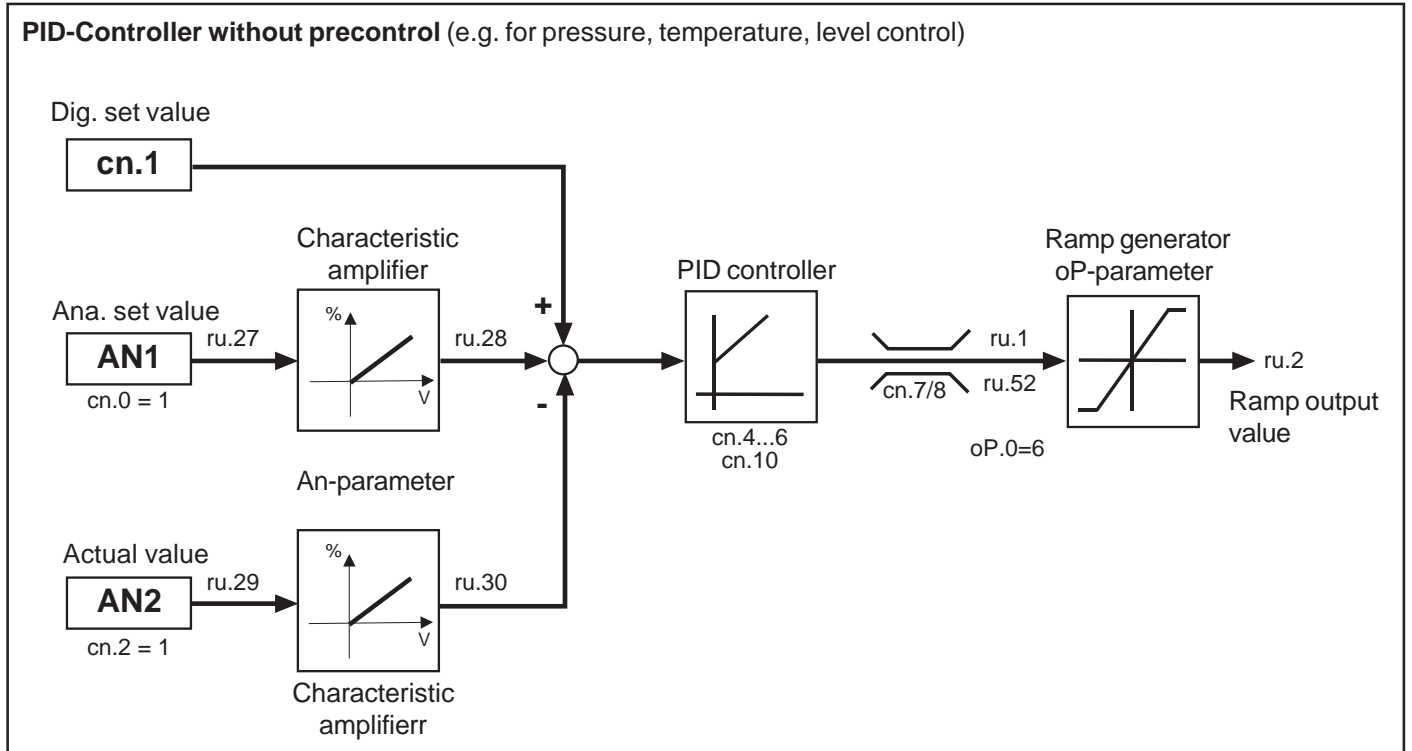
PID actual value source (cn.2) The actual value source (cn.2) determines from where the PID-Controller receives the actual value signal. Following signals are available:

cn.2	Signal	Function
0	AN1	Signal of the analog input 1 (see chapter 6.2)
1	AN2	Signal of the analog input 2 (see chapter 6.2) - reserved at B control -
2	AN3	Signal of the analog input 3 (see chapter 6.2) - reserved at B control -
3	Aux	Signal of the Aux input (see chapter 6.2)
4	cn.3	PID absolute actual value is preset with cn.3 in the range of -400,0...400,0 %
5	Active current	The active current -200...200 % displayed in parameter ru.17 is used as actual value signal (100 % = I_{rated})
6	Utilization	The utilization 0...255 % displayed in parameter ru.13 is used as actual value signal (100 % = 100 %)
7	DC-voltage	The DC-voltage 0...1000 V displayed in parameter ru.18 is used as actual value signal (100 % = 1000 V)

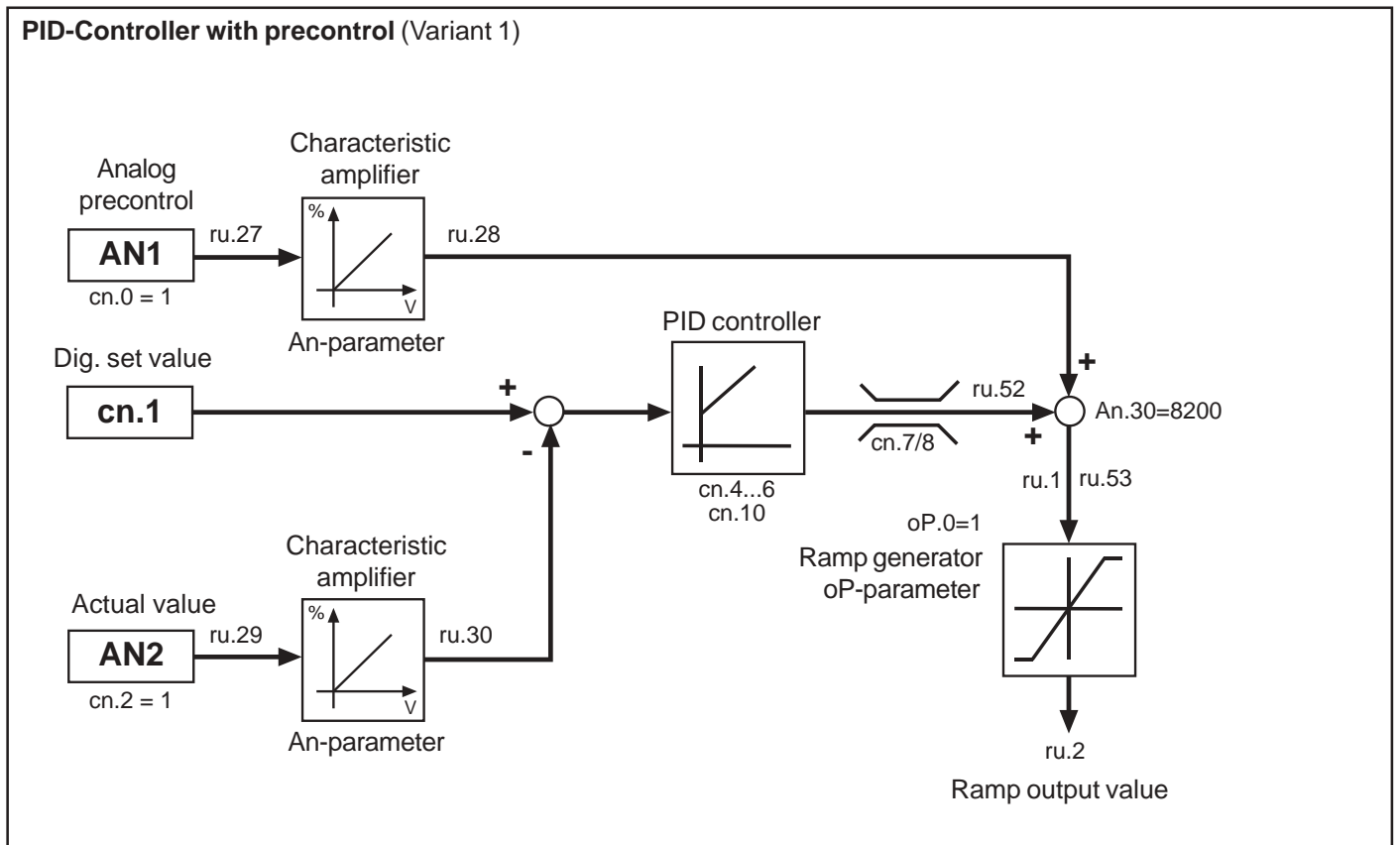
6.12.4 Sample Applications

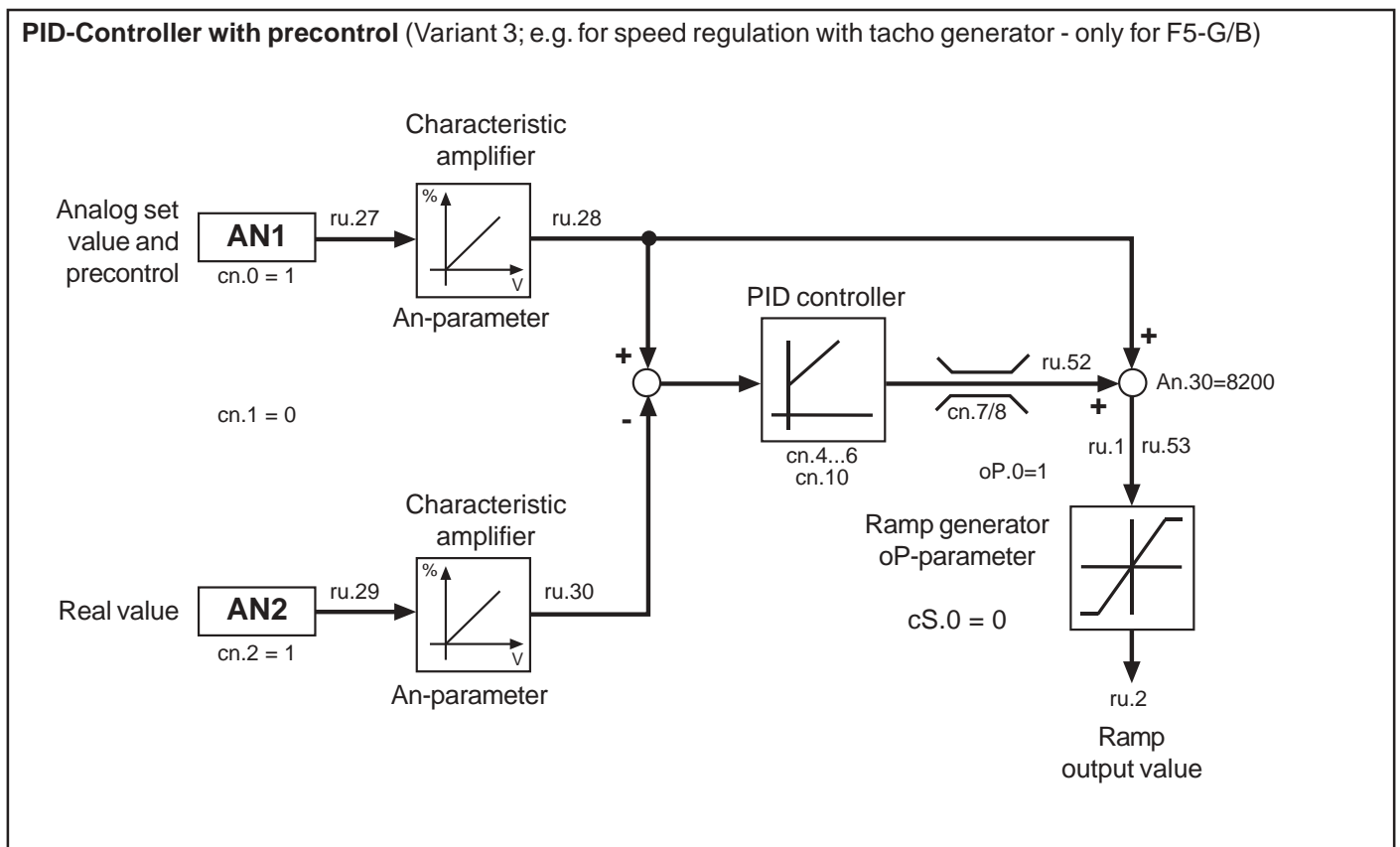
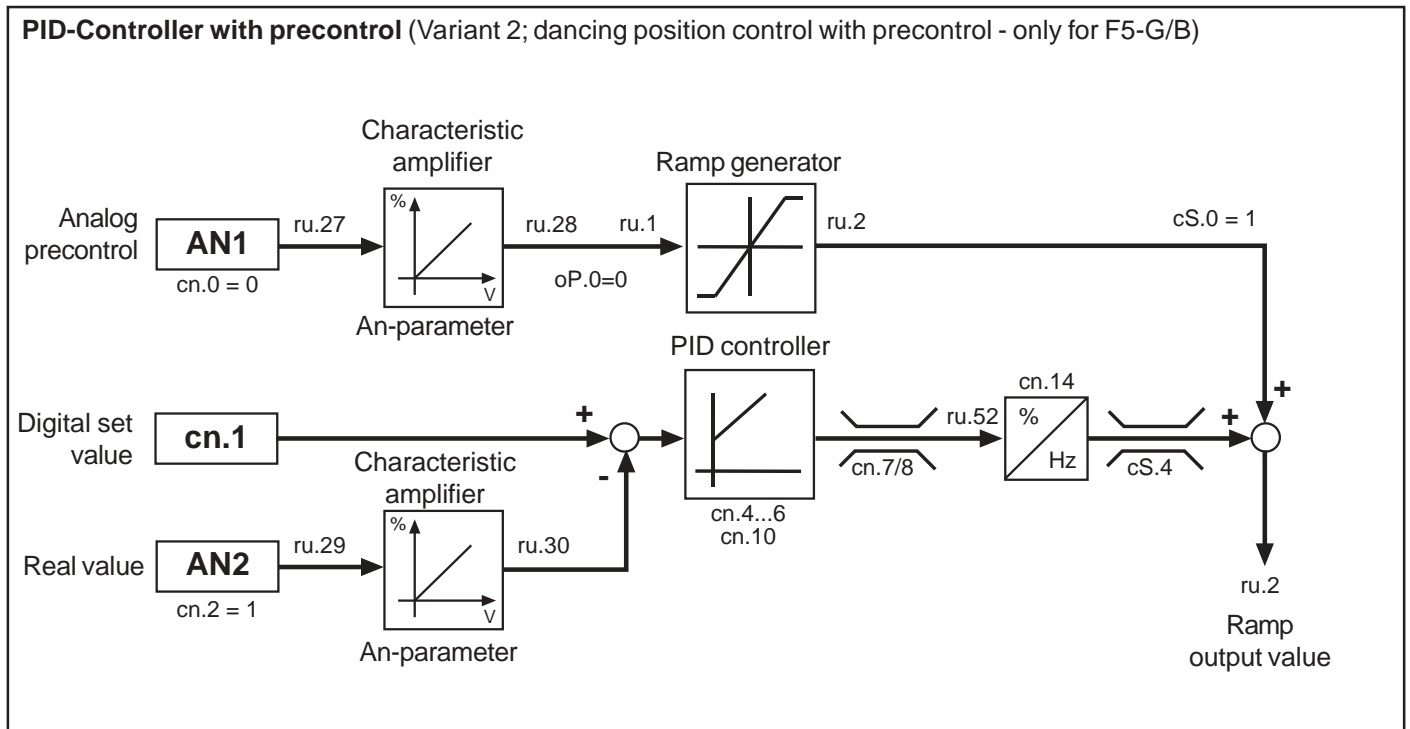
The following part describes some sample applications of the PID controller.

PID-Controller without precontrol (e.g. for pressure, temperature, level control)

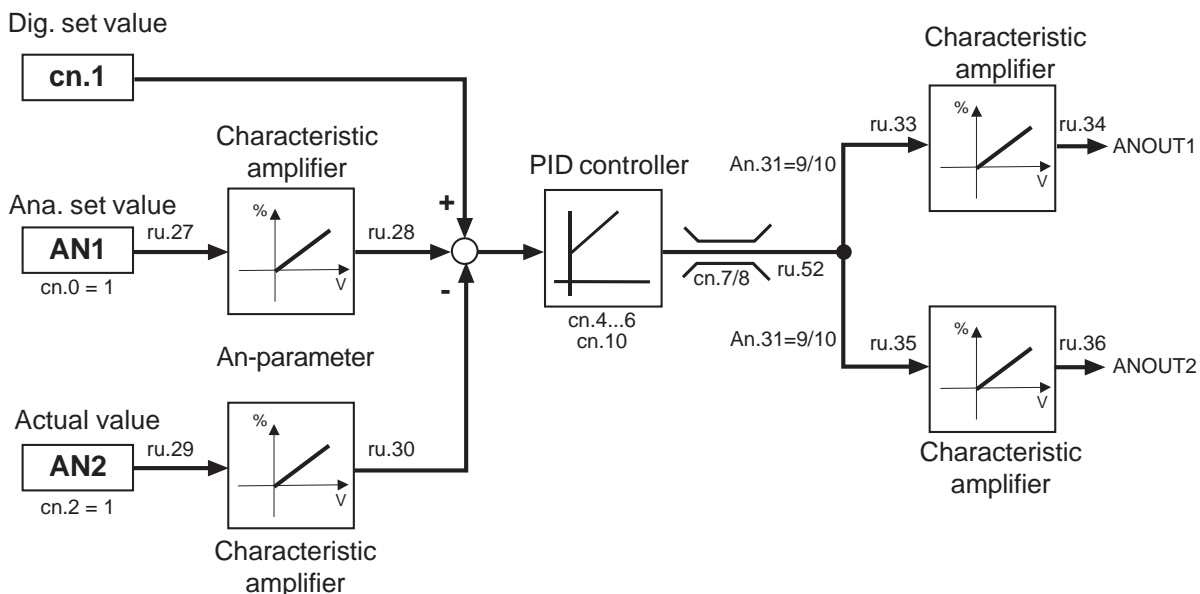


PID-Controller with precontrol (Variant 1)

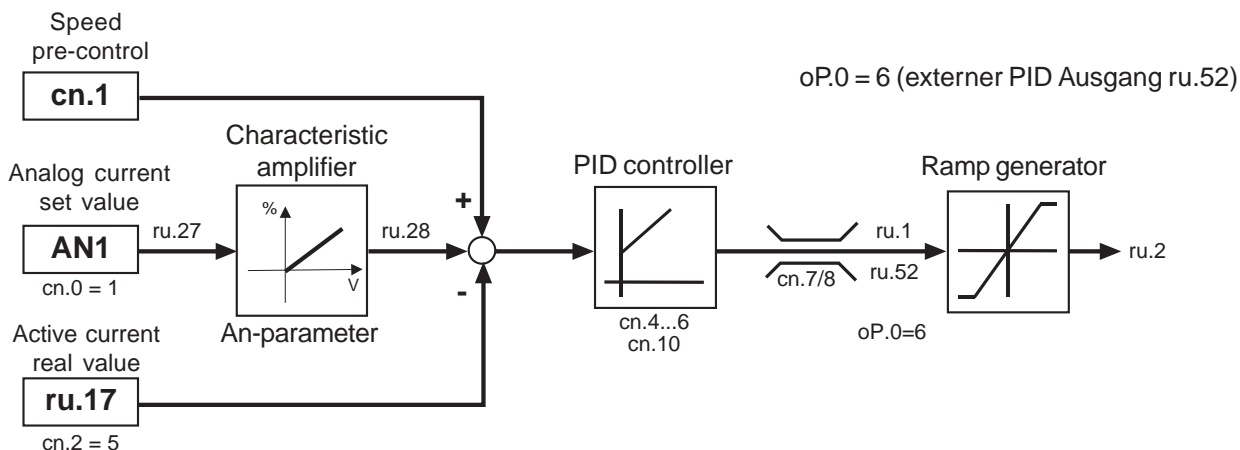




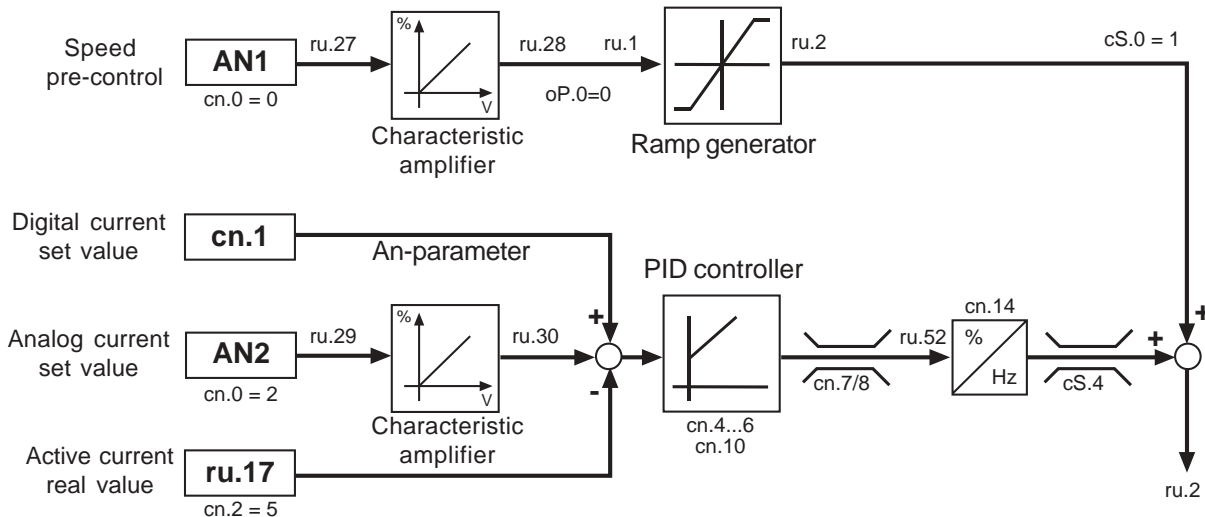
PID-Controller on the analog output



PID-Controller as active current- (torque-) regulation without precontrol



PID-Controller as active current- (torque-) regulation without precontrol



6.12.5 Used Parameters

Parameter	Addr.								[?]	Notes
cn 0 PID reference source	0700	X	X	-	0	4	1	0	-	-
cn 1 PID abs. reference	0701	X	X	-	-400,0	400,0	0,1	0,0	%	-
cn 2 PID act. value source	0702	X	X	-	0	7	1	0	-	-
cn 3 PID abs. act. value	0703	X	-	-	-400,0	400,0	0,1	0,0	%	-
cn 4 PID kp	0704	X	X	-	0,00	250,00	0,01	0,00	-	-
cn 5 PID ki	0705	X	X	-	0,000	30,000	0,001	0,000	-	-
cn 6 PID kd	0706	X	X	-	0,00	250,00	0,01	0,00	-	-
cn 7 PID pos. limit	0707	X	X	-	-400,0	400,0	0,1	400,0	%	-
cn 8 PID neg. limit	0708	X	X	-	-400,0	400,0	0,1	-400,0	%	-
cn 9 PID fading time	0709	X	X	-	-0,01	300,00	0,01	0,00	s	-0,01 freq. dependend
cn10 PID reset condition	070A	X	X	-	0	2	1	0	-	-
cn11 PID reset inp. sel.	070B	X	-	X	0	4095	1	0	-	-
cn12 I reset inp. sel.	070C	X	-	X	0	4095	1	0	-	-
cn13 fade in reset inp. sel.	070D	X	-	X	0	4095	1	0	-	-
cn14 PID out freq at 100%	070E	X	X	-	0	400	0,0125	0	Hz	dependend on ud.2
ru13 Actual utilization	020D	-	-	-	0	255	1	0	%	-
ru17 Active current	0211	-	-	-	-3276,7	3276,7	0,1	0	A	-
ru18 Actual DC voltage	0212	-	-	-	0	1000	1	0	V	-
ru28 AN1 post amplifier display	021C	-	-	-	-400,0	400,0	0,1	0	%	-
ru30 AN2 post amplifier display	021E	-	-	-	-400,0	400,0	0,1	0	%	-
ru53 AUX display	0235	-	-	-	-400,0	400,0	0,1	0	%	-

1. Introduction

2. Summary

3. Hardware

4. Operation

5. Parameter

6. Functions

7. Start-up

8. Special Operation

9. Error Assistance

10. Project Planning

11. Networks

12. Annex

6.1 Operating and Appli-
Date

6.2 Analog In- and Outputs

6.3 Digital In- and Outputs

6.4 Set Value and Ramp
Adjustment

6.5 Voltage-/Frequency
Characteristic (U/f)
Adjustment

6.6 Motor Data Adjustment

6.7 Protective Functions

6.8 Parameter Sets

6.9 Special Functions

6.10 Encoder Interface

6.11 SMM, Posi, Synchron

6.12 Technology Control

6.13 CP-Parameter Definition

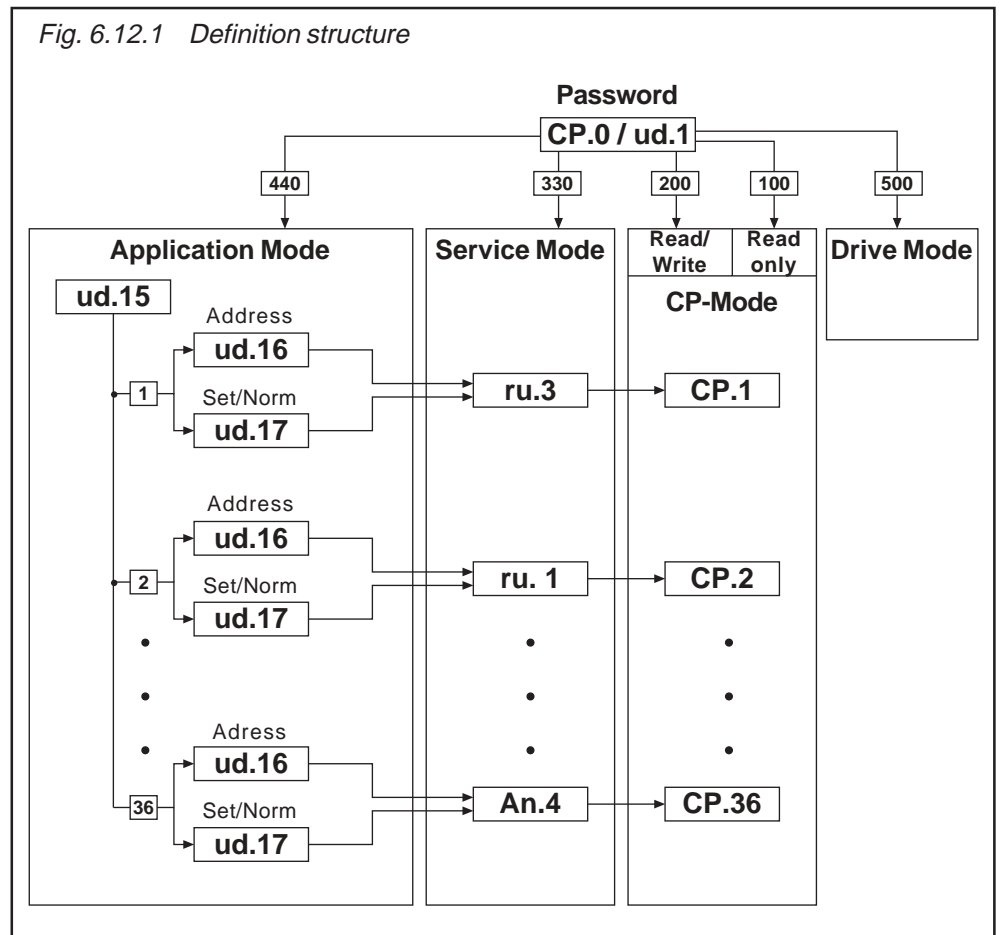
6.13.1	Survey	3
6.13.2	Assignment of CP-Parameters	4
6.13.3	Example	5
6.13.4	Display Standardization	6
6.13.5	Used Parameters	8

Chapter 6	Section 13	Page 2	Date 11.04.02	Name: Basis KEB COMBIVERT F5	© KEB Antriebstechnik, 2002 All rights reserved
---------------------	----------------------	------------------	------------------	--	--

6.13 CP-Parameter Definition

Once the development stage of a machine is completed, usually only a few parameters are required for the adjustment or the control of the inverter. To make the handling easier and the user documentation more understandable as well as to increase the safety of operation against unauthorized access, the possibility exists to create the own user surface with the CP-parameters. For that purpose 37 parameters (CP.0...CP.36) are available, 36 of them (CP.1...CP.36) are free for assignments.

6.13.1 Survey



With ud.15 the CP-parameter that is to be edited is determined. With ud.16 and ud.17 the CP-parameter is defined through its address and the respective set. Depending on the adjusted password (CP.0 or ud.1)

- the adjusted parameter is directly displayed in the Service Mode
- the adjusted parameter is displayed as CP-parameter in the CP-Mode

Parameter CP.0 is not programmable and always contains the password input. If the inverter is in the Application Mode or Service Mode ud.1 is used for the password input.

The parameters ud.15...17 as well as Fr.1 are not permitted as CP-parameter and are acknowledged as invalid parameter address. When entering an invalid parameter address the parameter is set to „oFF“ (-1). The appropriate CP-parameter is not displayed at this setting.

6.13.2 Assignment of CP-Parameters

CP selector (ud.15) With ud.15 the CP-parameter to be programmed is adjusted in the range of 1...36. CP.0 is not adjustable.

CP address (ud.16) ud.16 determine the parameter address (see Chapter 5) of the parameter to be displayed:

ud.16	
-1:	Parameter not used
0...32767:	Parameter address

Invalid or not exists parameter addresses are ignored with „Data invalid“.

CP set norm (ud.17) ud.17 determine the set, the addressing and the standardization of the parameter to be displayed. The parameter is bit-coded. The individual bits are decoded as follows:

Determination of parameter set for indirect set addressing

Bit 0...7 determines the set selection for direct set programming, i.e. all selected sets contain the same value, which is defined by the CP-parameter. If direct set programming (bit 8, 9) is selected at least one set must be selected as otherwise an error message is triggered in the cp mode.

Bit								Value	Set
7	6	5	4	3	2	1	0		
0	0	0	0	0	0	0	0	0	none
0	0	0	0	0	0	0	1	1	0
0	0	0	0	0	0	1	0	2	1
0	0	0	0	0	0	1	1	3	0+1
...							
1	1	1	1	1	1	1	1	255	All

-> Data invalid, if Bit 8 and 9 = 0

Determination of set addressing mode

Bit 8 and 9 determine the set addressing mode:

Bit			
8	9	Value	Function
0	0	0	Direct set addressing; the sets determined by Bit 0...7 are valid
0	1	256	Current set; the current set is displayed / edited
1	0	512	Indirect set addressing, the parameter set determined with the set pointer Fr.9 is displayed / edited
1	1	768	free

Display standardization

Bit 10...12 determine how the defined parameter value is displayed. Up to seven different user standardizations (see further on in this chapter) can be determined with the parameters ud.18...21.

Bit				
12	11	10	Value	Function
0	0	0	0	Use standard standardization of the parameter
0	0	1	1024	Display standardization from set 1
0	1	0	2048	Display standardization from set 2
...			...	
1	1	1	7168	Display standardization from set 7

6.13.3 Example

As an example a user menu with the following features shall be programmed:

1. Display of current actual frequency (ru.3) in the respective set
2. Adjustment of a fixed frequency / fixed value (oP.21) in set 2
3. Adjustment of a fixed frequency /fixed value (oP.21) in set 3
4. Acceleration and deceleration time (oP.28/oP.30) for set 2 and 3
5. Energy saving factor (uF.7) shall be displayed in set 2 with display standardization 4

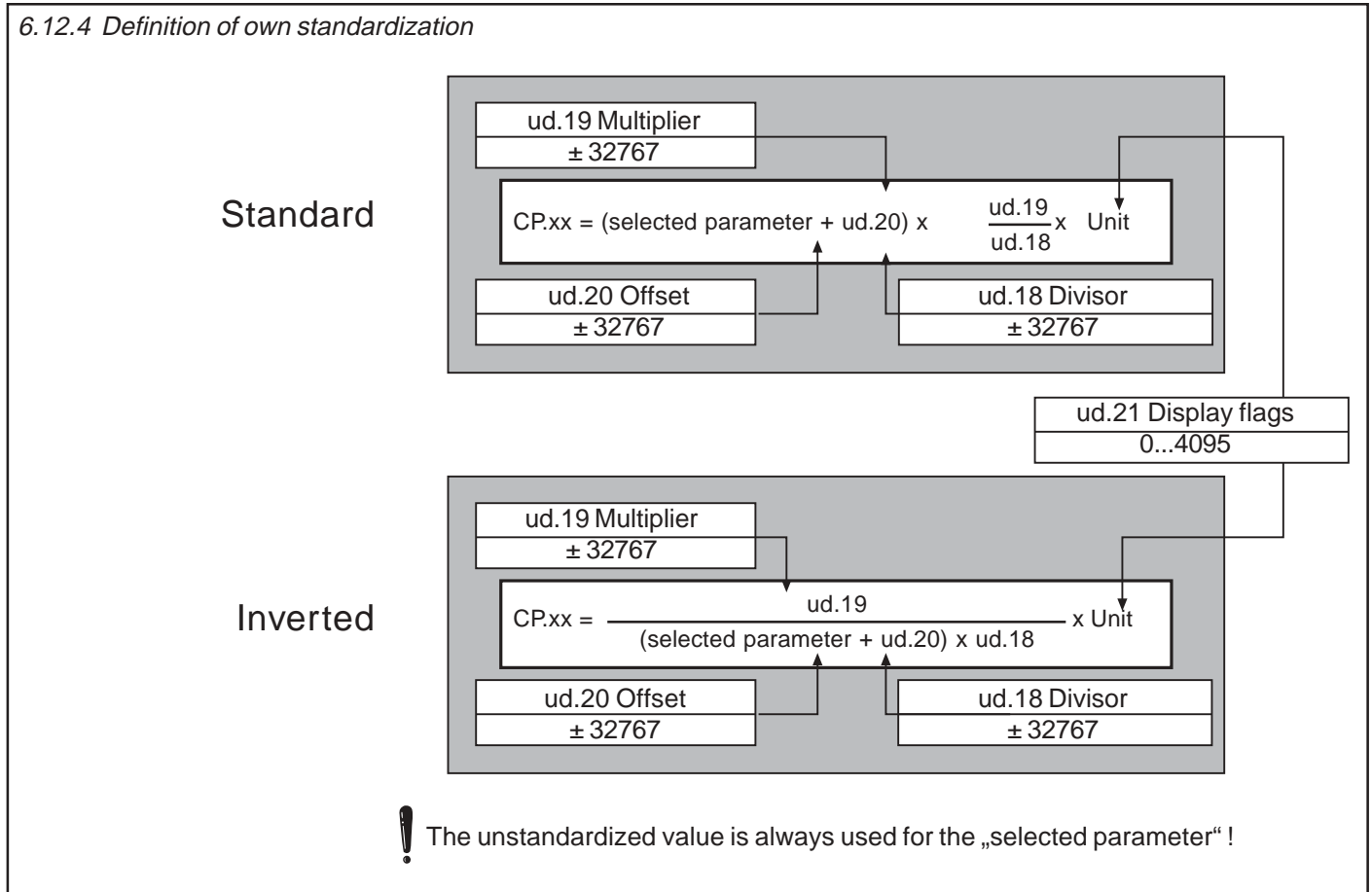
- 1.) ud.15 = 1 ; CP.1
ud.16 = 0203h ; Parameter address for ru.3
ud.17 = 256 ; Display in the active set
- 2.) ud.15 = 2 ; CP.2
ud.16 = 0315h ; Parameter address for oP.21
ud.17 = 4 ; Setting in set 2
- 3.) ud.15 = 3 ; CP.3
ud.16 = 0315h ; Parameter address for oP.21
ud.17 = 8 ; Setting in set 3
- 4.) ud.15 = 4 ; CP.4
ud.16 = 031Ch ; Parameter address for oP.28
ud.17 = 12 ; Setting in set 2 and 3
ud.15 = 5 ; CP.5
ud.16 = 031Eh ; Parameter address for oP.30
ud.17 = 12 ; Setting in set 2 and 3
- 5.) ud.15 = 6 ; CP.6
ud.16 = 0507h ; Parameter address for uF.7
ud.17 = 4097 ; Setting in set 0 and display standardization 4
- 6.) ud.15 = 7 ; CP.7
ud.16 = -1: off ; CP.7 not displayed
ud.17 = xxx ; ud.17 no function

Adjust all other parameter sets to „off“, so that no indication occurs.

The acceptance of the values takes place only after Power-On-Reset of the operator.

6.13.4 Display Standardization

The KEB COMBIVERT gives the user the possibility to define his own standardization (e.g. km/h or bottles/min) in the CP-Mode. The parameters ud.18...20 are used for conversion, ud.21 for specifying the method of calculation, the decimal places as well as the units indicated in KEB COMBIVIS.



ud.18 Display standardization Divisor Adjusts the divisor in the range of ±32767 (default 1). The parameter is set-programmable (not at B-control).

ud.19 Display standardization Multiplier Adjusts the multiplier in the range of ±32767 (default 1). The parameter is set-programmable (not at B-control).

ud.20 Display standardization Offset Adjusts the offset in the range of ±32767 (default 0). The parameter is set-programmable (not at B-control).

ud.21 Display standardization Mode With ud.21 the calculation mode, the decimal places as well as the units indicated in KEB COMBIVIS are adjusted. The parameter is bit-coded and set-programmable (not at B-control). It is adjustable in the range of 0...4095.

Bit 12...15	Bit 11...8	Bit 7...6	Bit 5...0	ud.21
-	-	-	see table 1	Unit
-	-	see table 2	-	Calculation mode
-	see table 3	-	-	Representation
free	-	-	-	-

Table 1 Unit

Value	Unit	Value	Unit	Value	Unit	Value	Unit
0	none	16	km/h	32	K	48	lbin
1	mm	17	1/min	33	mΩ	49	in/s
2	cm	18	Hz	34	Ω	50	ft/s
3	m	19	kHz	35	kΩ	51	ft/min
4	km	20	mV	36	INC	52	ft/s ²
5	g	21	V	37	%	53	ft/s ³
6	kg	22	kV	38	KWh	54	MPH
7	us	23	mW	39	mH	55	kp
8	ms	24	W	40	-	56	psi
9	s	25	kW	41	-	57	°F
10	h	26	VA	42	in	58	-
11	Nm	27	kVA	43	ft	59	-
12	kNm	28	mA	44	yd	60	-
13	m/s	29	A	45	oz	61	-
14	m/s ²	30	kA	46	lb	62	-
15	m/s ³	31	°C	47	lbft	63	-

Table 2
Calculation mode

Value	Function
0	(selected parameter + ud.20) x $\frac{ud.19}{ud.18} = CP.xx$
64	$\frac{ud.19}{(selected\ parameter + ud.20) \times ud.18} = CP.xx$
-	free
-	free

The unstandardized value is always used for the „selected parameter“ !

Table 3
Representation




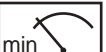




Value	Representation
0	0 decimal places
256	1 demical place
512	2 decimal places
768	3 decimal places
1024	4 decimal places
1280	variable decimal places
1536	Hexadecimal
-	free

Example The actual frequency shall be displayed in CP.1 in rpm. Display standardization from set 4.

ud.15 = 1 ; CP.1
 ud.16 = 0203h ; Actual frequency ru.3
 ud.17 = 4352 ; Display in current set, display standardization from set 4

Satz 4 ud.18 = 80 ; Conversion from 1/80 Hz into rpm without pole pair number
 Satz 4 ud.19 = 60
 Satz 4 ud.20 = 0 ; no Offset
 Satz 4 ud.21 = 17 ; Unit rpm; direct calculation mode; no decimal places

6.13.5 Used Parameters

Param.	Adr.	R/W 	PROG. 	ENTER 					
ud.1	0801h	✓	-	✓	0	9999	1	440	Application
ud.15	080Fh	✓	-	✓	1	36	1	1	-
ud.16	0810h	✓	-	✓	-1 (off)	32767 (7FFFh)	512 (0203h)	div.	dep. on ud.15
ud.17	0811h	✓	-	✓	0	8191	1	1	-
ud.18	0812h	✓	✓	✓	-32767	32767	1	1	not at B-control
ud.19	0813h	✓	✓	✓	-32767	32767	1	1	not at B-control
ud.20	0814h	✓	✓	✓	-32767	32767	1	0	not at B-control
ud.21	0815h	✓	✓	✓	0	1791	1	0	not at B-control

1. Introduction

2. Summary

3. Hardware

4. Operation

5. Parameter

6. Functions

7. Start-up

8. Special Operation

9. Error Assistance

10. Project Planning

11. Networks

12. Annex

7.1 Preparatory Measures

7.2 Initial Start-up

7.1.1 After uncasing the Goods 3

7.1.2 Installation and Connection 3

7.1.3 Checklist prior to Start-up 4

7. Start-up

7.1 Preparatory Measures

7.1.1 After unpacking the Goods

The following chapter is intended for everybody who has no experience with the KEB frequency inverters. It shall allow a correct entering into this field. But because of the complex application possibilities we must restrict ourselves to explaining the start-up of standard applications.

After unpacking the goods and checking them for complete delivery following measures are to be carried out:

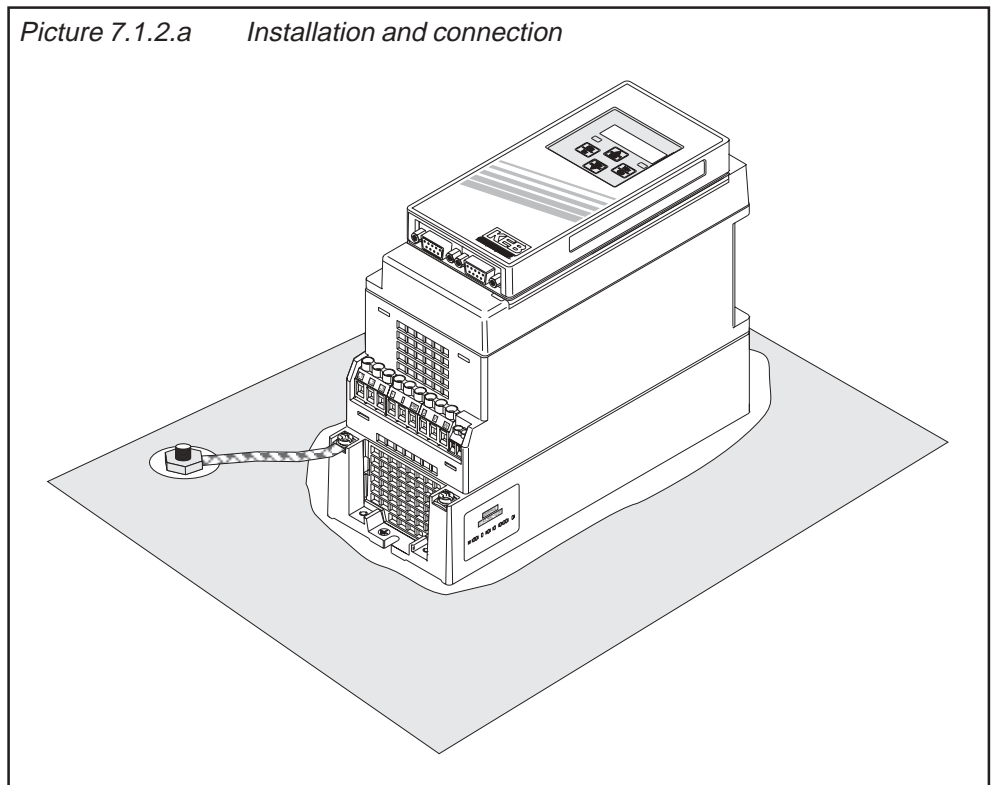
- Visual control for transport damage
Should any external damages to the KEB COMBIVERT be visible get in touch with your forwarding agent and return the unit with a corresponding report to KEB.
- Check the voltage class
Absolutely check before assembly whether the supply voltage of the KEB COMBIVERT matches the application.

7.1.2 Installation and Connection

The EMC-conform installation of the inverter is described in the Instruction Manual Part 1. Installation and connection instructions are found in the Instruction Manual Part 2.

- The mounting surface of the inverter must be bright.
- If necessary, use contact lacquer as protection against corrosion.
- Connect the earthing strip to central point in the control cabinet.

Picture 7.1.2.a Installation and connection



7.1.3 Checklist prior to Start-up

Before switching on the inverter go through the following checklist.

- Is the inverter firmly bolted in the control cabinet?
- Is there enough space to ensure sufficient air circulation?
- Are mains and motor cables as well as the control cables installed separately from each other?
- Are the inverters connected to the correct supply voltage?
- Are all mass and earthing cables attached and well contacted?
- Ensure that mains and motor cables are not interchanged as that will lead to the destruction of the inverter!
- Is the motor connected in-phase?
- Check tacho, initiator and encoder for firm attachment and correct connection!
- Check, whether all power and control cables are firmly in place!
- Remove any tools from the control cabinet!
- Attach all covers and protective caps to ensure that all live parts are secured against direct contact.
- When using measuring instruments or computers an isolating transformer should be used, if not, make sure that the equipotential bonding between the supply lines is guaranteed!
- Open the control release of the inverter to avoid the unintended starting of the machine.

1. Introduction

2. Summary

3. Hardware

4. Operation

5. Parameter

6. Functions

7. Start-up

8. Special Operation

9. Error Assistance

10. Project Planning

11. Networks

12. Annex

7.1 Preparatory Measures

7.2 Initial Start-up

7.2.1	Switching on of KEB COMBIVERT	3
7.2.2	Basic Settings in the CP-Mode	4
7.2.3	Set value selection	4
7.2.4	Testing of Drive	5

Chapter 7	Section 2	Page 2	Date 01.02.02	Name: Basis KEB COMBIVERT F5-G / B	© KEB Antriebstechnik, 2002 All Rights reserved
---------------------	---------------------	------------------	------------------	--	--

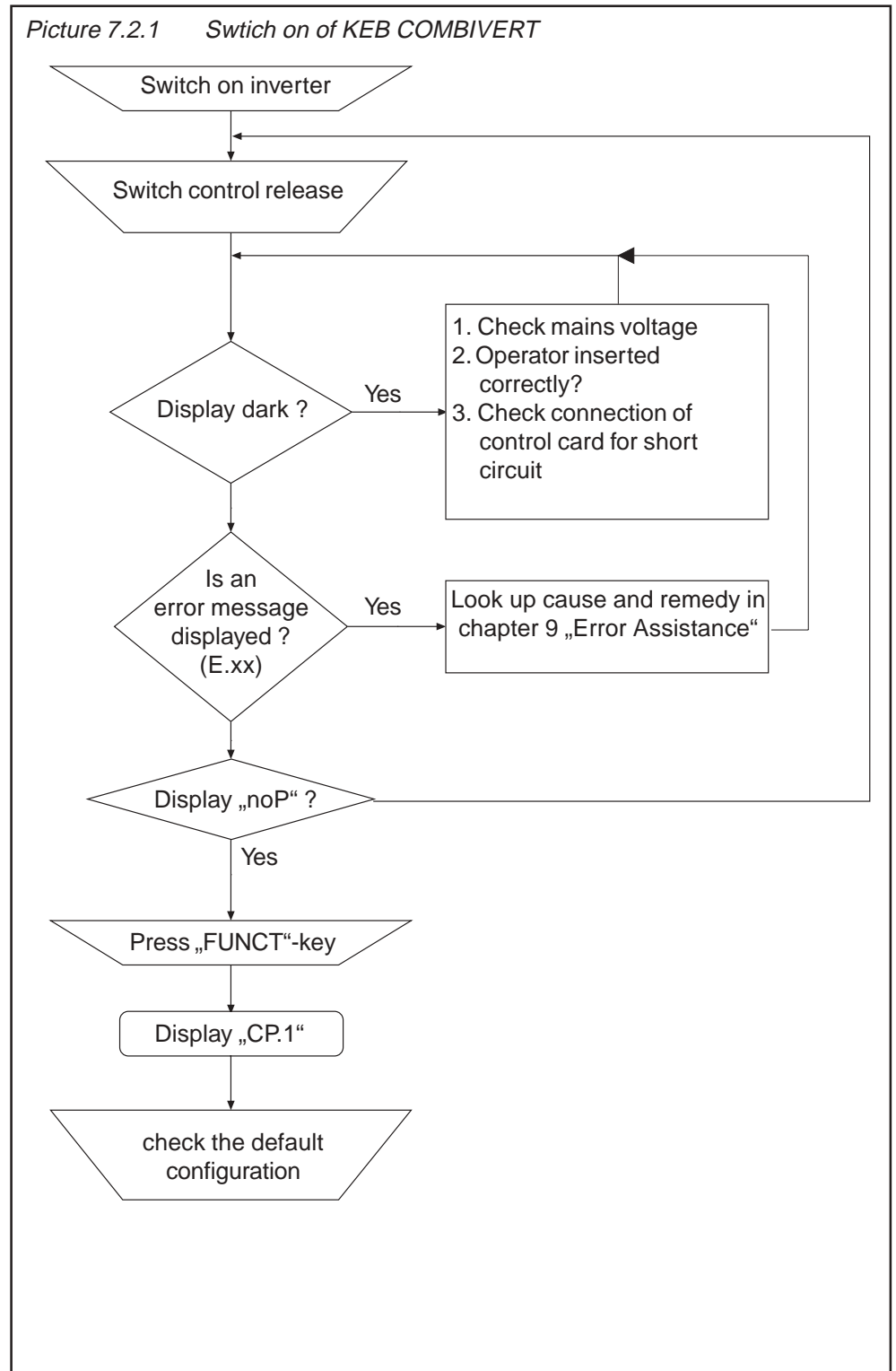
7.2 Initial Start-up

After all preparatory measures have been carried out the KEB COMBIVERT F5 can be switched on.

7.2.1 Switching on of KEB COMBIVERT

The sequence of the switch-on procedure as shown below refers to supplied units with factory setting. Because of the multitude of programs we cannot take into consideration customer-specific adjustments.

Picture 7.2.1 Switch on of KEB COMBIVERT



7.2.2 Basic Settings in the CP-Mode

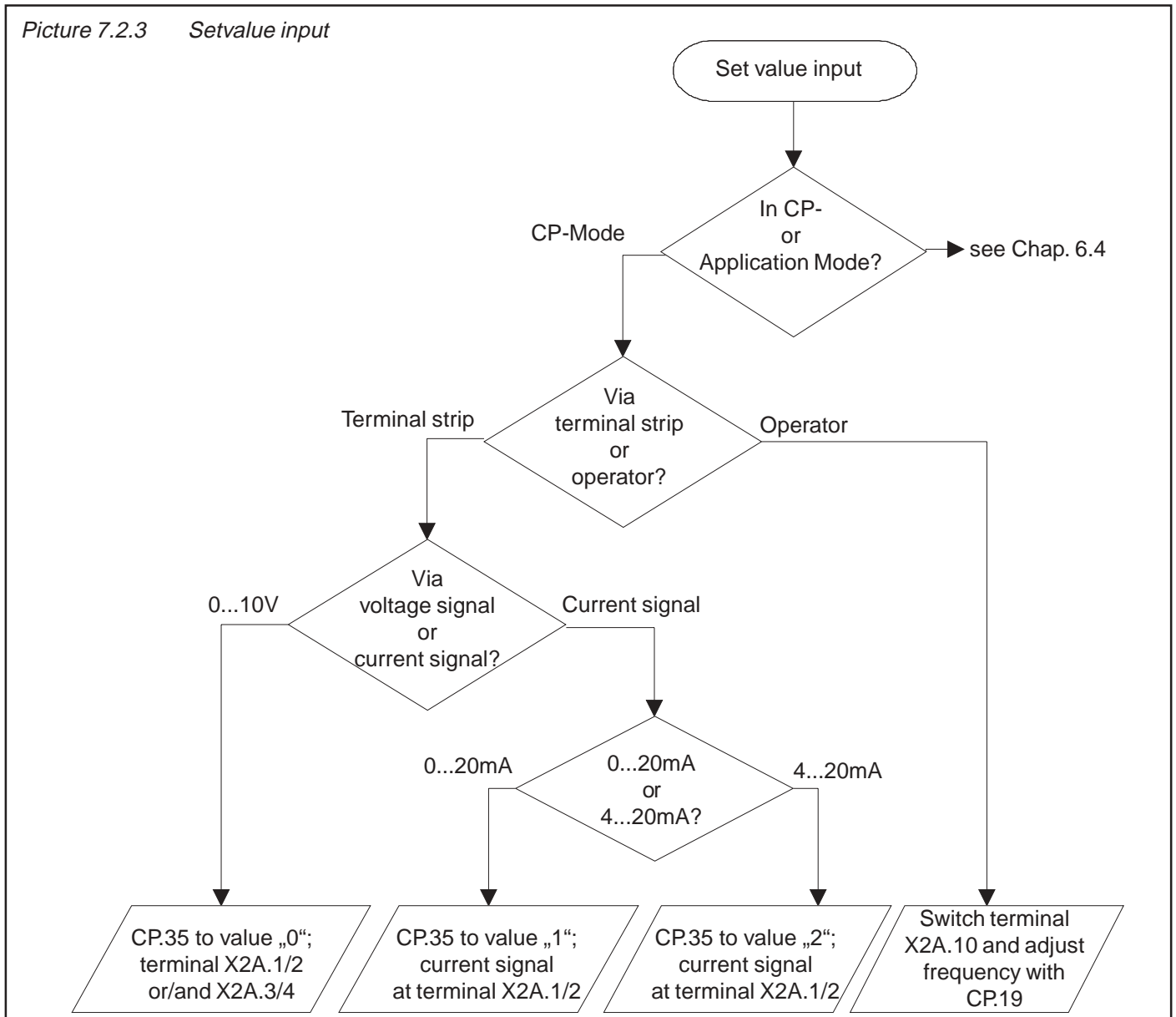
After switch-on with factory setting the inverter is in the CP-Mode. The preadjusted values can be used for 90 % of all applications at the initial start-up. However, the following parameters should be checked and, if necessary, adjusted.

- ☑ Corner frequency CP.16
- ☑ Minimum and maximum frequency CP.10/CP.11
- ☑ Acceleration and deceleration times CP.12/CP.13
- ☑ Boost CP.15
- ☑ Activation of the Motor PTC detection, if a PTC is attached

7.2.3 Set value selection

After the basic settings have been made, it must now be determined how the set value input is done.

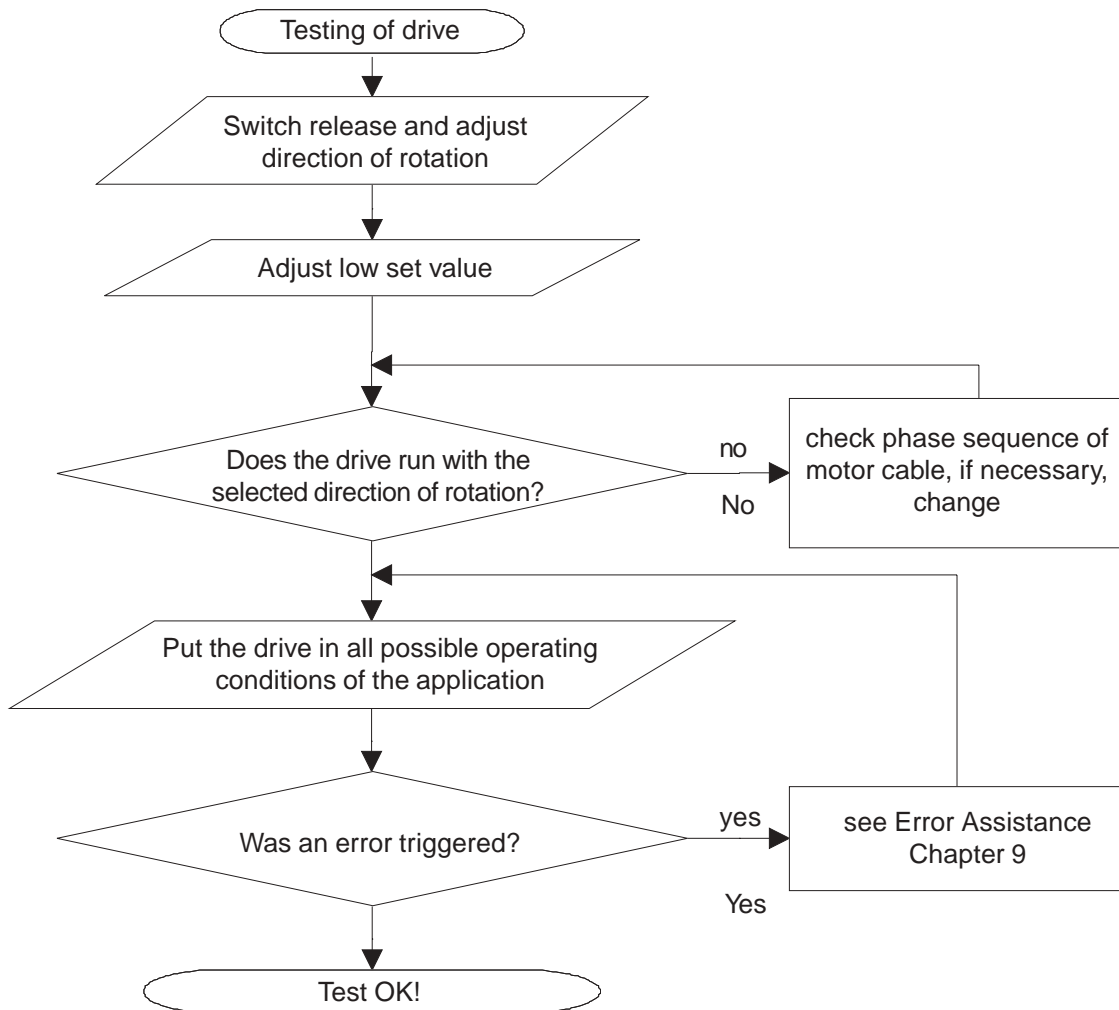
Picture 7.2.3 Setvalue input



7.2.4 Testing of Drive

For the drive to always allow a safe controlling through the inverter, carry out the following test under the most adverse operating conditions.

Picture 7.2.4 Testing of drive



Chapter 7	Section 2	Page 6	Date 01.02.02	Name: Basis KEB COMBIVERT F5-G / B	© KEB Antriebstechnik, 2002 All Rights reserved
---------------------	---------------------	------------------	------------------	--	--

1. Introduction

2. Summary

3. Hardware

4. Operation

5. Parameter

6. Functions

7. Start-up

8. Special Operation

currently no entry

9. Error Assistance

10. Project Planning

11. Networks

12. Annex

8. Special Operations

Chapter 8	Section 1	Page 2	Date 10.04.02	Name: Basis KEB COMBIVERT F5	© KEB Antriebstechnik, 2002 All Rights reserved
---------------------	---------------------	------------------	------------------	--	--

- 1. Introduction
- 2. Summary
- 3. Hardware
- 4. Operation
- 5. Parameter
- 6. Functions
- 7. Start-up
- 8. Special Operation
- 9. Error Assistance**
- 10. Project Planning
- 11. Networks
- 12. Annex

- 9.1 Troubleshooting**

- 9.1.1 General 3
- 9.1.2 Error Messages and their Cause 3

9. Error Assistance

The following chapter shall help you to avoid errors as well as help you to determine and remove the cause of errors on your own.

9.1 Troubleshooting

9.1.1 General

If error messages or malfunctions occur repeatedly during operation, the first thing to do is to pinpoint the exact error. To do that go through the following checklist:

- Is the error reproducible ?

For that reset the error and try to repeat it under the same conditions. If the error can be reproduced, the next step is to find out during which operating phase the error occurs.

- Does the error occur during a certain operating phase (e.g. always during acceleration)?

If so, consult the error messages and remove the causes listed there.

- Does the error occur or disappear after a certain time?

That may be an indication for thermal causes. Check, whether the inverter is used in accordance to the ambient conditions and that no moisture condensation takes place.

9.1.2 Error Messages and their Cause

At KEB COMBIVERT **error messages** are always represented with an „E.“ and the appropriate error in the display. Error messages cause the immediate deactivation of the modulation. Restart possible only after reset.

Malfunction are represented with an „A.“ and the appropriate message. Reactions to malfunctions can vary.

Status messages have no addition. The status message shows the current operating status of the inverter (e.g. forward constant run, standstill etc.).

In the following the display and their cause are described.

Display	COMBIVIS Status Messages	Value	Meaning
bbL	base block	76	Power modules for motor de-excitation locked
bon	close brake	85	Brake control, brake engaged (see chapter 6.9)
boFF	open brake	86	Brake control, brake released (see chapter 6.9)
Cdd	calculate drive	82	Measurement of the motor stator resistance
dcb	DC brake	75	Motor is decelerated by a DC-voltage at the output.
dLS	low speed / DC brake	77	Modulation is switched off after DC-braking (see chapter 6.9 „DC-Braking“).
FAcc	forward acceleration	64	Acceleration with the adjusted ramps in clockwise direction of rotation.
Fcon	forward constant	66	Acceleration / deceleration phase is completed and it is driven with constant speed / frequency in clockwise direction of rotation.
FdEc	forward deceleration	65	It is stopped with the adjusted ramp times in clockwise direction of rotation.
HCL	hardware current limit	80	The message is output if the output current reaches the hardware current limit.

Display	COMBIVIS	Value	Meaning			
LAS	LA stop	72	This message is displayed if during acceleration the load is limited to the adjusted load level.			
LdS	Ld stop	73	This message is displayed if during deceleration the load is limited to the adjusted load level or the DC-link current to the adjusted voltage level.			
LS	low speed	70	No direction of rotation pre-set, modulation is off.			
nO_PU	power unit not ready	13	Power circuit not ready or not identified by the control.			
noP	no operation	0	Control release (terminal ST) is not switched.			
PA	positioning active	122	This message is displayed during a positioning process.			
PLS	low speed / power off	84	No modulation after Power-Off			
PnA	position not reachable	123	The specified position cannot be reached within the pre-set ramps. The abort of the positioning can be programmed.			
POFF	power off function	78	Depending on the programming of the function (see chapter 6.9 „Power-off Function“) the inverter restarts automatically upon system recovery or after a reset.			
POSI	positioning	83	Positioning function active (F5-G).			
rAcc	reverse acceleration	67	Acceleration with the adjusted ramp times in anti-clockwise direction of rotation.			
rcon	reverse constant	69	The acceleration / deceleration phase is completed and it is driven with constant speed / frequency in anti-clockwise direction of rotation.			
rdEc	reverse deceleration	68	It is stopped with the adjusted ramp times in anti-clockwise direction of rotation.			
rFP	ready for positioning	121	The drive signals that it is ready to start the positioning process.			
SLL	stall	71	This message is displayed if during constant operation the load is limited to the adjusted current limit.			
SrA	search for ref. active	81	Search for reference point approach active.			
SSF	speed search	74	Speed search function active, that means that the inverter attempts to synchronize onto a running down motor.			
StOP	quick stop	79	The message is output if as response to a warning signal the quick-stop function becomes active.			
Error Messages						
E. br	ERROR brake	56	Error: This error can occur in the case of switched on brake control (see Chapter 6.9.5), if <ul style="list-style-type: none"> • the load is below the minimum load level (Pn.43) at start up or the absence of an engine phase was detected. • the load is too high and the hardware current limit is reached 			
E.buS	ERROR bus	18	Error: Adjusted monitoring time (Watchdog) of communication between operator and PC / operator and inverter has been exceeded.			
E.Cdd	ERROR calc. drive data	60	Error: During the automatic motor stator resistance measurement.			
E.co1	ERROR counter overrun 1	54	Counter overflow encoder channel 1			
E.co2	ERROR counter overrun 2	55	Counter overflow encoder channel 2			
Error Messages						
Chapter	Section	Page	Date	Name: Basis	©	KEB Antriebstechnik, 2002
9	1	4	10.04.02	KEB COMBIVERT F5		All Rights reserved

Display	COMBIVIS	Value	Meaning						
E.dOH	ERROR drive overheat	9	Error: Overtemperature of motor PTC. Error can only be reset at E.ndOH, if PTC is again low-resistance. Causes: <ul style="list-style-type: none"> • resistance at the terminals T1/T2 >1650 Ohm • motor overloaded • line breakage to the temperature sensor 						
E.dri	ERROR driver relay	51	Error: Driver relay. Relay for driver voltage on power circuit has not picked up even though control release was given.						
E.EEP	ERROR EEPROM defective t	21	After reset the operation is again possible (without storage in the EEPROM)						
E. EF	ERROR external fault	31	Error: External error. Is triggered, if a digital input is being programmed as external error input and trips.						
E.EnC	ERROR encoder	32	Error: Cable breakage resolver or incremental encoder						
E.Hyb	ERROR hybrid	52	Invalid encoder interface identifier						
E.HybC	ERROR hybrid changed	59	Error: Encoder interface identifier has changed, it must be confirmed over ec.0 or ec.10.						
E.iEd	ERROR input error detect	53	Error: Hardware error during the start/stop measurement.						
E.InI	ERROR initialisation MFC	57	MFC not booted.						
E.LSF	ERROR load shunt fault	15	Error: Load-shunt relay has not picked up, occurs for a short time during the switch-on phase, but must automatically be reset immediately. If the error message remains the following causes may be applicable: <ul style="list-style-type: none"> • load-shunt defective • input voltage wrong or too low • high losses in the supply cable • braking resistor wrongly connected or damaged • braking module defective 						
E.ndOH	no ERROR drive overheat	11	Motor temperature switch or PTC at the terminals T1/T2 is again in the normal operating range. The error can be reset now.						
E.nOH	no E. over heat pow.mod.	36	Temperature of the heat sink is again in the permissible operating range. The error can be reset now.						
E.nOHI	no ERROR overheat int.	7	No longer overheating in the interior E.OHI, interior temperature has fallen by at least 3°C						
E.nOL	no ERROR overload	17	No more overload, OL-counter has reached 0%; after the error E. OL a cooling phase must elapse. This message appears upon completion of the cooling phase. The error can be reset. The inverter must remain switched on during the cooling phase.						
E.nOL2	no ERROR overload 2	20	The cooling time has elapsed. The error can be reset.						
E. OC	ERROR overcurrent	4	Error: Overcurrent Occurs, if the specified peak current is exceeded. Causes: <ul style="list-style-type: none"> • acceleration ramps too short • the load is too big at turned off acceleration stop and turned off constant current limit • short-circuit at the output • ground fault • deceleration ramp too short • motor cable too long • EMC • DC brake at high ratings active (see 6.9.3) 						
<table border="1" style="width: 100%; border-collapse: collapse;"> <tr> <td style="width: 33%;">© KEB Antriebstechnik, 2002 All Rights reserved</td> <td style="width: 33%;">Name: Basis KEB COMBIVERT F5</td> <td style="width: 10%;">Date 10.04.02</td> <td style="width: 10%;">Chapter 9</td> <td style="width: 10%;">Section 1</td> <td style="width: 10%;">Page 5</td> </tr> </table>				© KEB Antriebstechnik, 2002 All Rights reserved	Name: Basis KEB COMBIVERT F5	Date 10.04.02	Chapter 9	Section 1	Page 5
© KEB Antriebstechnik, 2002 All Rights reserved	Name: Basis KEB COMBIVERT F5	Date 10.04.02	Chapter 9	Section 1	Page 5				

Error Assistance

Display	COMBIVIS	Value	Meaning			
E. OH	ERROR overheat pow.mod.	8	Error: Overtemperature of power module. Error can only be reset at E.nOH. Causes: <ul style="list-style-type: none"> insufficient air flow at the heat sink (soiled) ambient temperature too high ventilator clogged 			
E.OH2	ERROR motor protection	30	Electronic motor protective relay has tripped.			
E.OHI	ERROR overheat internal	6	Error: Overheating in the interior: error can only be reset at E.nOHI, if the interior temperature has dropped by at least 3°C			
E. OL	ERROR overload (lxt)	16	Error: Overload error can only be reset at E.nOL, if OL-counter reaches 0% again. Occurs, if an excessive load is applied longer than for the permissible time (see technical data). Causes: <ul style="list-style-type: none"> poor control adjustment (overshooting) mechanical fault or overload in the application inverter not correctly dimensioned motor wrongly wired encoder damaged 			
E.OL2	ERROR overload 2	19	Occurs if the standstill constant current is exceeded (see technical data and overload characteristics). The error can only be reset if the cooling time has elapsed and E.nOL2 is displayed.			
E. OP	ERROR Overvoltage	1	Voltage in the DC-link circuit too high. Occurs if the DC-link circuit voltage exceeds the permissible value. Causes: <ul style="list-style-type: none"> poor controller adjustment (overshooting) input voltage too high interference voltages at the input deceleration ramp too short braking resistor defective or too small 			
E.OS	ERROR over speed	58	Real speed is bigger than the max. Output speed.			
E.PFC	ERROR Power factor control	33	Error in the power factor control			
E.PrF	ERROR prot. rot. for.	46	The drive has driven onto the right limit switch. Programmed response "Error, restart after reset" (see chapter 6.7 "Response to errors or warning messages").			
E.Prr	ERROR prot. rot. rev.	47	The drive has driven onto the left limit switch. Programmed response "Error, restart after reset" (see chapter 6.7 "Response to errors or warning messages").			
E. Pu	ERROR power unit	12	Error: General power circuit fault			
E.Puci	ERROR pow. unit code inv.	49	Error: During the initialization the power circuit could not be recognized or was identified as invalid.			
E.Puch	ERROR power unit changed	50	Error: Power circuit identification was changed; with a valid power circuit this error can be reset by writing to SY.3. If the value displayed in SY.2 is written, only the power-circuit dependent parameters are reinitialized. If any other value is written, then the default set is loaded.			
E.PUCO	ERROR power unit commun.	22	Error: Parameter value could not be written to the power circuit. Acknowledgement from PC <=> OK			
E.PUIN	ERROR power unit invalid	14	Error: Software version for power circuit and control card are different. Error cannot be reset (only at F5-G B-housing)			
Chapter	Section	Page	Date	Name: Basis	©	KEB Antriebstechnik, 2002
9	1	6	10.04.02	KEB COMBIVERT F5		All Rights reserved

Display	COMBIVIS	Value	Meaning						
E.SbuS	ERROR bus synchron	23	Synchronization over sercos-bus not possible. Programmed response "Error, restart after reset" (see chapter 6.7 "Response to errors or warning messages").						
E.SET	ERROR set	39	It has been attempted to select a locked parameter set. Programmed response "Error, restart after reset" (see chapter 6.7 "Response to errors or warning messages").						
E.SLF	ERROR! Software limit switch forward	44	The right software limit switch lies outside the defined limits. Programmed response "Error, restart after reset" (see chapter 6.7 "Response to errors or warning messages").						
E.SLr	ERROR software limit switch reverse	45	The left software limit switch lies outside the defined limits. Programmed response "Error, restart after reset" (see chapter 6.7 "Response to errors or warning messages").						
E. UP	ERROR underpotential	2	Error: Undervoltage (DC-link circuit). Occurs, if DC-link voltage falls below the permissible value. Causes: <ul style="list-style-type: none"> • input voltage too low or instable • inverter rating too small • voltage losses through wrong cabling • the supply voltage through generator / transformer breaks down at very short ramps • At F5-G housing B E.UP is also displayed if no communication takes place between power circuit and control card. • Jump factor (Pn.56) too small (see 6.9.20) • if a digital input was programmed as external error input with error message E.UP (Pn.65). 						
E.UPh	ERROR Phase failure	3	One phase of the input voltage is missing (ripple-detection)						
Warning Messages									
A.buS	ABN.STOP bus	93	Warning: Watchdog for communication between operator/control card or operator/PC has responded. The response to this warning can be programmed (see chapter 6.7 "Response to errors and warning messages").						
A.dOH	ABN.STOP drive over heat	96	The motor temperature has exceeded an adjustable warning level. The switch off time is started. The response to this warning can be programmed (see chapter 6.7 "Response to errors or warning messages"). This warning can be generated only with a special power circuit.						
A. EF	ABN.STOP external fault	90	This warning is triggered via an external input. The response to this warning can be programmed (see chapter 6.7 "Response to errors or warning messages").						
A.ndOH	no A. drive overheat	91	The motor temperature is again below the adjusted warning level. The switch off time is stopped.						
A.nOH	no A. overheat pow.mod.	88	The heat sink temperature is again below the adjusted warning level.						
A.nOHI	no A.STOP overheat int.	92	The temperature in the interior of the inverter is again below the warning threshold.						
A.nOL	no ABN.STOP overload	98	Warning: no more overload, OL counter has reached 0 %.						
A.nOL2	no ABN.STOP overload 2	101	The cooling time after "Warning! Overload during standstill" has elapsed. The warning message can be reset.						
<table border="1" style="width: 100%; border-collapse: collapse;"> <tr> <td style="width: 33%;">© KEB Antriebstechnik, 2002 All Rights reserved</td> <td style="width: 33%;">Name: Basis KEB COMBIVERT F5</td> <td style="width: 10%;">Date 10.04.02</td> <td style="width: 10%;">Chapter 9</td> <td style="width: 10%;">Section 1</td> <td style="width: 10%;">Page 7</td> </tr> </table>				© KEB Antriebstechnik, 2002 All Rights reserved	Name: Basis KEB COMBIVERT F5	Date 10.04.02	Chapter 9	Section 1	Page 7
© KEB Antriebstechnik, 2002 All Rights reserved	Name: Basis KEB COMBIVERT F5	Date 10.04.02	Chapter 9	Section 1	Page 7				

Display	COMBIVIS	Value	Meaning			
A. OH	A.STOP overheat pow.mod	89	A level can be defined, when it is exceeded this warning is output. A response to this warning can be programmed (see chapter 6.7 "Response to errors or warning messages").			
A.OH2	ABN.STOP motor protect.	97	Warning: electronic motor protective relay has tripped. The response to this warning can be programmed (see chapter 6.7 "Response to error or warning messages").			
A.OHI	ABN.STOP overheat int.	87	The temperature in the interior of the inverter lies above the permissible level. The switch off time was started. The programmed response to this warning message is executed (see chapter 6.7 "Response to errors or warning messages").			
A. OL	ABN.STOP overload	99	A level between 0 and 100 % of the load counter can be adjusted, when it is exceeded this warning is output. The response to this warning can be programmed (see chapter 6.7 "Response to errors or warning messages").			
A.OL2	ABN.STOP overload 2	100	The warning is output when the standstill continuous current is exceeded (see technical data and overload characteristics). The response to this warning can be programmed (see chapter 6.7 "Response to errors and warning messages"). The warning message can only be reset after the cooling time has elapsed and A.nOL2 is displayed.			
A.PrF	ABN.STOP prot. rot. for.	94	The drive is driven onto the right limit switch. The response to this warning can be programmed (see chapter 6.7 "Response to errors and warning messages").			
A.Prr	ABN.STOP prot. rot. rev.	95	The drive is driven onto the left limit switch. The response to this warning can be programmed (see chapter 6.7 "Response to errors and warning messages").			
A.SbuS	ABN.Bus synchron	103	Synchronization over sercos-bus not possible. The response to this warning can be programmed (see chapter 6.7 "Response to errors and warning messages").			
A.SET	ABN.STOP set	102	Warning: set selection: It has been attempted to select a locked parameter set. The response to this warning can be programmed (see chapter 6.7 "Response to errors or warning messages").			
A.SLF	ABN.Software limit switch forward	104	The right software limit switch lies outside the defined limits. The response to this warning can be programmed (see chapter 6.7 "Response to errors or warning messages").			
A.SLr	ABN.Software limit switch reverse	105	The left software limit switch lies outside the defined limits. The response to this warning can be programmed (see chapter 6.7 "Response to errors or warning messages").			
Chapter	Section	Page	Date	Name: Basis	©	KEB Antriebstechnik, 2002
9	1	8	10.04.02	KEB COMBIVERT F5		All Rights reserved

1. Introduction

2. Summary

3. Hardware

4. Operation

5. Parameter

6. Functions

7. Start-up

8. Special Operation

9. Error Assistance

10. Project Planning

11. Networks

12. Annex

10.1 General Design

10.1.1 Control Cabinet Design
Calculation 3
10.1.2 Design of Braking Resistors 4
11.1.3 Cable and Fuses 6

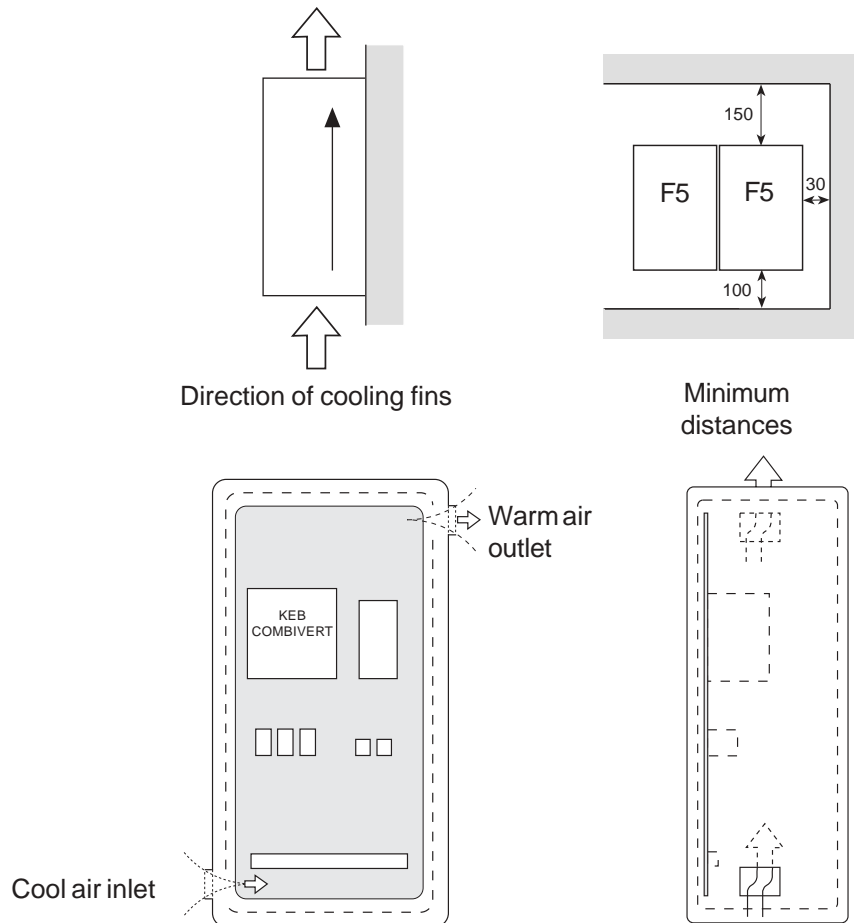
Chapter 1	Section 10	Page 2	Date 10.04.02	Name: Basis KEB COMBIVERT F5	© KEB Antriebstechnik, 2002 All Rights reserved
---------------------	----------------------	------------------	------------------	--	--

10. Project Planning

The following chapter shall assist you in the planning stage of applications.

10.1 General Design

10.1.1 Control Cabinet Design Calculation



Control cabinet surface

Calculation of control cabinet surface:

$$A = \frac{P_v}{\Delta T \cdot K} \text{ [m}^2\text{]}$$

- A = control cabinet surface [m²]
- ΔT = temperature differential [K]
(standard value= 20 K)
- K = coefficient of heat transmission [$\frac{W}{m^2 \cdot K}$]
(standard value = $5 \frac{W}{m^2 \cdot K}$)

- P_v = power loss (see Technical Data)
- V = air flow rate of fan

Air flow rate with fan cooling :

$$V = \frac{3,1 \cdot P_v}{\Delta T} \text{ [m}^3\text{/h]}$$

For more details please refer to the catalogs of the control cabinet manufacturers.

10.1.2 Design of Braking Resistors

The KEB COMBIVERT fitted with an external braking resistor or an external braking option is suitable for a limited 4-quadrant operation. The braking energy, fed into the DC-bus at generatoric operation, is dissipated over the braking transistor to the braking resistor. The braking resistor heats up during the braking process. If it is installed in a control cabinet sufficient cooling of the control cabinet interior and sufficient distance to the KEB COMBIVERT must be observed.

Different braking resistors are available for the KEB COMBIVERT. Please refer to the next page for the corresponding formula and restrictions (valid range)

1. Preset desired braking time.
2. Calculate braking time without braking resistor (t_{Bmin}).
3. If the desired braking time shall be smaller than the calculated time, it is necessary to use a braking resistor. ($t_B < t_{Bmin}$)
4. Calculate braking torque (M_B). Take the load torque into account at the calculation.
5. Calculate peak braking power (P_B). The peak braking power must always be calculated for the worst case (n_{max} to standstill).
6. Selection of braking resistor:
 - a) $P_R \geq P_B$
 - b) P_N is to be selected according to the cycle time (c.d.f.).The braking resistors may be used only for the listed unit sizes. The maximum cyclic duration of a braking resistor shall not be exceeded.

6 % c.d.f. = maximum braking time	8 s
25 % c.d.f. = maximum braking time	30 s
40 % c.d.f. = maximum braking time	48 s

For longer cyclic duration times special designed braking resistors are necessary. The continuous output of the braking transistor must be taken into consideration.

7. Check, whether the desired braking time is attained with the braking resistor (t_{Bmin}).

Restriction: Under consideration of the rating of the braking resistor and the brake power of the motor, the braking torque may not exceed 1.5times of the rating torque of the motor.

When utilizing the maximum possible braking torque the frequency inverter must be dimensioned for the higher current.

Braking time *DEC*

The braking time *DEC* is adjusted at the frequency inverter. If it is chosen too small the KEB COMBIVERT switches off automatically and the error message *OP* or *OC* appears. The approximate braking time can be determined according to following formulae.

Formula

1. Braking time without braking resistor

$$t_{Bmin} = \frac{(J_M + J_L) \cdot (n_1 - n_2)}{9,55 \cdot (K \cdot M_N + M_L)}$$

Valid range: $n_1 > n_N$

(Field weakening range)

2. Braking torque (necessary)

$$M_B = \frac{(J_M + J_L) \cdot (n_1 - n_2)}{9,55 \cdot t_B} - M_L$$

Condition: $M_B \leq 1,5 \cdot M_N$

$f \leq 70 \text{ Hz}$

3. Peak braking power

$$P_B = \frac{M_B \cdot n_1}{9,55}$$

Condition: $P_B \leq P_R$

4. Braking time with braking resistor

$$t_{Bmin}^* = \frac{(J_M + J_L) \cdot (n_1 - n_2)}{9,55 \cdot (K \cdot M_N + M_L + \frac{P_R \cdot 9,55}{(n_1 - n_2)})}$$

Valid range: $n_1 > n_N$

Condition: $\frac{P_R \cdot 9,55}{(n_1 - n_2)} \leq M_N \cdot (1,5 - K)$

$f \leq 70 \text{ Hz}$

$P_B \leq P_R$

K = 0,25 for motors up to	1,5 kW
0,20 for motors	2,2 to 4 kW
0,15 for motors	5,5 to 11 kW
0,08 for motors	15 to 45 kW
0,05 for motors	> 45 kW

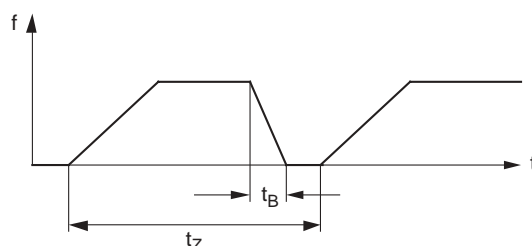
J_M	= mass moment of inertia motor	[kgm ²]
J_L	= mass moment of inertia load	[kgm ²]
n_1	= motor speed prior to deceleration	[rpm]
n_2	= motor speed after deceleration (standstill= 0 rpm)	[rpm]
n_N	= rated motor speed	[rpm]
M_N	= rated motor torque	[Nm]
M_B	= braking torque (necessary)	[Nm]
M_L	= load torque	[Nm]
t_B	= braking time (necessary)	[s]
t_{Bmin}	= minimum braking time	[s]
t_z	= cycle time	[s]
P_B	= peak braking power	[W]
P_R	= peak power of braking resistor	[W]

Cyclic duration factor (cdf)

Cyclic duration factor for cycle time $t_z \leq 120 \text{ s}$ Cyclic duration factor for cycle time $t_z > 120 \text{ s}$

$$cdf = \frac{t_B}{t_z} \cdot 100 \%$$

$$cdf = \frac{t_B}{120 \text{ s}} \cdot 100 \%$$



10.1.3 Cable and Fuses

By means of this section you can check whether you can still optimize your machine with regard to the material usage. The specifications are derived from the DIN VDE 0298 Part 4. The values apply approximately and only for the intended operation. In border cases always proceed in accordance with the above standard. The following table shows the current-carrying capacity of 3- and/or 5-wire PVC cables (i.e. 2 and/or 3 loaded wires) in dependence on the ambient temperature. The current is to be laid out to the input current of the frequency inverter.

Cross section of feed cable		Current in [A] at			
Standard	Alternatively	30°C	40°C	45°C	50°C
0,5 mm ²	-	7	6	6	5
0,75 mm ²	-	12	10	10	9
1 mm ²	-	15	13	13	11
1,5 mm ²	-	18	16	15	13
2,5 mm ²	-	26	23	22	18
4 mm ²	2 x 1,5 mm ²	34	30	29	24
6 mm ²	2 x 2,5 mm ²	44	38	37	31
10 mm ²	2 x 4 mm ²	61	53	51	43
16 mm ²	2 x 6 mm ²	82	71	69	58
25 mm ²	2 x 10 mm ²	108	94	91	77
35 mm ²	2 x 16 mm ²	135	117	113	96
50 mm ²	2 x 16 mm ²	168	146	141	119
70 mm ²	2 x 25 mm ²	207	180	174	147
95 mm ²	2 x 35 mm ²	250	218	210	178
120 mm ²	2 x 50 mm ²	292	254	245	207
150 mm ²	2 x 50 mm ²	330	287	277	234
185 mm ²	2 x 70 mm ²	394	343	331	280
240 mm ²	2 x 95 mm ²	450	392	378	320
300 mm ²	2 x 95 mm ²	507	441	426	360
400 mm ²	2 x 150 mm ²	661	575	555	469
500 mm ²	2 x 185 mm ²	774	673	650	550

The use of special cables or the way of laying the cables allows even higher currents (see DIN VDE 0298 Part 4). The motor cable must correspond to the cross-section of the mains cable.

If in the case of long lines (>30m) still maximum torque is required at the motor shaft, the cable should be dimensioned for the next larger cross-section in order to reduce line resistances.

Mains fuses are to be designed for the rated input current of the inverter. The current/time-characteristic of the fuse must be slow-acting in order to avoid premature tripping when utilizing the power reserves of the inverter.

1. Introduction

2. Summary

3. Hardware

4. Operation

5. Parameter

6. Functions

7. Start-up

8. Special Operation

9. Error Assistance

10. Project Planning

11. Networks

12. Annex

11.1 Network Components

11.2 DRIVECOM-Parameters

11.1.1	Available Hardware	3
11.1.2	RS232-Cable PC/Inverter	3
11.1.3	HSP5-Cable	3
11.1.4	Interface Operator	4
11.1.5	Profibus Operator	5
11.1.6	InterBus Operator	6
11.1.7	CanOpen Operator	7
11.1.8	Sercos Operator	8

Chapter 11	Section 1	Page 2	Date 10.04.02	Name: Basis KEB COMBIVERT F5	© KEB Antriebstechnik, 2002 All rights reserved
----------------------	---------------------	------------------	------------------	--	--

11. Networks

The KEB COMBIVERT F5 can be easily integrated into different networks. For that purpose the inverter is fitted with an operator that is appropriate for the respective bus system. Following hardware components are available:

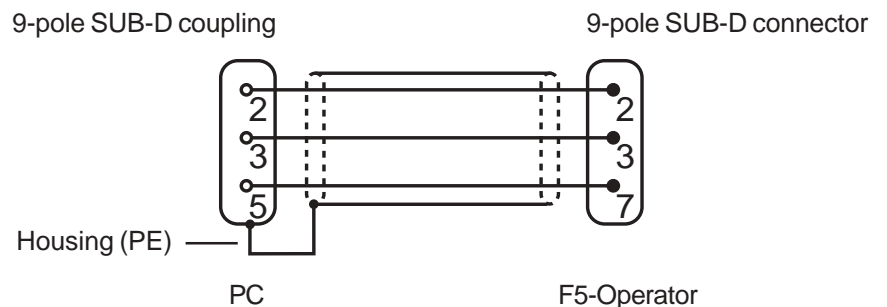
11.1 Network Components

11.1.1 Available Hardware

- **RS232-Cable PC/Operator** Part No.: **00.58.025-001D**
for operation with interface operator
- **HSP5-Adaptor PC/Control board** Part No.: **00.F5.0C0-0001**
for operation without operator; RS232 => TTL
- **F5 Interface-Operator** Part No.: **00.F5.060-2000**
serial networks in RS232 or RS485-standard
- **F5 Profibus-DP-Operator** Part No.: **00.F5.060-3000**
- **F5 InterBus-Operator** Part No.: **00.F5.060-4000**
- **InterBus-Remote bus interface connection (in connection with Interface-Operator)** Part-No.: **00.B0.0BK-K001**
- **F5 CanOpen-Operator** Part No.: **00.F5.060-5000**
- **F5 Sercos-Operator** Part No.: **00.F5.060-6000**

11.1.2 RS232-Cable PC / Operator 00.58.025-001D

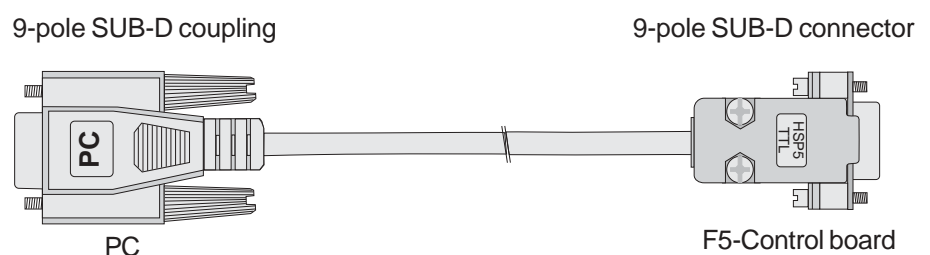
The cable of 3m length is used for the direct RS232-connection between PC (9-pole SUB-D-connector) and operator.



! The RS232-cable is suitable exclusively for the communication between PC and Operator. If the cable is plugged in directly onto the control board, it can lead to the destruction of the interface of the PC.

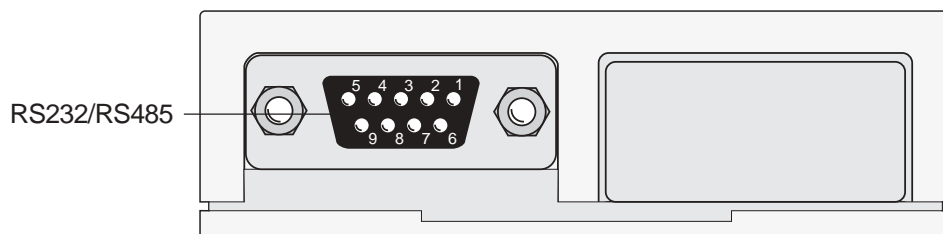
11.1.3 HSP5-Cable PC / Control Board 00.F5.0C0-0001

The HSP5-cable is used for the direct connection between PC and control board. The necessary conversion to TTL-level occurs in the cable.



11.1.4 Interface-Operator 00.F5.060-2000

A potential-separated RS232/RS484 interface is integrated in the interface operator (00.F5.060-2000). The telegram structure is compatible to protocol DIN 66019 and ANSI X3.28 as well as to protocol expansion DIN 66019 II.



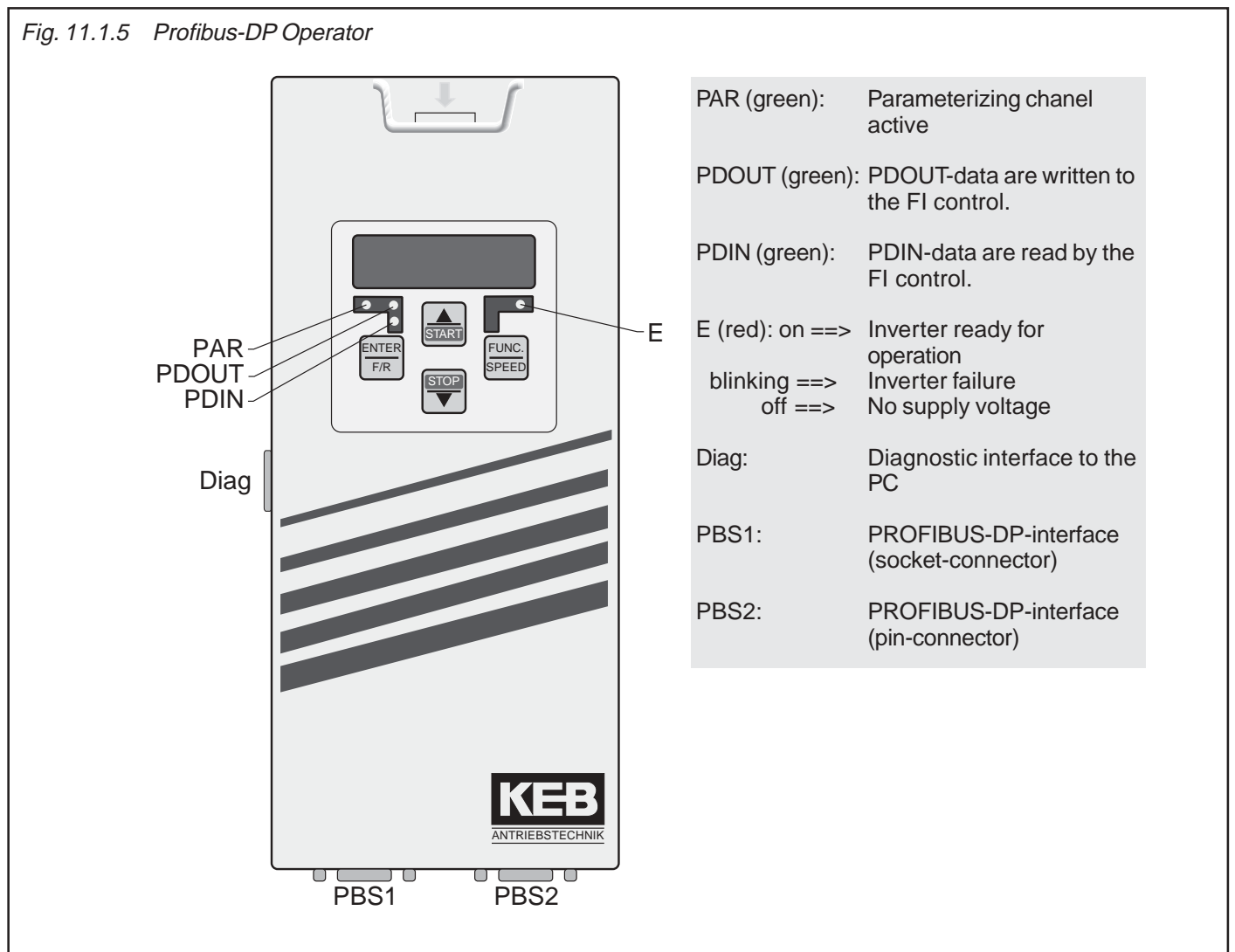
PIN	Signal	Meaning
1	–	Reserved
2	TxD	Transmission signal/RS232
3	RxD	Receive signal/RS232
4	RxD-A (+)	Receive signal A/RS485
5	RxD-B (-)	Receive signal B/RS485
6	VP	Supply voltage -Plus +5V ($I_{max}=10mA$)
7	GND	Data reference potential; earth for VP
8	TxD-A (+)	Transmission signal A/RS485
9	TxD-B (-)	Transmission signal B/RS485

**11.1.5 Profibus-DP-Operator
00.F5.060-3000**

The PROFIBUS-DP-interface module realizes a passive user (Slave). This means that the PROFIBUS-DP-interface module only transmits, if it receives an enquiry for that from the master.

The PROFIBUS-DP-protocol defines different operating conditions, that must be executed first, before the actual user data can be exchanged. The responsible DP-master must first parameterize and then configure his slaves. If these two functions are successfully completed, the cyclic exchange of user data begins.

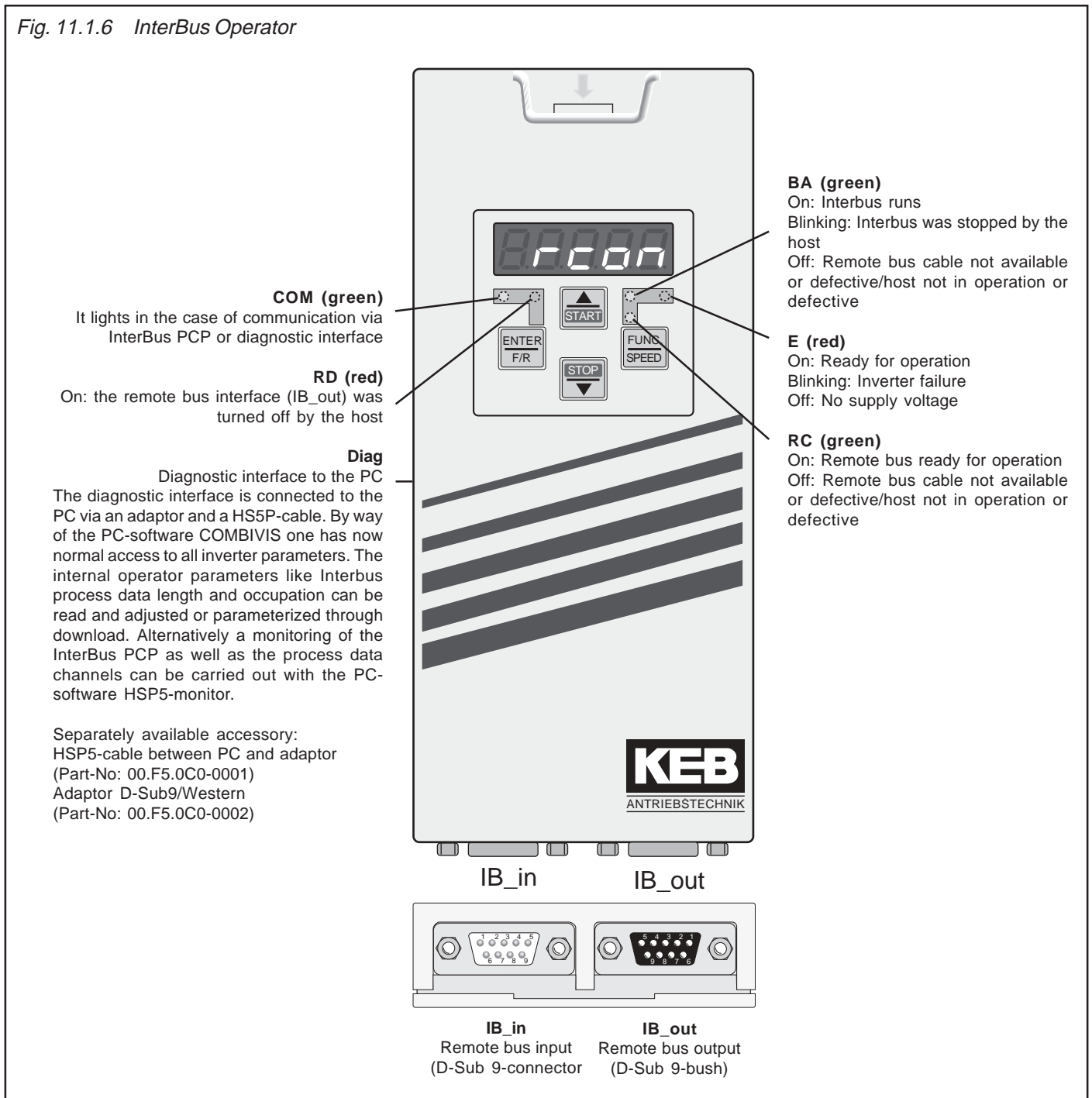
Fig. 11.1.5 Profibus-DP Operator



11.1.6 InterBus Operator
00.F5.060-4000

The InterBus operator F5 is a slip-on operator with interbus 2-wire remote bus connection for KEB COMBIVERT F5. The voltage supply occurs via the inverter, for an independent supply it can also be fed in externally over the control terminal strip of the inverter. Over the PCP channel 0, 1, 2 or 3 interbus register words can be configured for the process data channel. Parallel to the field bus operation the operation via the integrated display/keyboard as well as a further serial interface for diagnosis/parameterization (COMBIVIS) is possible.

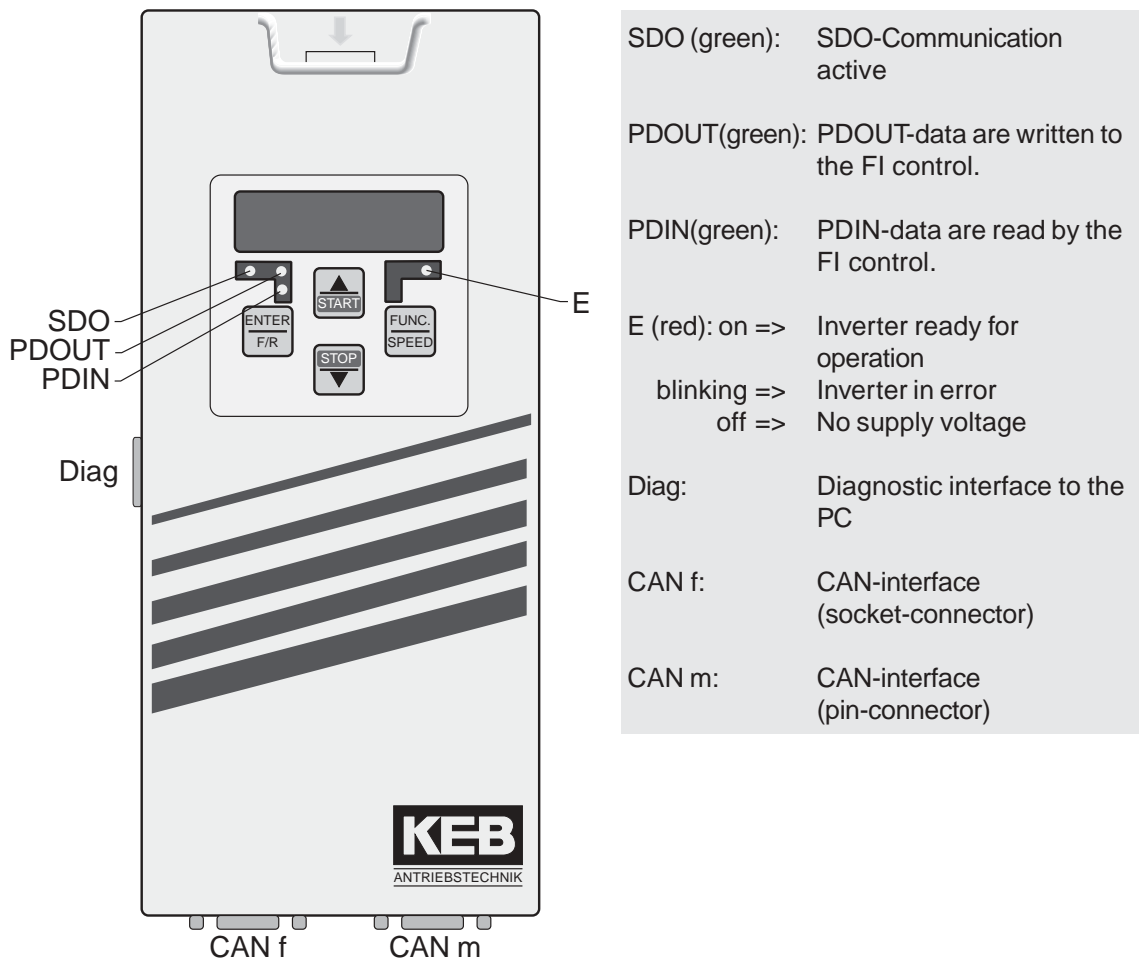
Fig. 11.1.6 InterBus Operator



11.1.7 CanOpen Operator
00.F5.060-5000

CAN is a **Multi-Master-System**. This means every nodes has access to the BUS and can send telegrams. In order to prevent problems when two nodes simultaneously access the BUS, the CAN-BUS has an arbitration phase which determines who may continue to send his telegram. When there is a conflict in accessing BUS the user with the lowest telegram number (identifier) has priority. This user then can completely send his telegram without repeating the first part. All other nodes go into receiving status and stop sending their telegram. The available telegram numbers in the CAN version 2.0A are limited to 2032 identifiers (0...2031).

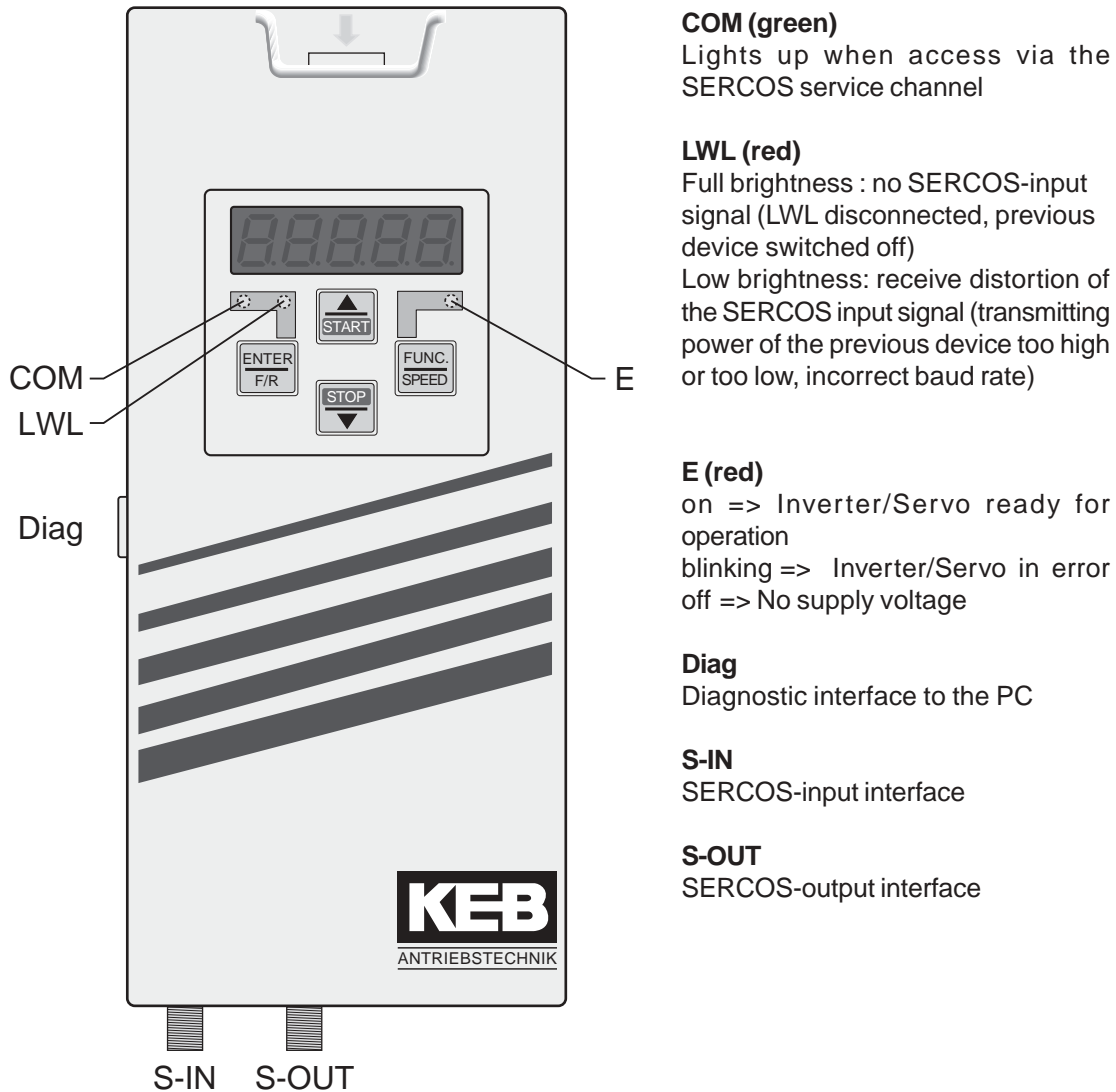
Fig. 11.1.7 CanOpen Operator



**11.1.8 Sercos Operator
00.F5.060-6000**

The herein described unit is a pluggable operator with SERCOS-interface for the frequency inverter or servo KEB COMBIVERT F5. As far as possible the hard and software were developed taking the DIN/EN 61491 into consideration. The voltage supply is made by the inverter and as an independent external supply it can be made via the terminal strip of the inverter. The SERCOS-interface is designed as optical fibre ring for plastic (POF) or fibre glas cable (HCS) with F-SMA plugs. The SERCOS-service channel as well as cyclic data transfer are available. Parallel to SERCOS-operation the operation via integrated display/keyboard and also an additional serial interface for diagnosis / parameterization (KEB COMBIVIS) is possible (depending on the operation mode it may be disabled). SERCOS-operation parameters like slave address, transmitting power etc. can be adjusted via the keyboard.

Picture11.1.8 Sercos-Operator



- 1. Introduction
- 2. Summary
- 3. Hardware
- 4. Operation
- 5. Parameter
- 6. Functions
- 7. Start-up
- 8. Special Operation
- 9. Error Assistance
- 10. Project Planning
- 11. Networks**
- 12. Annex

- 11.1 Network Components**
- 11.2 Bus Parameters**

- 11.2.1 Adjustment of Inverter Address 3
- 11.2.2 Baud Rate ext. Bus 3
- 11.2.3 Baud Rate int. Bus 3
- 11.2.4 Watchdog-Time 3
- 11.2.5 Response to E.bus 3
- 11.2.6 HSP5 Watchdog-Time 3
- 11.2.7 Status and Control Word 4
- 11.2.8 Speed Setting via Bus 5
- 11.2.9 Used Parameters 6

Chapter 11	Section 2	Page 2	Date 10.04.02	Name:Basis KEB COMBIVERT F5	© KEB Antriebstechnik, 2002 All rights reserved
----------------------	---------------------	------------------	------------------	---------------------------------------	--

11.2. Bus Parameters

11.2.1 Adjustment of Inverter Address (Sy.6)

The address under which the inverter is addressed by „COMBIVIS“ or another control is adjusted via Sy.6. Values between 0 and 239 are possible, the default value is 1. If several inverters are operated on the bus simultaneously, it is absolutely necessary to assign different addresses to them, since otherwise it leads to communication failures because several inverters may answer at the same time. The description of the DIN 66019II protocol (C0.F5.01I-K001) contains further information to this. While loading the default parameters there is no reset of Sy.6.

11.2.2 Baud Rate ext. Bus (Sy.7)

Following values for the baud rate of the serial interface are possible:

Parameter value	Baud rate
0	1200 Baud
1	2400 Baud
2	4800 Baud
3 (default)	9600 Baud
4	19200 Baud
5	38400 Baud
6	55500 Baud

If the value for the baud rate is changed via the serial interface, it can be changed again only by the keyboard or after adapting the baud rate of the master, as no communication is possible with different baud rates of master and slave.

Should problems occur at the data transmission choose a transfer rate of maximal 38400 baud.

11.2.3 Baud Rate int. Bus (Sy.11)

With the internal baud rate the transmission rate is defined between operator and inverter. Following values are possible (dependent of the inverter):

Value	Baudrate	Value	Baudrate	Value	Baudrate
3	9,6 kBaud	6	55,5 kBaud	9	115,2 kBaud
4	19,2 kBaud	7	57,6 kBaud	10	125 kBaud
5	38,4 kBaud	8	100 kBaud	11	250 kBaud

11.2.4 Watchdog-Time (Pn.6)

For a continual check it is possible to trigger an error message of the inverter at the completion of an adjustable time (0.01...10 s) during which no telegram is received. The function can be deactivated by adjusting the value „off“.

11.2.5 Response to E.bus (Pn.5)

This parameter determines the response to a Watchdog-error. Depending on the selected setting a message E.buS or A.buS is output (further information in Chapter 6.7.6).

11.2.6 HSP5 Watchdog Time (sY.9)

The HSP5 Watchdog-function monitors the communication of the HSP5-interface (control card - operator; or control card - PC). After expiration of an adjustable time (0,01...10 s) without incoming telegrams, the response adjusted in Pn.5 is triggered. The value „off“ deactivates the function.

11.2.7 Control and Status Word

The control word is used for the status control of the inverter via bus. With the status word the current state of the inverter is read out.

Control word low Sy.50

Some parameters must be adjusted as follows, so that the inverter can respond to the control word.

Bit	Function	Description
0	Control release	0 = control release not given; 1= control release given; if the control release is given via software, terminal ST must be set. Moreover, all control releases are AND-operated via software (di.1 Bit 0 and di.2 Bit 0 must be set).
1	Reset	Reset out of the change from 0 => 1
2	Run / Stop	0 = set rotation Stop; 1 = set rotation Run (source of rotation op.1 = 8 or 9)
3	For / Rev	0 = set rotation forward; 1 = set rotation reverse (source of set rotation op.1 = 8 or 9)
4-6	Current Set	0...7 = parameter set 0...7 (source of set selection fr.2 = 5)
7	Free	
8	Fast stop	0 = fast stop inactive; 1 = fast stop active
9-15	Free	

Control word high Sy.41

The control word high is bit-coded and structured as follows.

Bit	Function	Description
16	I1	Or-operation with di.2 Bit 4
17	I2	Or-operation with di.2 Bit 5
18	I3	Or-operation with di.2 Bit 6
19	I4	Or-operation with di.2 Bit 7
20	IA	Or-operation with di.2 Bit 8
21	IB	Or-operation with di.2 Bit 9
22	IC	Or-operation with di.2 Bit 10
23	ID	Or-operation with di.2 Bit 11
24	O1	Or-operation with ru.25 Bit 0
25	O2	Or-operation with ru.25 Bit 1
26	R1	Or-operation with ru.25 Bit 2
27	R2	Or-operation with ru.25 Bit 3
28		
...	free	
31		

Control word long Sy.43

The control word long (32 Bit) consists of Sy.51 and Sy.42.

Status word low Sy.51

The current state of the inverter can be read out with the status word.

Bit	Function	Description
0	Control release	0=control release not given; 1=control release given (AND-operated with di.1 Bit 0)
1	Error	0=no error; 1=an error occurred
2	Run / Stop	0=actual rotation Stop; 1=actual rotation Run
3	For / Rev	0=actual rotation forward; 1=actual rotation reverse
4-6	Current set	Indication of current parameter set
7	Free	
8	Fast stop	0 = fast stop inactive; 1 = fast stop active
9-15	Free	

Status word high Sy.42 The status word high is bit-coded and structured as follows.

Bit	Function	Beschreibung
16	I1	Status ru.22 Bit 4
17	I2	Status ru.22 Bit 5
18	I3	Status ru.22 Bit 6
19	I4	Status ru.22 Bit 7
20	IA	Status ru.22 Bit 8
21	IB	Status ru.22 Bit 9
22	IC	Status ru.22 Bit 10
23	ID	Status ru.22 Bit 11
24	O1	Status ru.25 Bit 0
25	O2	Status ru.25 Bit 1
26	R1	Status ru.25 Bit 2
27	R2	Status ru.25 Bit 3
28	OA	Status ru.25 Bit 4
29	OB	Status ru.25 Bit 5
30	OC	Status ru.25 Bit 6
31	OD	Status ru.25 Bit 7





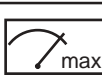

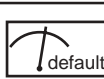
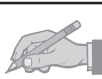
Status word long Sy.44 The status word long (32 Bit) consists of Sy.51 and Sy.42.

11.2.8 Speed Setting via Bus

Setpoint speed Sy.52 Preadjustment of the setpoint speed in the range of ± 16000 rpm. The source of direction of rotation is determined via oP.1, just as with the other absolute setpoint sources. The setpoint source oP.0 must be adjusted to „5“ via Sy.52 for setpoint setting.

Actual speed Sy.53 Via this parameter the current actual speed can be read out in rpm. The direction of rotation is signalled by the sign.

11.2.9 Used Parameters

Param.	Adr.								
Pn.5	0405h	✓	-	-	0	6	1	6	-
Pn.6	0406h	✓	-	-	0.00 s	10.00 s	0.01 s	0.00 s	0.00 = off
Sy.6	0006h	✓	-	✓	0	239	1	1	-
Sy.7	0007h	✓	-	✓	0	6	1	3	-
Sy.9	0009h	✓	-	-	0.00 s	10.00 s	0.01 s	0.00 s	0.00 = off
Sy.11	000Bh	✓	-	✓	3	11	1	5	-
Sy.41	0029h	✓	-	✓	0	65536	1	0	-
Sy.42	002Ah	-	-	-	0	65536	1	0	-
Sy.43	0032h	✓	-	✓	-2^{31}	2^{31-1}	1	0	-
Sy.44	0033h	-	-	-	-2^{31}	2^{31-1}	1	0	-
Sy.50	0032h	✓	-	✓	0	65536	1	0	-
Sy.51	0033h	-	-	-	0	65536	1	0	-
Sy.52	0034h	✓	-	-	-16000 rpm	16000 rpm	1 rpm	0 rpm	-
Sy.53	0035h	✓	-	-	-16000 rpm	16000 rpm	1 rpm	0 rpm	-

1. Introduction

2. Summary

3. Hardware

4. Operation

5. Parameter

6. Functions

7. Start-up

8. Special Operation

9. Error Assistance

10. Project Planning

11. Networks

12. Annex

13.1 Search and Find

13.1.1	Index	3
13.1.2	KEB - Worldwide	11
13.1.3	Domestic Representations	13

Chapter 12	Section 1	Page 2	Date 07.02.02	Name: Basis KEB COMBIVERT F5-G / B	© KEB Antriebstechnik, 2002 All Rights reserved
----------------------	---------------------	------------------	------------------	--	--

12. Annex

12.1 Search and Find

12.1.1 Index

A			
Actual frequency display	4.3.5	cn.10...14	6.12.4
An. 0	6.2.4	cn.11...13	6.3.8
An. 1	6.2.5	Control	
An. 2	6.2.5	cabinet	10.1.3
An. 3	6.2.5, 6.3.8	units	3.1.3
An. 4	6.2.6	CP-parameter	4.3.3, 6.13.3
An. 5...7	6.2.7	assignment	6.13.4
An. 8	6.2.8	CP. 0	6.13.3
An. 9	6.2.8	cS. 0	6.11.5
An.10	6.2.4	cS. 1	6.11.5
An.11	6.2.5	cS. 4	6.11.5
An.12	6.2.5	cS. 6	6.11.5
An.13	6.2.5, 6.3.8	cS. 9	6.11.5
An.14	6.2.6	Current limit	4.3.13
An.15...17	6.2.7	Customer Mode	4.1.3
An.18	6.2.8		
An.20	6.2.4	D	
An.21	6.2.5	Delta Boost	6.5.4
An.22	6.2.5	di. 0	6.3.3
An.23	6.2.5, 6.3.8	di. 1	6.3.4
An.24	6.2.6	di. 2	6.3.4
An.25	6.2.7	di. 3...5	6.3.5
An.26	6.2.7	di. 6...8	6.3.6
An.27	6.2.7	di. 9	6.3.8
An.28	6.2.8	di.10	6.3.8
An.29	6.2.8	di.11...22	6.3.9
An.30	6.2.9	dmin/dmax	6.9.30
An.31...45	6.2.11	do. 0...7	6.3.13
An.32	6.2.10	do. 8...24	6.3.16
An.46	6.2.13	do.25...41	6.3.17
Analog		do.42	6.3.18
inputs	6.2.5	dr. 0... 5	6.6.3
save mode	6.2.5	dr. 6	6.6.4
Application Mode	4.1.3	dr. 9	6.6.4
		dr.11	6.7.15
		dr.12	6.7.15
B		Drive-Mode	4.1.3, 4.2.4, 4.4.3
Barring	4.3.5	E	
Base-Block		Ec. 0	6.10.10
Time	6.7.9	Ec. 1	6.10.10
Basic setting	7.2.4	Ec. 2	6.10.12
Baud Rate	11.2.3	Ec. 3	6.10.10
Boost	4.3.9, 6.5.4	Ec. 4	6.10.11
Braking		Ec. 5	6.10.11
resistors	10.1.4	Ec. 6	6.10.11
		Ec. 7	6.10.11
C		Ec.10	6.10.10
CAN-Bus	11.1.3	Ec.11	6.10.10
cn. 0	6.12.5	Ec.12	6.10.12
cn. 1	6.12.5	Ec.13	6.10.10
cn. 2	6.12.6	Ec.14	6.10.11
cn. 3	6.12.6	Ec.15	6.10.11
cn. 4...9	6.12.3	Ec.16	6.10.11

Ec.17	6.10.11	Interference voltage supply	3.1.5	oP.48	6.9.28
Ec.20...23	6.10.14	Introduction	1.1.7	oP.49	6.9.30
Ec.25	6.10.14	Inverter status display	4.3.5	oP.50	6.9.8
Ec.27	6.10.12			oP.52	6.9.9
ED	10.1.4	L		oP.53	6.9.8
EMC		LA-/LD-Stop	6.7.3	oP.54	6.9.8
conform installation	7.1.3	LAD-stop	4.3.13	oP.56...59	6.9.8
Encoder		LE. 0...7	6.3.22	oP.60	6.4.7
power supply	6.10.7	LE. 8...15	6.3.15	oP.61	6.4.7
track change	6.10.11	LE.16	6.3.15	oP.62	6.4.13
ENTER-parameter	4.1.4	LE.17	6.3.8, 6.9.12		
Error		LE.18	6.9.12	P	
assistance	9.1.3	LE.19	6.3.8, 6.9.12	Parameter	4.1.3, 5.1.3
messages	9.1.3	LE.20	6.9.13	designation	4.1.3
F		LE.21	6.9.11	groups	4.1.3
Factory setting	4.3.4	LE.22	6.3.8, 6.9.12	non-programmable	4.1.5
Fr. 1	6.8.4	LE.23	6.9.12	set	4.1.3
Fr. 2...4	6.8.5	LE.24	6.3.8, 6.9.12	value	4.1.3
Fr. 3	6.8.8	LE.25	6.9.13	Password	4.2.4
Fr. 5	6.8.8	LE.26	6.9.11	levels	4.2.3
Fr. 6	6.8.8	LED	4.4.3	structure	4.2.3
Fr. 7	6.3.8, 6.8.6	M		PID	
Fr. 8	6.7.15	Max. operating frequency	6.10.8	Reset	6.12.4
Fr. 9	6.8.4	MK/MN	6.6.4	Pn. 0...2	6.7.7
Fr.11	6.3.8, 6.8.7	Modulation	4.3.5	Pn. 3	6.7.10
Function principle	2.1.3	Modus	6.9.27	Pn. 4	6.3.8, 6.7.9
Fundamentals	4.1.3	Motorpoti	6.4.4	Pn. 5	6.7.10, 11.2.3
G		N		Pn. 6	6.7.10, 11.2.3
GTR7	6.7.19	Netz-Aus		Pn. 7	6.7.11
Eingangswahl	6.7.19	Regler	6.9.21	Pn. 8	6.7.11
H		NPN	6.3.4	Pn. 9	6.7.10
Hardware	3.1.3	O		Pn.10...15	6.7.11
I		oP. 0	6.4.4, 6.9.9	Pn.12	6.7.18
In-Parameter	6.1.4	oP. 1	6.4.6, 6.9.9	Pn.13	6.7.18
In. 0	6.1.17	oP. 2	6.4.6	Pn.14	6.7.16
In. 1	6.1.17	oP. 3	6.4.4	Pn.16...18	6.7.12
In. 7...17	6.1.18	oP. 5	6.4.4	Pn.19...21	6.7.5
In.22...30	6.1.20	oP. 6	6.4.11	Pn.22...25	6.7.3
In.5	6.10.6	oP. 7	6.4.11	Pn.23	6.3.8
Incremental encoder		oP.10	6.4.11	Pn.26	6.7.7
input	6.10.6	oP.11	6.4.11	Pn.27	6.7.7
output	6.10.7	oP.14	6.4.11	Pn.28	6.9.4
Initial Start-up	7.2.3	oP.15	6.4.11	Pn.28...32	6.9.3
Installation and connection	7.1.3	oP.18...23	6.4.9	Pn.29	6.9.4
InterBus		oP.27	6.4.16	Pn.34...37	6.9.15
Loop	11.1.6	oP.28...35	6.4.14	Pn.39...41	6.9.15
operator	11.1.3	oP.36...41	6.4.15	Pn.43	6.9.15
Interface		oP.44	6.9.27	Pn.44	6.9.19
definition	6.10.6	oP.45	6.9.27	Pn.45	6.9.19, 6.9.20, 6.9.21
operator	11.1.3	oP.46	6.9.27, 6.9.30	Pn.46	6.9.20, 6.9.21
		oP.47	6.9.28	Pn.47...56	6.9.21
				Pn.58...60	6.7.13
				Pn.61	6.7.13
				Pn.62	6.7.11

Pn.63	6.9.31	selection	7.2.4	uF.19	6.5.5
Pn.64	6.7.19	Specifications	2.1.6	Uzk	
Pn.65	6.7.19	Speed		PT1-Zeitkonstante	6.5.5
PNP / NPN	6.3.3	key	4.4.3		
Profibus-DP	11.1.3	search	4.3.14	W	
Project Planning	10.1.3	Sprungfaktor	6.9.20	Watchdog	11.2.3
PT1-Zeitkonstante	6.5.5	Stall		Wieder	
		Acc/Dec time	6.7.6	-anlauf	
R		level	6.7.6	-verzögerung	6.9.23
Rated DC voltage	6.1.16	Start			
Record of changes	1.1.15	key	4.4.3		
Reset	3.1.4	up	7.1.3		
Resetting of		Stop-key	4.4.3		
error messages	4.1.5	Switch			
peak values	4.1.5	on	7.2.3		
Rotation		Sy-Parameter	6.1.21		
setting	4.4.4	Sy. 2	6.1.21		
RS232/485	11.1.3	Sy. 3	6.1.21		
ru-Parameter	6.1.6	Sy. 6	6.1.21, 11.2.3		
ru. 0...3	6.1.6	Sy. 7	6.1.21, 11.2.3		
ru. 4...7	6.1.7	Sy.11	6.1.22, 11.2.3		
ru. 9	6.1.7	Sy.32	6.1.22		
ru.10	6.1.7	Sy.50	6.4.8, 11.2.4		
ru.13	6.12.6	Sy.50...52	6.1.23		
ru.13...16	6.1.8	Sy.50...53	11.2.4, 11.2.5		
ru.14	6.3.5	Sy.51	11.2.4		
ru.15	6.3.18, 6.7.15	Sy.52	11.2.5		
ru.17	6.12.6	Sy.53	6.1.24, 11.2.5		
ru.17...20	6.1.9	Sy.56	6.1.22, 6.1.24		
ru.18	6.12.6	Synchronmotore	6.7.19		
ru.21	6.1.10, 6.3.5				
ru.22	6.1.10	T			
ru.23	6.1.11	Testing of Drive	7.2.5		
ru.24	6.1.11	Timer	6.9.11		
ru.25...28	6.1.12	Torque limit	6.7.13		
ru.28	6.12.6	Trouble shooting	9.1.3		
ru.29...32	6.1.13	Type code	2.1.5		
ru.30	6.12.6				
ru.33...36	6.2.12	U			
ru.33...37	6.1.14	ud. 1	4.2.3, 4.4.3		
ru.38...43	6.1.15	ud. 2	6.5.3		
ru.43	6.9.12	ud. 9	4.4.3		
ru.44	6.9.12	ud.15	6.13.3		
ru.44...46	6.1.16	ud.16	6.13.4		
ru.52	6.1.16	ud.17	6.13.4		
ru.53	6.1.16, 6.12.6	ud.18...21	6.13.6		
ru.59	6.1.16	uF. 0...5	6.5.4		
ru.68	6.1.16	uF. 6...8	6.9.5		
		uF. 9	6.5.5		
		uF.11	6.5.6		
S		uF.12...14	6.7.9		
Selection		uF.16	6.11.4		
of a parameter	4.1.4	uF.17	6.11.4		
Service	4.2.3	uF.18	6.7.9		
Set-point					

Chapter 12	Section 1	Page 6	Date 07.02.02	Name: Basis KEB COMBIVERT F5-G / B	© KEB Antriebstechnik, 2002 All Rights reserved
----------------------	---------------------	------------------	------------------	--	--

12.1.2 KEB-Worldwide

- A** KEB-Antriebstechnik Austria GmbH
H Ritzstraße 8
SK A - 4614 Marchtrenk
 Fon: 0043/7243/53586-0
 Fax: 0043/7243/53586-21
 Mail: info@keb.at
- AUS** Australien Industrial Machinery Services A.I.M.S PTY Ltd.
 Unit 3/45 Horne St.
 AUS - Campbellfield 3061 Victoria
 Fon: 0061/3/9359/0228
 Fax: 0061/3/9359/0286
 Mail: terryo@aimservices.com.au
 I-Net: www.aimservices.com.au
- B** KEB Antriebstechnik
 Vertriebsbüro Belgien
 Herenveld 2
 B - 9500 Geraadsbergen
 Fon: 0032/54437860
 Fax: 0032/54437898
 Mail: vb.belgien@keb.de
- BOL** Ergovial Ltda.
 AV. Banzer Km 6, 5
 BOL - Santa Cruz
 Fon: 00591/33/443349
 Fax: 00591/33/426841
 Mail: santivanez@cotas.com.bo
 I-Net: www.ergovial.com.bo
- BR** Brastronic
 Comercio e Servicos Ltda
 Rua Constantino de Souza 184
 BR - CEP 04605-000
 Campo Belo Sao Paulo
 Fon: 0055/11/55633101
 Fax: 0055/11/55633101
- CH** Stamm Industrieprodukte AG
 Hofstraße 106
 CH - 8620 Wetzikon
 Fon: 0041/1/9346010
 Fax: 0041/1/9346039
 Mail: info@stammweb.ch
 I-Net: www.stammweb.ch
- CHN** KEB China
 Karl E. Brinkmann GmbH
 Shanghai Representative Office
 Far East International Pl. B1210-1211
 No. 299 Xianxia Road
 CHN - 200051 Shanghai, PR. China
 Fon: 0086/21/62350922
 0086/21/52574020
 Fax: 0086/21/62350015
 Mail: info@keb-cn.com
 I-Net: www.keb-cn.com
- CZ** KEB Antriebstechnik Austria GmbH
- Organizacni slozka
 Kostelini 32/1226
 CZ - 370 04 Ceske Budejovice
 Fon: 00420/38/7319223
 Fax: 00420/38/7330697
- DK** REGAL A/S
 Industrievvej 4
 DK - 4000 Roskilde
 Fon: 0045/4677/7000
 Fax: 0045/4675762
 Mail: regal@regal.dk
 I-Net: www.regal.dk
- E** ELION S.A.
 Farell 9
 E - 08014 Barcelona
 Fon: 0034/93/2982000
 Fax: 0034/93/4314133
 Mail: elion@elion.es
 I-Net: www.elion.es
- ET** Tarek El Sehelly
 P.o.Box 83
 ET - Mehalla El Kobra
 Fon: 0020/402243839
 Fax: 0020/402235753
- F** Société Francaise KEB
 Z.I. de la Croix St. Nicolas
 14, rue Gustave Eiffel
 F - 94510 LA QUEUE EN BRIE
 Fon: 0033/1/49620101
 Fax: 0033/1/45767495
 Mail: sfkeb.4@wanadoo.fr
- FIN** Advancetec Oy
 Malminkaari 10 B
 PL 149
 FIN - 00701 Helsinki
 Fon: 00358/9/3505260
 Fax: 00358/9/35052660
 Mail: juha.frestadius@advancetec.fi
 I-Net: www.advancetec.fi
- GB** KEB (UK) Ltd.
 6 Chieftain Business Park
 Morris Close
 Park Farm, Wellingborough
 GB - Northants, NN8 6 XF
 Fon: 0044/1933/402220
 Fax: 0044/1933/400724
 Mail: info@keb-uk.co.uk
 I-Net: www.keb-uk.co.uk
- GR** ELMO L.T.D.
 Power Transmission & Engineering
 18, Athinon
 GR - 18540 Piraeus
 Fon: 0030/1/4120150
 Fax: 0030/1/4176319
 Mail: elmoltd@ath.forthnet.gr
 I-Net: www.elmo-gr.com
- I** KEB Italia S.r.l.
 Via Newton, 2
 I - 20019 Settimo Milanese (Milano)
 Fon: 0039/02/33500782
 0039/02/33500814
 Fax: 0039/02/33500790
 Mail: kebitalia@keb.it
 I-Net: www.keb.it
- IL** OMEGA Engineering Ltd.
 P.O. Box 1092
 IL - 44110 Kfar-Saba
 Fon: 00972/9/7673240
 Fax: 00972/9/7673398
 Mail: info@omegae.co.il
 I-Net: www.omegae.co.il
- IND** PEASS INDUSTRIAL ENG. LTD.
 Merchant Chambers, 2nd Floor
 41, New Marine Lines
 IND - Bombay 400020
 Fon: 0091/22/2310561 bis 566
 Fax: 0091/22/2310570
 Mail: peass.ahd@psindia.com
- J** KEB - YAMAKYU Ltd.
 15 - 16, 2 - Chome
 Takanawa Minato-ku
 J - Tokyo 108 - 0074
 Fon: 0081/33/445-8515
 Fax: 0081/33/445-8215
 Mail: kebjt001@d4.dion.ne.jp
- J** KEB - YAMAKYU Ltd.
 711, Fukudayama, Fukuda
 J - Shinjo-Shi, Yamagata 996 - 0053
 Fon: 0081/233/29-2800
 Fax: 0081/233/29-2802
 Mail: kebjt001@d4.dion.ne.jp
- LV** Energy Line
 Ranka Dambis1, Riga
 Lativa, LV - 1048
 Fon: 00371/7317619090
 Fax: 00371/7317619023
 Mail: world@pta-discount.com
- NL** Marsman Elektronica
 En Aandrijvingen BV
 Zeearend 16
 NL - 7609 PT Almelo
 Fon: 0031/546/812121
 Fax: 0031/546/810655
 Mail: info@marsman-almelo.nl
 I-Net: www.marsman-almelo.nl
- NZ** Renold New Zealand Limited
 P.O. Box 19460
 NZ - Avondale Auckland
 Fon: 0064/9/8285018
 Fax: 0064/9/8285019
 Mail: aksales@renold.co.nz
 I-Net: www.renold.co.nz

- NZ** Vectek Electronics Ltd.
21 Carnegie Road, Onekawa
NZ - Napier
Fon: 0064/6/8431400
Fax: 0064/6/8430398
Mail: info@vectek.co.nz
I-Net: www.vectek.co.nz
- P** KEB Portugal
Lugar de Salgueiros–Pavilhao A
Mouquim
P - 4760 V. N. Famalicao
Fon: 00351/252/371 318
Fax: 00351/252/371 320
Mail: keb.portugal@netc.pt
- PA** Associated Textile Consultants (ATC)
Private LTD
219, The Forum, G-20, Block-9
Khayaban-e-Jami, Clifton
PA - 75600 Karachi
Fon: 0092-21-5821241 ... 6
Fax: 0092-21-5821559 / 5821247
Mail: atcl@cyber.net.pk
- RA** Eurotrans S.r.l.
Sarmiento 2759
San Fernando B 1646 EDE
RA - Pcia. de Buenos Aires
Fon: 0054/11/4744-3366
Fax: 0054/11/4744-3366
Mail: eurotrans@escape.com.ar
I-Net: www.eurotrans.com.ar
- RCH** EMET LTDA.
El Libano #2770, Macul
RCH - Santiago, Chile
Fon: 0056/2/2712147
Fax: 0056/2/2710317
Mail: emet@entelchile.net
I-Net: www.emet.cl
- ROC** KEB Taiwan Ltd.
1 F, No. 19-5, Shi Chou Rd,
Tounan Town
R.O.C. - Yin-Lin Hsian, Taiwan
Fon: 00886/5/596 4242
Fax: 00886/5/596 4240
Mail: keb_taiwan@mail.apol.com.tw
- ROM** ADF Industries srl
Bucarest Sec. 3, Str. Baraj Bicaz
Nr.2 – 4, M25 Ap 110
PO 74661
ROM - Bucarest
Fon: 0040/1/94347138
Fax: 0040/1/3403224
Mail: floria@hades.ro
- RSA** P E C S Pneumatic Electric
Control Systems (PTY) Ltd.
P.O. Box 47396
8, Balance Road, Stamford Hill 4001
RSA - Durban / Greyville 4023
Fon: 0027/31/3033701
Fax: 0027/31/3127421
Mail: pecs@mweb.co.za
I-Net:
www.pecs.powertransmission.co.za
- RUS** FRUCTONADE Engineering Ltd.
ul. Vyborgskaya 22 of 62
RUS - 125130 Moskow / Russia
Fon: 007/095/797-8856
Fax: 007/095/450-0165
007/095/450-0043
Mail: privod@fructonad.ru
- S** REVA - drivteknik AB
Slussgatan 13
S - 21130 Malmö
Fon: 0046/4077110
Fax: 0046/4079994
Mail: info@revadrivteknik.se
I-Net: www.revadrivteknik.se
- THA** INNOTECH Solution Co. Ltd.
518 Nec Building, 5th Floor
Ratchadapisek Road
THA - Huaykwang, 10320 Bangkok
Fon: 0066/2/5414130
Fax: 0066/2/5414129
Mail: innotech@bkk.a-net.net.th
- TN** H 2 M
13, Rue El Moutanabi
TN - 2037, El Menzah 7
Fon: 00216/1/860808
Fax: 00216/1/861433
Mail: h2m.tech@planet.tn
- TR** MEGA Mekanik Ve Elektrik Güc
Aktarma San. Ve Tic., Ltd. Sti
Acisu Sok 9/11 D4
TR - Macka Istanbul
Fon: 0090/212/2596979
Fax: 0090/212/2599815
- TR** TEPEKS Elektronik Sanayi Ve
Ticaret Ltd. Sirketij
Harman Cad. Ali Kaya Sok. No. 4
POLAT Plaza B. Blok Kat 5
TR - 80640 Levent, Istanbul
Fon: 0090/212/3252530
Fax.: 0090/212/3252535
Mail: tepeks@tepeks.com
I-Net: www.tepeks.com
- UA** MARKET-K
Of. 2, 62 B, Vishnevetskogo Str.
UA – 257002 Cherkassy
Fon: 00380/472/540617
Fax: 00380/472/540614
Mail: market-k@market-
k.cherkassy.ua
- USA** KEBCO Inc.
- 1335 Mendota Heights Road
USA - Mendota Heights, MN 55120
Fon: 001/651/4546162
Fax: 001/651/4546198
Mail: info@kebco.com
I-Net: www.kebco.com
- UZ** Mehatronika-TES
Str. Druzhba Narodov, 52
UZ - 700135 Tashkent
Fon: 00998/71/1167316
Fax: 00998/71/1167316
Mail: mtes@online.ru
- 07/2001

Chapter 12	Section 1	Page 8	Date 07.02.02	Name: Basis KEB COMBIVERT F5-G / B	© KEB Antriebstechnik, 2002 All Rights reserved
----------------------	---------------------	------------------	------------------	--	--

12.1.3 Domestic Representations

**teilweise
Sachsen und
Thüringen**

KEB Antriebstechnik GmbH & Co. KG
Wildbacher Straße 5
08289 Schneeberg
Tel.: (0 37 72) 67-0
Fax: (0 37 72) 6 72 81
E-mail: info@keb-combidrive.de

**Brandenburg
Mecklenburg-Vorp.
Sachsen-Anhalt
teilweise Sachsen
und Thüringen**

Schumer Ingenieurgesellschaft mbH
Gottschallstraße 11
04157 Leipzig
Tel.: (03 41) 9 12 95 11
Fax: (03 41) 9 12 95 39
E-mail: info@schumer.de
Internet: www.schumer.de

**Hamburg
Schleswig-Holstein
Bremen
teilweise
Niedersachsen**

KEB Antriebstechnik
Vertrieb Nord
Knüll 9a
21698 Bargstedt
Tel.: (0 41 64) 62 33
Fax: (0 41 64) 62 55
E-mail: vb.nord@keb.de
Internet: www.keb.de

**NRW Ost
teilweise
Niedersachsen**

KEB-Antriebstechnik
Vertrieb West
Gartenstraße 18
33775 Versmold
Tel.: (0 54 23) 94 72-0
Fax: (0 54 23) 94 72-20
E-mail: vb.west@keb.de
Internet: www.keb.de

NRW West

Ing. Büro für rationelle Antriebe
Horst Thomalla GmbH
Vorsterstraße 448
41169 Mönchengladbach
Tel.: (0 21 61) 55 62 62
Fax: (0 21 61) 55 78 68
E-mail: horst.thomalla.gmbh@t-online.de

**Hessen
teilweise
Rheinland-Pfalz**

KEB Antriebstechnik
Vertrieb Süd-West
Diesterwegstraße 8 B
35745 Herborn
Tel.: (0 27 72) 92 42-0
Fax: (0 27 72) 92 42-28
E-mail: vb.suedwest@keb.de
Internet: www.keb.de

**Baden-Württ.
Saarland
teilweise
Rheinland-Pfalz**

Laipple / Brinkmann GmbH
Ziegelhau 13
73099 Adelberg
Tel.: (0 71 66) 9 10 01-0
Fax: (0 71 66) 9 10 01-26
E-mail: info@laipple-keb.de
Internet: laipple-keb.de

Bayern Süd

KEB Antriebstechnik
Vertrieb Süd
Büro Schwindegg
Wehrstraße 3
84419 Schwindegg
Tel.: (0 80 82) 57 32 + 58 37
Fax: (0 80 82) 57 30
E-mail: vb.sued1@keb.de
Internet: www.keb.de

KEB Antriebstechnik
Vertrieb Süd
Büro Nürnberg
Haidelbacher Straße 2
91227 Leinburg
Tel.: (0 91 20) 62 87
Fax: (0 91 20) 62 75
E-mail: vb.sued2@keb.de
Internet: www.keb.de



Karl E. Brinkmann GmbH

Försterweg 36 - 38 • D - 32683 Bartrup
Telefon 00 49 / 52 63 / 4 01 - 0 • Fax 00 49 / 52 63 / 4 01 - 1 16
Internet: www.keb.de • E-mail: info@keb.de

KEB Antriebstechnik GmbH & Co. KG

Wildbacher Str. 5 • D - 08289 Schneeberg
Telefon 0049 / 37 72 / 67 - 0 • Telefax 0049 / 37 72 / 67 - 2 81
E-mail: info@keb-combidrive.de

KEB Antriebstechnik Austria GmbH

Ritzstraße 8 • A - 4614 Marchtrenk
Tel.: 0043 / 7243 / 53586 - 0 • FAX: 0043 / 7243 / 53586 - 21
Kostelni 32/1226 • CZ - 370 04 České Budejovice
Tel.: 00420 / 38 / 731 92 23 • FAX: 00420 / 38 / 733 06 97
E-mail: info@keb.at

KEB Antriebstechnik

Herenveld 2 • B - 9500 Geraadsbergen
Tel.: 0032 / 5443 / 7860 • FAX: 0032 / 5443 / 7898
E-mail: koen.detaeye@keb.de

KEB China

Xianxia Road 299 • CHN - 200051 Shanghai
Tel.: 0086 / 21 / 62350922 • FAX: 0086 / 21 / 62350015
Internet: www.keb-cn.com • E-mail: info@keb-cn.com

Société Française KEB

Z.I. de la Croix St. Nicolas • 14, rue Gustave Eiffel
F - 94510 LA QUEUE EN BRIE
Tél.: 0033 / 1 / 49620101 • FAX: 0033 / 1 / 45767495
E-mail: sfkeb.4@wanadoo.fr

KEB (UK) Ltd.

6 Chieftain Business Park, Morris Close
Park Farm, Wellingborough, GB - Northants, NN8 6 XF
Tel.: 0044 / 1933 / 402220 • FAX: 0044 / 1933 / 400724
Internet: www.keb-uk.co.uk • E-mail: info@keb-uk.co.uk

KEB Italia S.r.l.

Via Newton, 2 • I - 20019 Settimo Milanese (Milano)
Tel.: 0039 / 02 / 33500782 • FAX: 0039 / 02 / 33500790
Internet: www.keb.it • E-mail: kebitalia@keb.it

KEB - YAMAKYU Ltd.

15 - 16, 2 - Chome, Takanawa Minato-ku
J - Tokyo 108 -0074
Tel.: 0081 / 33 / 445-8515 • FAX: 0081 / 33 / 445-8215
E-mail: kebjt001@d4.dion.ne.jp

KEB Portugal

Lugar de Salgueiros - Pavilhao A, Mouquim
P - 4760 V. N. de Famalicao
Tel.: 00351 / 252 / 371 318 • FAX: 00351 / 252 / 371 320
E-mail: keb.portugal@netc.pt

KEB Taiwan Ltd.

1F, No.19-5, Shi Chou Rd., Tounan Town
R.O.C. - Yin-Lin Hsian / Taiwan
Tel.: 00886 / 5 / 5964242 • FAX: 00886 / 5 / 5964240
E-mail: keb_taiwan@mail.apol.com.tw

KEBCO Inc.

1335 Mendota Heights Road
USA - Mendota Heights, MN 55120
Tel.: 001 / 651 / 4546162 • FAX: 001 / 651 / 4546198
Internet: www.kebco.com • E-mail: info@kebco.com